

**F i s c h b a c h**  
**Transportation Group, LLC**  
**Traffic Engineering and Planning**

## **Traffic Impact Study**

**Crescent Resources Centre (Bigby)**  
**Carothers Parkway and E. McEwen Drive**  
**Franklin, TN**

Prepared November 2016  
For Crescent Communities

FTG, LLC  
P.O. Box 682736  
Franklin, TN 37068  
(615) 771-8022 phone  
Gillian@FTGtraffic.com

## Traffic Impact Study

# Crescent Resources Centre (Bigby) Carothers Parkway and E. McEwen Drive

Franklin, Tennessee

Prepared November 2016

**PREPARED FOR:**

Crescent Communities, LLC  
227 W. Trade St, Suite 1000  
Charlotte, NC 28202

**PREPARED BY:**

Ms. Gillian L. Fischbach, P.E., PTOE  
Fischbach Transportation Group (FTG, LLC)  
P.O. Box 682736  
Franklin, TN 37068  
Phone: (615) 771-8022  
FTG Project Number: 10765



## Table of Contents

1. INTRODUCTION .....	4
2. PROJECT DESCRIPTION.....	5
FIGURE 1. LOCATION OF THE PROJECT SITE.....	6
FIGURE 2. CURRENT PROJECT SITE PLAN .....	7
3. EXISTING TRAFFIC VOLUMES .....	8
FIGURE 3. EXISTING LANEAGE WITHIN THE STUDY AREA.....	10
FIGURE 4. EXISTING PEAK HOUR TRAFFIC VOLUMES.....	11
TABLE 1. DESCRIPTIONS OF LOS FOR SIGNALIZED INTERSECTIONS .....	12
TABLE 2. DESCRIPTIONS OF LOS FOR UNSIGNALIZED INTERSECTIONS .....	13
TABLE 3. EXISTING PEAK HOUR LEVELS OF SERVICE.....	14
4. PROJECTION OF BACKGROUND TRAFFIC VOLUMES .....	16
FIGURE 5A. PEAK HOUR TRAFFIC GENERATED BY OVATION.....	18
FIGURE 5B. PEAK HOUR TRAFFIC GENERATED BY GREENWAY CENTER .....	19
FIGURE 5C. PEAK HOUR TRAFFIC GENERATED BY FRANKLIN PARK .....	20
FIGURE 5D. BACKGROUND PEAK HOUR TRAFFIC VOLUMES.....	21
TABLE 5. BACKGROUND PEAK HOUR LEVELS OF SERVICE.....	22
5. IMPACTS OF PROPOSED DEVELOPMENT .....	24
5.1 TRIP GENERATION .....	24
TABLE 6. TRIP GENERATION FOR THE PROPOSED PROJECT .....	24
5.2 TRIP DISTRIBUTION AND TRAFFIC ASSIGNMENT.....	26
FIGURE 6. DIRECTIONAL DISTRIBUTION OF SITE TRAFFIC.....	27
FIGURE 7. PEAK HOUR TRAFFIC VOLUMES GENERATED BY THE PROJECT.....	28
5.3 CAPACITY ANALYSES.....	29
FIGURE 8. TOTAL PROJECTED PEAK HOUR TRAFFIC VOLUMES.....	31
TABLE 7. PROJECTED PEAK HOUR LEVELS OF SERVICE.....	32
5.4 CAPACITY ANALYSIS COMPARISON .....	34
TABLE 8. COMPARISON OF AM PEAK HOUR LEVELS OF SERVICE .....	34
TABLE 9. COMPARISON OF PM PEAK HOUR LEVELS OF SERVICE.....	34
6. CONCLUSIONS AND RECOMMENDATIONS .....	35
APPENDIX A.....	36
APPENDIX B .....	40

APPENDIX C .....55  
APPENDIX D .....193

## 1. INTRODUCTION

This traffic study has been prepared in order to identify the traffic impacts of a mixed-use development that is proposed to be constructed in the northeast quadrant of the intersection of E. McEwen Drive and Carothers Parkway in Franklin, Tennessee. Specifically, the project site is bounded by E. McEwen Drive, Carothers Parkway, Pacific Drive, and Resource Parkway.

For the purposes of this study, existing and background traffic volumes were established, and capacity analyses were conducted for these conditions. Also, trip generation calculations were performed, and the trips which are expected to be generated by the proposed project were distributed to the roadway system and added to the background traffic volumes. The roadways and intersections which provide access to the site were then re-evaluated to determine the traffic impacts of the proposed project. Access needs for the project were evaluated, and the necessary roadway and/or traffic control improvements were identified. This report presents the results of these analyses and the subsequent recommendations.

It is important to note that the scope of this Traffic Impact Study was provided by the City of Franklin Engineering Department and their third-party private consultant, Volkert, Inc. The approved scope is included in in [Appendix A](#).

## 2. PROJECT DESCRIPTION

The location of the proposed project is shown in [Figure 1](#). As shown, the project site is located in the northeast quadrant of the intersection of E. McEwen Drive and Carothers Parkway in Franklin, Tennessee. Specifically, the project site is bounded by E. McEwen Drive, Carothers Parkway, Pacific Drive, and Resource Parkway.

The current project site plan is shown in [Figure 2](#). As shown, the proposed plan includes the following land uses:

- 325 apartments,
- 15 townhomes,
- 300,000 sq.ft. of office space
- A hotel with 200 rooms
- 50,000 sq.ft. of specialty retail space

Access to the site will be provided by Pacific Drive and Resource Drive, as shown in the site plan.

In large part, economic and market considerations will dictate the pace and timing with which the proposed project is actually completed. The analyses conducted within this study are based on the estimation that the entire project will be completed within six years.

F i s c h b a c h  
Transportation Group, LLC  
Traffic Engineering and Planning

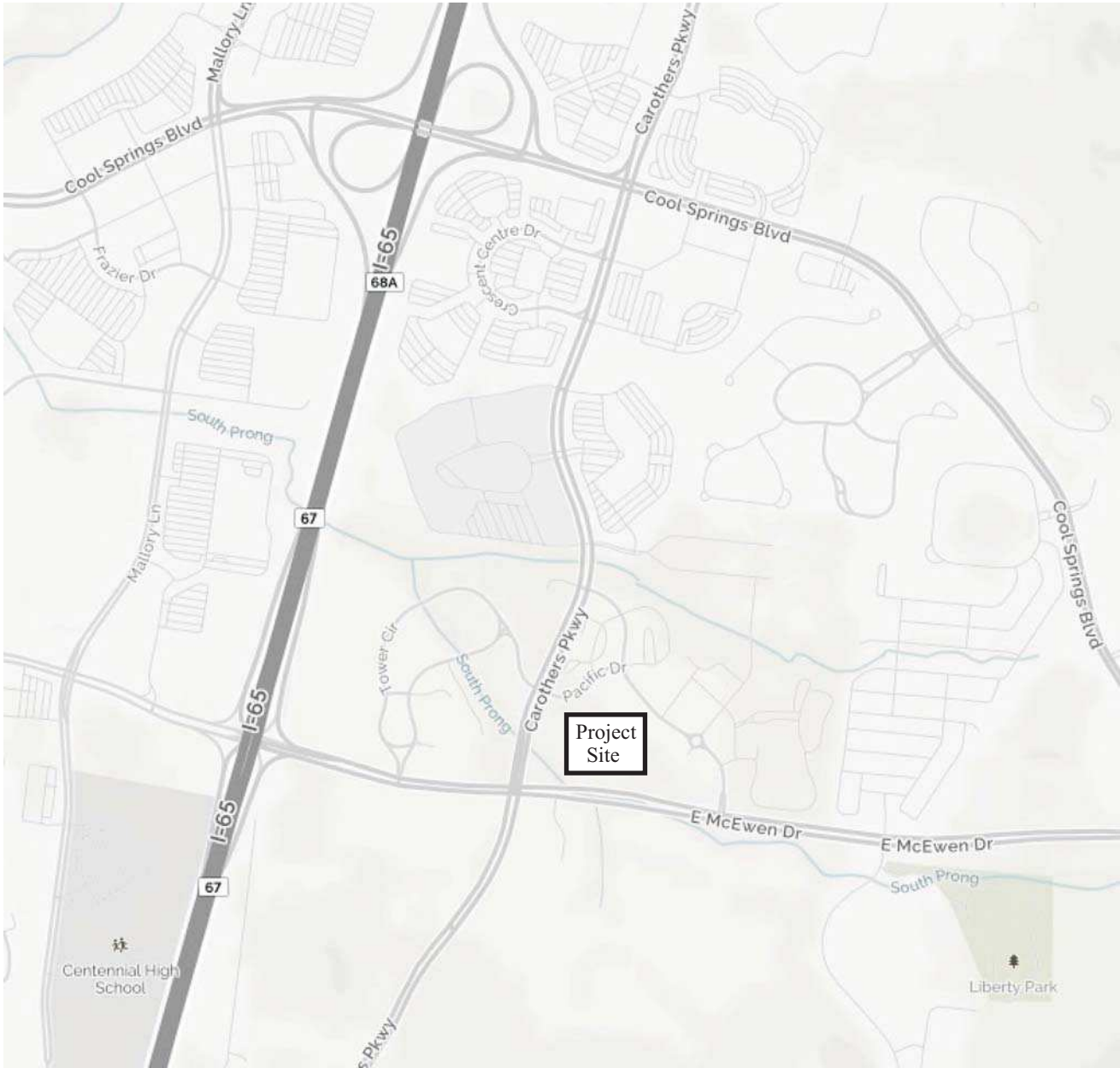

No Scale

Figure 1.  
Location of the Project Site



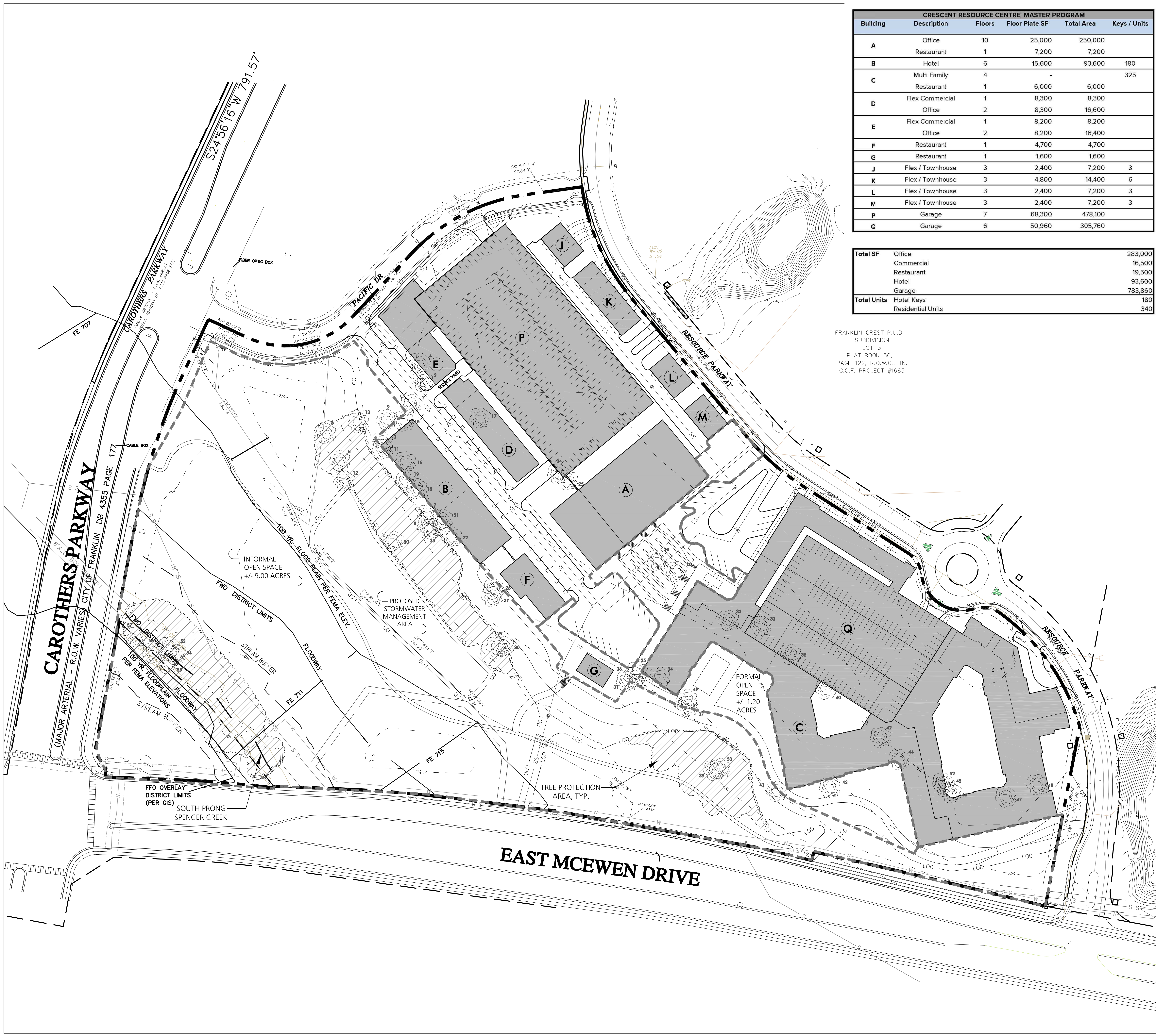

CRESCENT RESOURCE CENTRE MASTER PROGRAM					
Building	Description	Floors	Floor Plate SF	Total Area	Keys / Units
A	Office	10	25,000	250,000	
	Restaurant	1	7,200	7,200	
B	Hotel	6	15,600	93,600	180
C	Multi Family	4	-	-	325
	Restaurant	1	6,000	6,000	
D	Flex Commercial	1	8,300	8,300	
	Office	2	8,300	16,600	
E	Flex Commercial	1	8,200	8,200	
	Office	2	8,200	16,400	
F	Restaurant	1	4,700	4,700	
G	Restaurant	1	1,600	1,600	
J	Flex / Townhouse	3	2,400	7,200	3
K	Flex / Townhouse	3	4,800	14,400	6
L	Flex / Townhouse	3	2,400	7,200	3
M	Flex / Townhouse	3	2,400	7,200	3
P	Garage	7	68,300	478,100	
Q	Garage	6	50,960	305,760	

<b>Total SF</b>	Office	283,000
	Commercial	16,500
	Restaurant	19,500
	Hotel	93,600
	Garage	783,860
<b>Total Units</b>	Hotel Keys	180
	Residential Units	340

FRANKLIN CREST P.U.D.  
SUBDIVISION  
LOT-3  
PLAT BOOK 50,  
PAGE 122, R.O.W.C., TN.  
C.O.F. PROJECT #1683

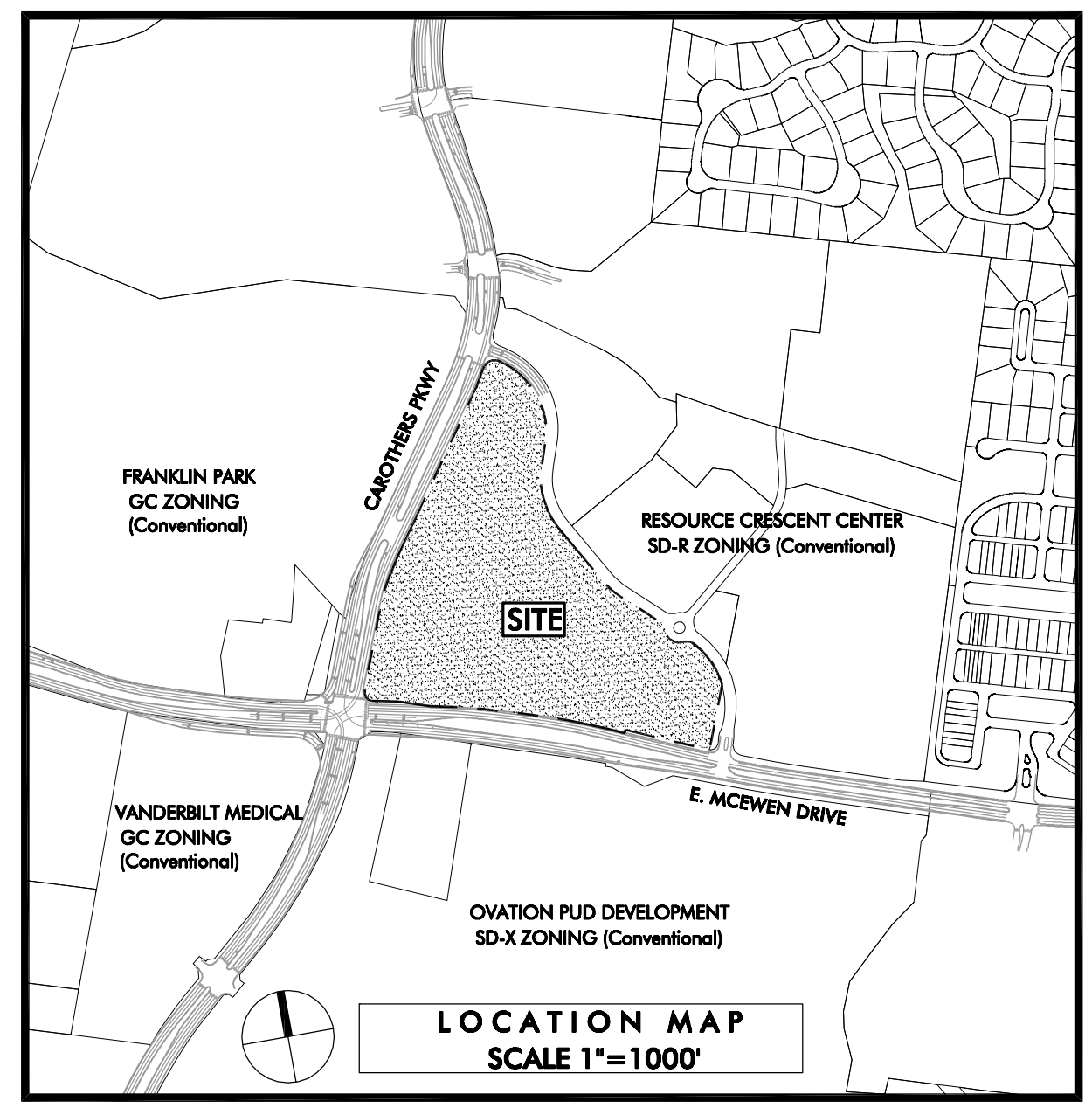

**SITE DATA**

SUBDIVISION/DEVELOPMENT	CRESCENT RESOURCE CENTRE
EXISTING ZONING	GC - GENERAL COMMERCIAL
MAP & PARCEL NUMBER	MAP 062, PARCELS 01417 & 01418
ADDRESS	CAROTHERS PARKWAY
PROPOSED ZONING	SD-X
CHARACTER AREA	MC EWEN
SPECIAL AREA	4
OTHER APPLICABLE OVERLAYS	FLOODWAY FRINGE OVERLAY (FFO) FLOODWAY OVERLAY DISTRICT (FWO)
DEVELOPMENT STANDARD	CONVENTIONAL
ACREAGE OF SITE	+/- 23.61 ACRES
EXISTING TREE CANOPY	+/- 7.48 ACRES (32% OF SITE)
MIN. AREA OF EXISTING TREE CANOPY TO PRESERVE	+/- 1.80 ACRES (24% OF EXISTING CANOPY)
AREA OF PRESERVED TREE CANOPY	+/- 1.35 ACRES (18% OF EXISTING CANOPY)

- NOTES:**
- DEVELOPER TO RETAIN ALL MINERAL RIGHTS.
  - NO STRUCTURES CURRENTLY EXIST ON SITE
  - THERE ARE NO HISTORIC STRUCTURES WITHIN 500' OF THE SITE

FORMAL OPEN SPACE - REQUIRED	+/- 1.18 ACRES (5% OF GROSS DEVELOPMENT SIZE)
FORMAL OPEN SPACE - PROVIDED	+/- 1.20 ACRES (5% OF GROSS DEVELOPMENT SIZE)
INFORMAL OPEN SPACE - REQUIRED	NONE
INFORMAL OPEN SPACE - PROVIDED	+/- 9.00 ACRES (38% OF GROSS DEVELOPMENT SIZE)

- APPLICANT IS REQUESTING A MODIFICATION OF STANDARDS FOR THE FOLLOWING:
- ITEM 5.2.4 (3) TREE CANOPY RETENTION REQUIREMENT = 24% OF EXISTING TREE CANOPY TO BE RETAINED
  - ITEM 5.3.5 (3)(b) (ii) RESIDENTIAL DEVELOPMENT REQUIREMENT = MAXIMUM LENGTH OF ANY ATTACHED RESIDENTIAL BUILDING SHALL BE 200 FEET.

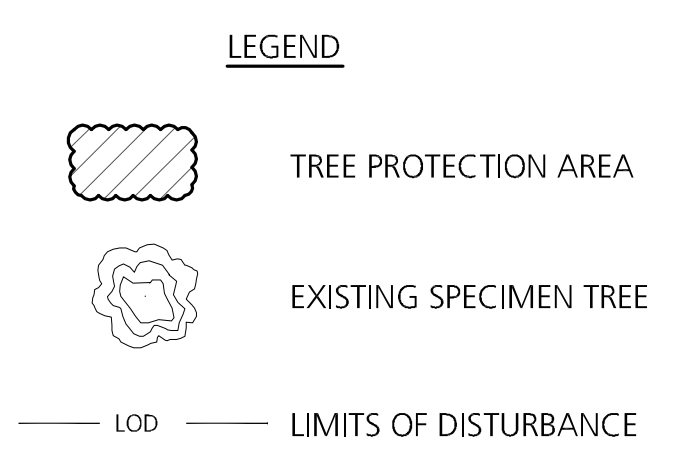

ENGINEERING PROVIDED BY:  
RYAN MCMASTER  
KIMLEY-HORN  
214 OCEANSIDE DRIVE  
NASHVILLE, TN 37204  
(615) 564-2876  
ryan.mcmaster@kimley-horn.com

APPLICANT:  
JOHN HAAS  
EDGE  
210 12TH AVE. SOUTH  
SUITE 202  
NASHVILLE TN, 37203  
(615) 250-8154  
jhaas@edgela.com

DEVELOPER:  
CHRIS PASCARELLA  
CRESCENT COMMUNITIES  
205 POWELL AVENUE  
BRIGHTWOOD, TN 37027  
(615) 312-8242  
kpascarella@pearlstreetpartners.com

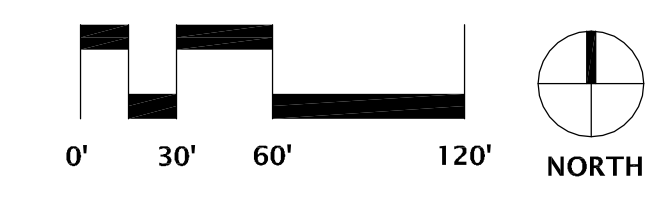

CONSULTANTS



PROJECT TITLE  
**RESOURCE CENTRE - SECTION 1, LOTS 1 & 2  
PUD DEVELOPMENT PLAN  
PRE-APPLICATION  
C.O.F. #XXXX  
FRANKLIN, TN**

CLIENT  
**CRESCENT  
COMMUNITIES  
LLC**

PROJECT NO. 0X-XXX.X  
Date 09/23/16  
Revisions

Sheet Title

DEVELOPMENT  
PLAN

Sheet Number



### 3. EXISTING TRAFFIC VOLUMES

In order to quantify the impact of the traffic that will be generated by the proposed project, peak hour traffic volumes were counted at the following locations:

1. McEwen Drive and the Ramps for I-65
2. E. McEwen Drive and Tower Circle
3. E. McEwen Drive and Carothers Parkway
4. E. McEwen Drive and Resource Parkway
5. Carothers Parkway and Tower Circle / Pacific Drive
6. Carothers Parkway and Apartments / Resource Parkway

This data was collected during the morning and evening peak hours on typical weekdays when schools were in session. The raw traffic volumes are included in [Appendix B](#). The existing laneage at the intersections within the study area is shown in [Figure 3](#), and the existing peak hour traffic volumes are shown in [Figure 4](#).

Using the existing peak hour traffic volumes shown in [Figure 4](#), capacity analyses were conducted for the intersections counted. Specifically, in order to identify current peak hour levels of operation within the study area, the capacity calculations were performed according to the methods outlined in the [Highway Capacity Manual 2010 \(HCM2010\)](#). These analyses result in the determination of a Level of Service (LOS), which is a measure of evaluation is used to describe how well an intersection or roadway operates. LOS A represents free flow traffic operations, and LOS F suggests that the traffic demand exceeds the available capacity. In an urbanized area, LOS D is typically considered to be the minimum acceptable LOS. [Table 1](#) presents the descriptions of LOS for signalized intersections, and [Table 2](#) presents the descriptions of LOS for unsignalized intersections.

It is important to note that the City of Franklin Engineering Department provided the Synchro software files that were used to identify existing operations at the signalized intersections within the study area. Specifically, the files were updated to include the most-recent traffic volumes.

The results of the capacity analyses for the existing peak hour traffic volumes are shown in [Table 3](#), and [Appendix C](#) includes the capacity analyses worksheets. In particular, the results of the analyses for the signalized intersections within the study area are as follows:

#### **Intersection of McEwen Drive and the Ramps for I-65**

This intersection operates acceptably during both peak hours. However, the eastbound, westbound, and northbound left turns operate at LOS E during the AM peak hour.

#### **Intersection of E. McEwen Drive and Tower Circle**

This intersection operates acceptably during both peak hours. However, the eastbound left turns operate at LOS E during the AM peak hour.

**Intersection of E. McEwen Drive and Carothers Parkway**

This intersection operates at LOS F during the AM peak hour and LOS C during the PM peak hour. During the AM peak hour, the eastbound left turns, in particular, operate with significant delays and vehicle queues. During the PM peak hour, the southbound through and right turn volumes are significant, and field observations indicate that these queues affect several intersections upstream on Carothers Parkway.

**Intersection of Carothers Parkway and Tower Circle/Pacific Drive**

This intersection operates at LOS B during both peak hours., and the vehicle delays and queues are relatively low.

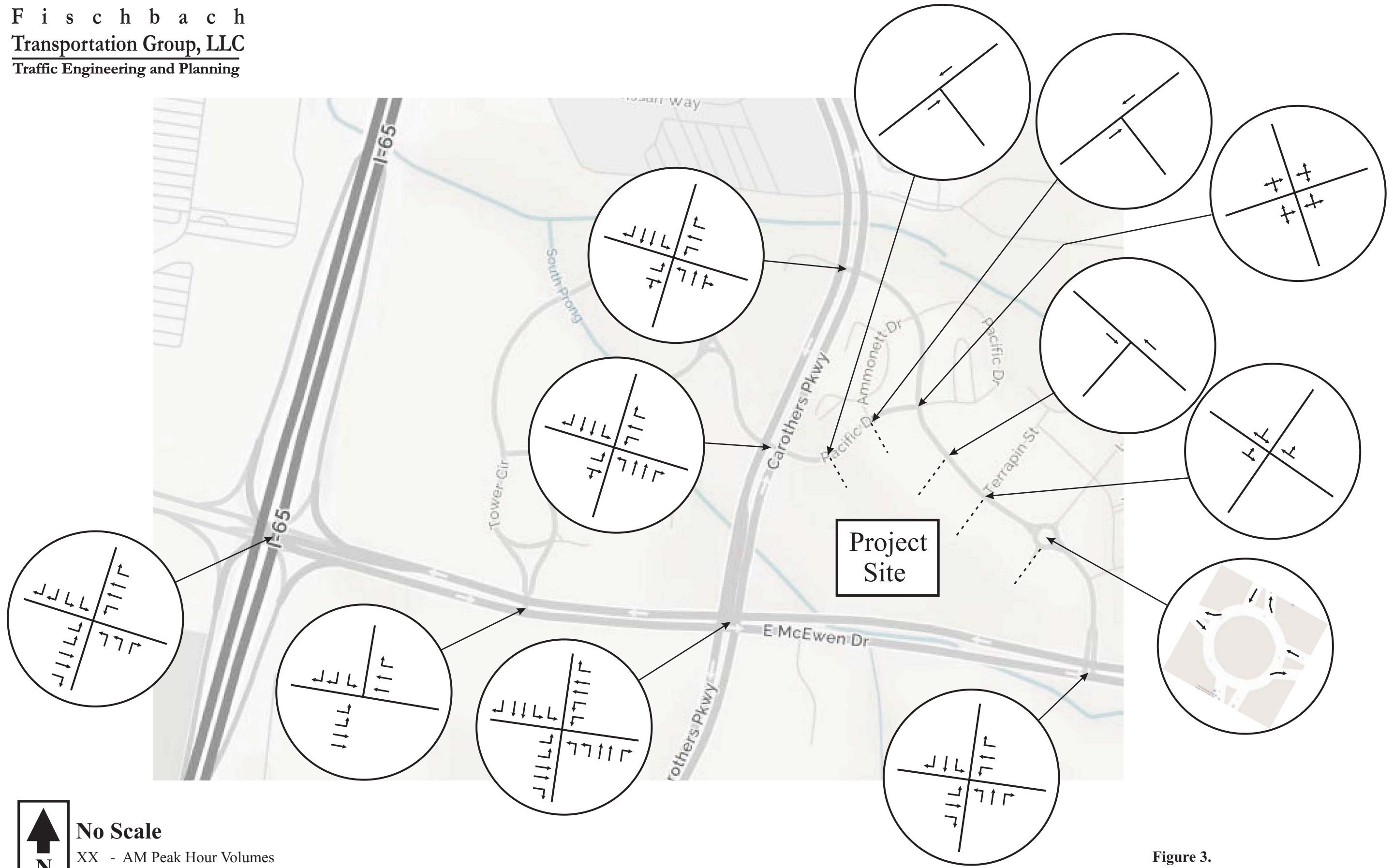

 **No Scale**  
 XX - AM Peak Hour Volumes  
 (XX) - PM Peak Hour Volumes

**Figure 3.**  
 Existing Laneage within the Study Area



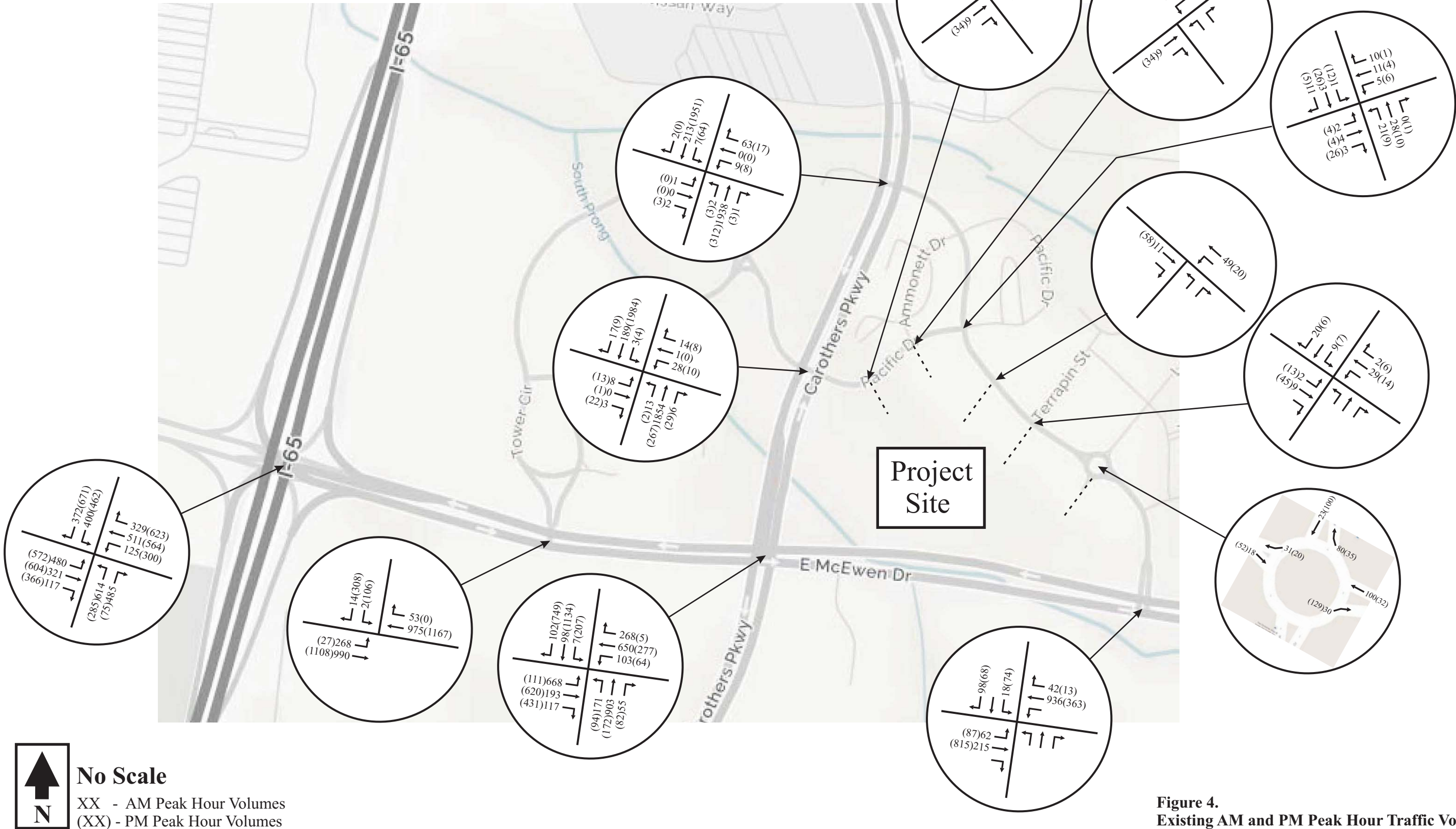

**Figure 4.**  
 Existing AM and PM Peak Hour Traffic Volumes

 **No Scale**  
 XX - AM Peak Hour Volumes  
 (XX) - PM Peak Hour Volumes

**TABLE 1. DESCRIPTIONS OF LOS FOR SIGNALIZED INTERSECTIONS**

<b>Level of Service</b>	<b>Description</b>	<b>Average Control Delay per Vehicle (sec)</b>
A	Operations with very low control delay. Progression is extremely favorable, and most vehicles arrive during the green phase. Most vehicles do not stop at all. Short cycle lengths may also contribute to low delay.	$\leq 10$
B	Operations with stable flows. This generally occurs with good progression, short cycle lengths, or both. More vehicles stop than for LOS A, causing higher levels of average delay.	$> 10$ and $\leq 20$
C	Operations with stable flow. Occurs with fair progression, longer cycle lengths, or both. Individual cycle failures may begin to appear at this level. The number of vehicles stopping is significant, although many still pass through the intersection without stopping.	$> 20$ and $\leq 35$
D	Approaching unstable flow. The influence of congestion becomes more noticeable. Longer delays may result from some combination of unfavorable progression, long cycle lengths, or high v/c ratios. Many vehicles stop.	$> 35$ and $\leq 55$
E	Unstable flow. In many cases, this is considered to be the limit for acceptable delay. These high delays generally indicate poor progression, long cycle lengths, and high v/c ratios.	$> 55$ and $\leq 80$
F	Unacceptable delay. This condition often occurs with oversaturation or with high v/c ratios. Poor progression and long cycle lengths may also cause such delay levels.	$> 80$

Source: Highway Capacity Manual 2010 (HCM2010)

**TABLE 2. DESCRIPTIONS OF LOS FOR UNSIGNALIZED INTERSECTIONS**

<b>Level of Service</b>	<b>Description</b>	<b>Average Control Delay (sec/veh)</b>
A	Minimal delay	$\leq 10$
B	Brief delay	$> 10$ and $\leq 15$
C	Average delay	$> 15$ and $\leq 25$
D	Significant delay	$> 25$ and $\leq 35$
E	Long delay	$> 35$ and $\leq 50$
F	Extreme delay	$> 50$

Source: Highway Capacity Manual 2010 (HCM 2010)



**TABLE 3. EXISTING PEAK HOUR LEVELS OF SERVICE**

INTERSECTION	TURNING MOVEMENT	AM PEAK HOUR		PM PEAK HOUR	
		LEVEL OF SERVICE	95 <sup>TH</sup> %-ILE QUEUE	LEVEL OF SERVICE	95 <sup>TH</sup> %-ILE QUEUE
<b>McEwen Drive and Ramps for I-65</b> (signalized)	<b>Overall Intersection</b>	LOS C (35 sec/veh)		LOS C (24 sec/veh)	
<b>E. McEwen Drive and Tower Drive</b> (signalized)	<b>Overall Intersection</b>	LOS B (14 sec/veh)		LOS B (14 sec/veh)	
<b>E. McEwen Drive and Carothers Parkway</b> (signalized)	<b>Overall Intersection</b>	LOS F (96 sec/veh)		LOS C (35 sec/veh)	
<b>E. McEwen Drive and Resource Parkway</b> (unsignalized)	Eastbound Left Turns	LOS B	1 veh	LOS A	1 veh
	Southbound Left Turns	LOS C	1 veh	LOS C	1 veh
	Southbound Right Turns	LOS B	1 veh	LOS A	1 veh
<b>Carothers Parkway and Tower Circle / Pacific Drive</b> (signalized)	<b>Overall Intersection</b>	LOS B (12 sec/veh)		LOS B (14 sec/veh)	
<b>Carothers Parkway and Resource Parkway</b> (unsignalized)	Northbound Left Turns	LOS A	0 veh	LOS C	0 veh
	Southbound Left Turns	LOS C	0 veh	LOS A	1 veh
	Eastbound Left Turns	LOS D	1 veh	LOS F	0 veh
	Eastbound Thrus/Right Turns	LOS A	0 veh	LOS C	0 veh
	Westbound Left Turns	LOS F	1 veh	LOS D	1 veh
	Westbound Thrus	LOS A	0 veh	LOS A	0 veh
	Westbound Right Turns	LOS D	1 veh	LOS A	1 veh
<b>Resource Parkway and Pacific Drive</b>	Northbound Turning Movements	LOS A	1 veh	LOS A	1 veh

(unsignalized)	Southbound Turning Movements	LOS A	1 veh	LOS A	1 veh
	Eastbound Turning Movements	LOS A	1 veh	LOS A	1 veh
	Westbound Turning Movements	LOS A	1 veh	LOS A	1 veh
<b>Resource Parkway and Terrapin Street</b> (unsignalized)	Eastbound Left Turns / Thrus	LOS A	1 veh	LOS A	1 veh
	Southbound Left and Right Turns	LOS A	1 veh	LOS A	1 veh
<b>Resource Parkway and Lemon Grass Drive</b> (traffic circle)	Eastbound Approach	LOS A	1 veh	LOS A	1 veh
	Westbound Approach	LOS A	1 veh	LOS A	1 veh
	Southbound Approach	LOS A	1 veh	LOS A	1 veh

## 4. PROJECTION OF BACKGROUND TRAFFIC VOLUMES

It is important to note that the following projects have been approved for construction in the immediate vicinity of the project site:

### 1. Ovation

This project is under construction on the south side of E. McEwen Drive at Resource Parkway. In July 2013, RPM Transportation Consultants, LLC prepared traffic analyses for this project, and the peak hour traffic volumes generated by this project are shown in [Figure 5A](#). Also, it is important to note that a traffic signal will be installed at the intersection of E. McEwen Drive and Resource Parkway in conjunction with the Ovation project.

### 2. Greenway Center (Phase 2)

This project is planned for construction on the east side of Carothers Parkway and the northern terminus of Lemon Grass Drive. In November 2007, Wilbur Smith Associates prepared traffic analyses for this project, and the peak hour traffic volumes generated by this project are shown in [Figure 5B](#).

### 3. Franklin Park

This project is planned for construction on the west side of Carothers Parkway at Tower Circle and opposite Resource Parkway. In May 2012, CDM Smith prepared traffic analyses for this project, and the peak hour traffic volumes generated by this project are shown in [Figure 5C](#).

It is important to note that several other projects are under consideration for construction in the vicinity of the project site. Specifically, a mixed-use project called Franklin Summit may be constructed in the southeast quadrant of the intersection on McEwen Drive and the ramps for northbound I-65. However, to date, specific plans for this project have not been prepared, and so trip generation estimates and assignment of peak hour site-generated traffic volumes are not available. Therefore, when the Franklin Summit project progresses, the impacts of that project should be identified based on a specific site plan.

The peak hour traffic volumes shown in [Figures 5A, 5B, and 5C](#) were added to the existing traffic volumes in order to establish the background traffic volumes shown in [Figure 5D](#). Using these background peak hour traffic volumes, capacity analyses were conducted for the intersections within the study area. For these analyses, the following assumptions were made:

- A traffic signal will be installed at the intersection of E. McEwen Drive and Resource Parkway / Ovation.



- A traffic signal will be installed at the intersection of Carothers Parkway and Resource Parkway / apartments.
- All other existing infrastructure will be maintained and no additional improvements will be made.

The results of the capacity analyses for the background peak hour traffic volumes are shown in [Table 5](#), and [Appendix B](#) includes the capacity analyses worksheets. In particular, the results of the analyses for the signalized intersections within the study area are as follows:

#### **Intersection of McEwen Drive and the Ramps for I-65**

This intersection is expected to operate at LOS C during the AM peak hour and LOS F during the PM peak hour. During the AM peak hour, all of the left turns are expected to operate poorly. During the PM peak hour, several turning movements are expected to operate poorly, and the westbound right turns are expected to have significant queue lengths.

#### **Intersection of E. McEwen Drive and Tower Circle**

This intersection is expected to operate at LOS C during the AM peak hour and LOS F during the PM peak hour. During the AM peak hour, the eastbound and southbound left turns are expected to operate at LOS E. During the PM peak hour, several turning movements are expected to operate poorly, and the westbound throughs are expected to have significant queue lengths.

#### **Intersection of E. McEwen Drive and Carothers Parkway**

This intersection is expected to operate at LOS F during both peak hours. During the AM peak hour, all of the left turns, as well as the northbound throughs, are expected to operate poorly. The eastbound left turns, in particular, will have significant delays and vehicle queues. During the PM peak hour, the southbound through and right turn volumes will be significant, and these queues are expected to affect intersections upstream on Carothers Parkway.

#### **Intersection of E. McEwen Drive and Resource Parkway**

This intersection is expected to operate at LOS B during both peak hours., and the vehicle delays and queues are expected to remain relatively low.

#### **Intersection of Carothers Parkway and Tower Circle/Pacific Drive**

This intersection is expected to operate at LOS C during the AM peak hour and LOS F during the PM peak hour. During the PM peak hour, the eastbound left turns and the southbound throughs are expected to have significant queues, and these queues are expected to several intersections upstream on Carothers Parkway.

#### **Intersection of Carothers Parkway and Resource Parkway**

This intersection is expected to operate at LOS B during the AM peak hour and LOS C during the PM peak hour. During the AM peak hour, the southbound lefts are expected to operate poorly. During the PM peak hour, the southbound throughs are expected to have significant queues, and these queues are expected to affect intersections upstream on Carothers Parkway.



**No Scale**  
 ↑  
 N  
 XX - AM Peak Hour Volumes  
 (XX) - PM Peak Hour Volumes

**Figure 5A.**  
 Peak Hour Traffic Volumes Generated by Ovation



No Scale

XX - AM Peak Hour Volumes  
 (XX) - PM Peak Hour Volumes

Figure 5B.  
 Peak Hour Traffic Volumes Generated by  
 Greenway Center (Phase 2)



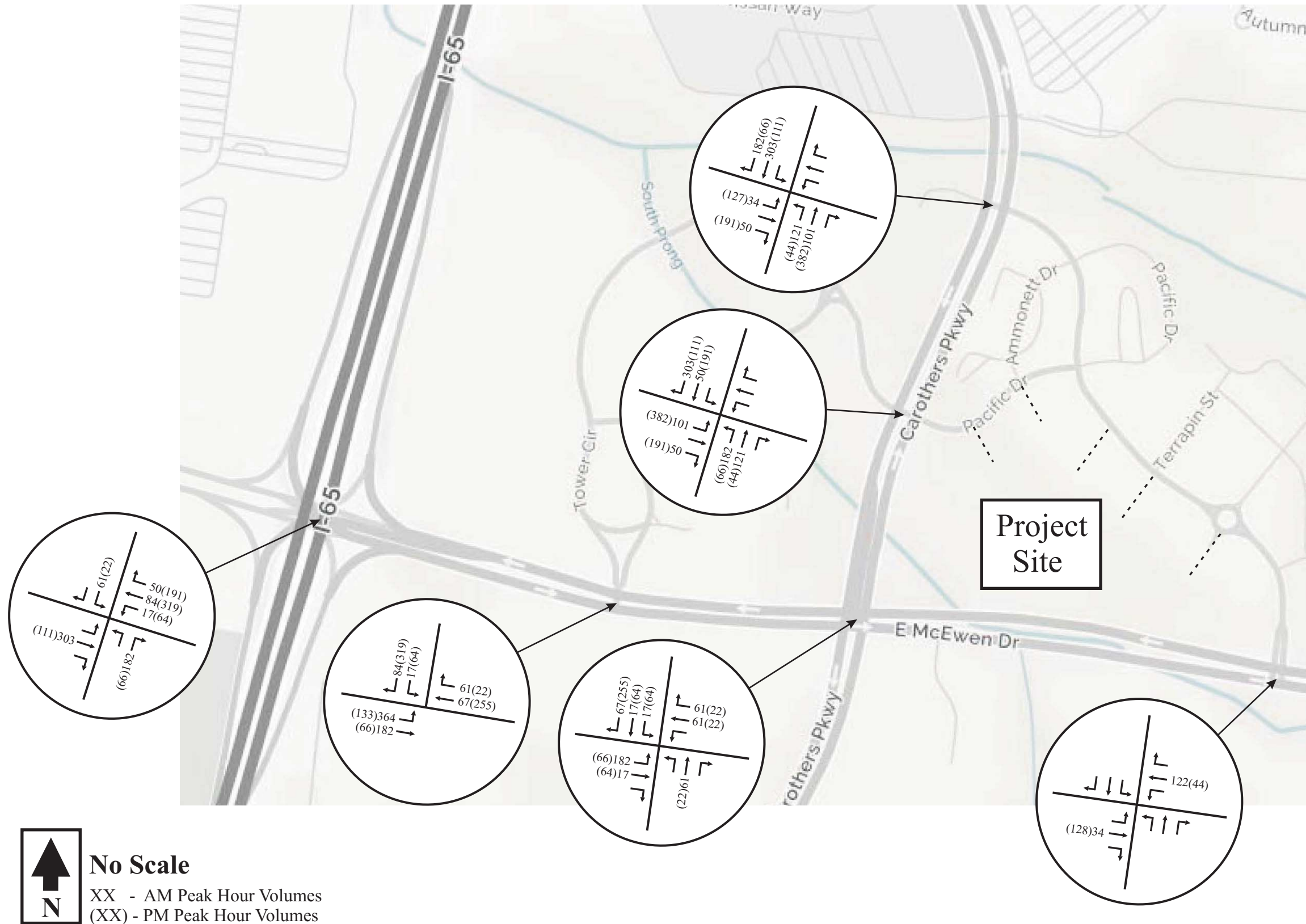
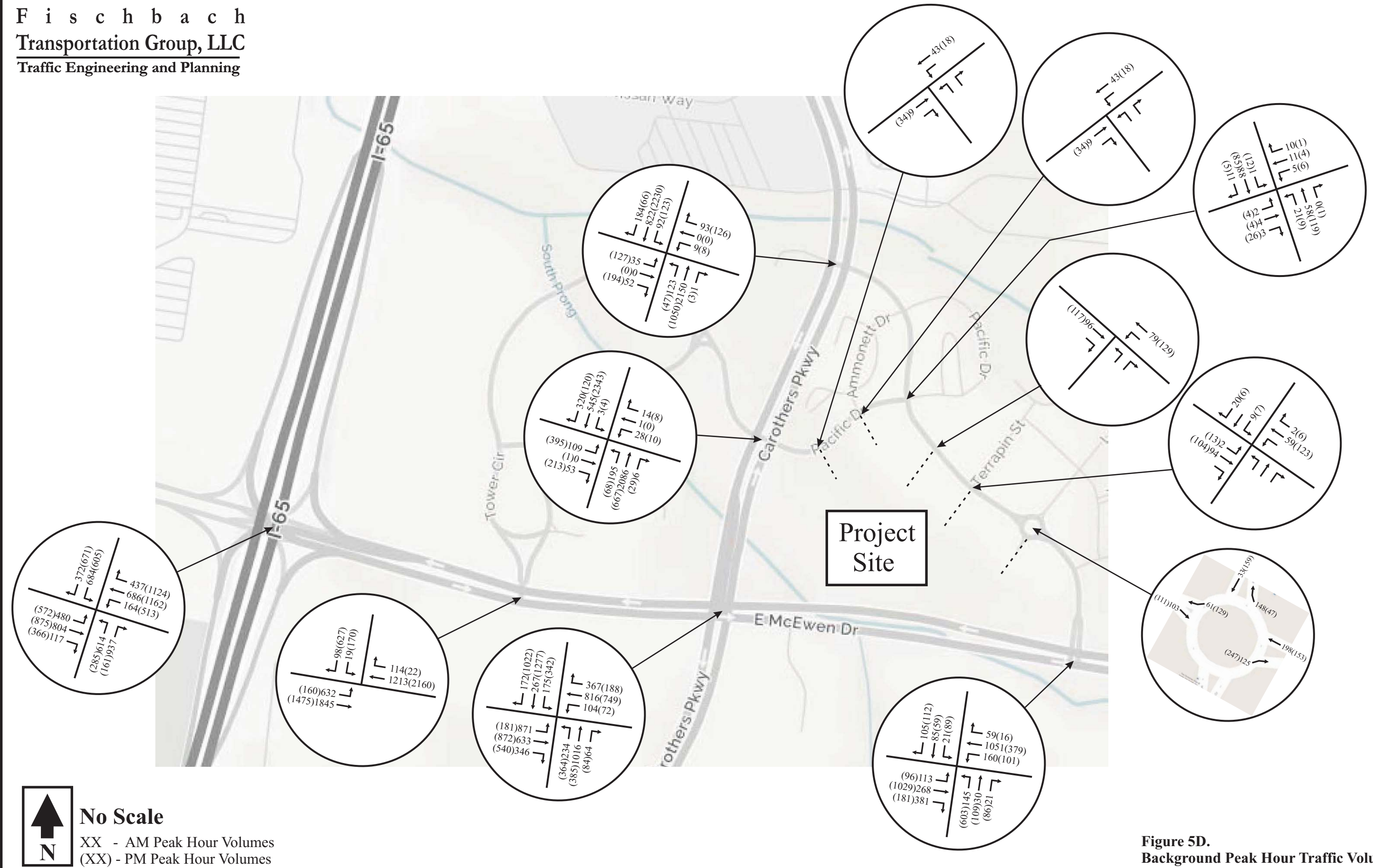

Figure 5C.  
 Peak Hour Traffic Volumes Generated by  
 Franklin Park



**Figure 5D.**  
 Background Peak Hour Traffic Volumes

**TABLE 5. BACKGROUND PEAK HOUR LEVELS OF SERVICE**

INTERSECTION	TURNING MOVEMENT	AM PEAK HOUR		PM PEAK HOUR	
		LEVEL OF SERVICE	95 <sup>TH</sup> %-ILE QUEUE	LEVEL OF SERVICE	95 <sup>TH</sup> %-ILE QUEUE
McEwen Drive and Ramps for I-65 (signalized)	Overall Intersection	LOS C (33 sec/veh)		LOS F (90 sec/veh)	
E. McEwen Drive and Tower Drive (signalized)	Overall Intersection	LOS C (21 sec/veh)		LOS F (160 sec/veh)	
E. McEwen Drive and Carothers Parkway (signalized)	Overall Intersection	LOS F (229 sec/veh)		LOS F (234 sec/veh)	
E. McEwen Drive and Resource Parkway (signalized)	Overall Intersection	LOS B (17 sec/veh)		LOS B (17 sec/veh)	
Carothers Parkway and Tower Circle / Pacific Drive (signalized)	Overall Intersection	LOS C (23 sec/veh)		LOS F (168 sec/veh)	
Carothers Parkway and Resource Parkway (signalized)	Overall Intersection	LOS B (17 sec/veh)		LOS C (28 sec/veh)	
Resource Parkway and Pacific Drive (unsignalized)	Northbound Turning Movements	LOS A	1 veh	LOS A	1 veh
	Southbound Turning Movements	LOS A	1 veh	LOS B	1 veh
	Eastbound Turning Movements	LOS A	1 veh	LOS A	1 veh
	Westbound Turning Movements	LOS A	1 veh	LOS A	1 veh
Resource Parkway and Terrapin Street (unsignalized)	Eastbound Left Turns / Thrus	LOS A	1 veh	LOS A	1 veh
	Southbound Left and Right Turns	LOS A	1 veh	LOS A	1 veh



<b>Resource Parkway and Lemon Grass Drive</b> (traffic circle)	Eastbound Approach	LOS A	1 veh	LOS A	1 veh
	Westbound Approach	LOS A	1 veh	LOS A	1 veh
	Southbound Approach	LOS A	1 veh	LOS A	1 veh

## 5. IMPACTS OF PROPOSED DEVELOPMENT

### 5.1 TRIP GENERATION

Trip generation calculations were conducted in order to identify how much traffic will be generated by the proposed project. Trip generation data for daily and peak hour trips were identified from Trip Generation, Ninth Edition, which was published by the Institute of Transportation Engineers (ITE) in 2012. [Table 6](#) presents the daily and peak hour trip generations for proposed project, and these calculations are included in [Appendix D](#).

**TABLE 6. TRIP GENERATION FOR THE PROPOSED PROJECT**

LAND USE	SIZE	DAILY TRAFFIC	GENERATED TRAFFIC			
			AM PEAK HOUR		PM PEAK HOUR	
			ENTER	EXIT	ENTER	EXIT
Multi-Family (LUC 220)	325 units	2,162	33	133	131	71
Townhomes (LUC 230)	15 homes	124	2	9	9	4
Office (LUC 710)	300,000 sq.ft.	3,026	406	55	70	344
Hotel (LUC 310)	200 rooms	1,784	78	56	69	71
Specialty Retail (LUC 826)	25,000 sq.ft.	2,176	164	178	62	79
<b>TOTAL</b>		<b>9,272</b>	<b>683</b>	<b>431</b>	<b>341</b>	<b>569</b>
<b>TOTAL REDUCED 20% TO ACCOUNT FOR INTERNAL CAPTURE AND TRANSIT USAGE</b>		<b>7,418</b>	<b>546</b>	<b>345</b>	<b>273</b>	<b>455</b>

Studies have shown that, typically, a portion of the trips generated by mixed-use developments are captured, or "pass-by" trips from the adjacent street system. However, for the purposes of this study, it was assumed that none of the peak hour traffic generated by the proposed project will be pass-by traffic.

Also, studies have shown that it is common for a portion of the trips generated by mixed-use developments are internal to the site. For example, a portion of the vehicles generated by one of the residential land uses will shop at one or more of the commercial land uses and/or work in the office space. Therefore, consideration was given to the methodology included in NCHRP Report 684, which is endorsed by the Institute of Transportation Engineers (ITE) for estimating internal capture within mixed-use developments. The worksheets are included in [Appendix D](#), and based on this information, it was assumed that the daily and peak hour traffic volumes can be reduced by 20% to account for internal, shared trips.

## 5.2 TRIP DISTRIBUTION AND TRAFFIC ASSIGNMENT

For the purposes of this study, it was estimated that the trips generated by the proposed project will access the project site according to the directional distribution shown in [Figure 6](#). It is important to note that these directional distributions were prepared with input and approval from the City of Franklin Engineering Department and their third-party private consultant. The development of these distributions was based on the following factors:

- existing land use characteristics,
- the directions of approach of the existing traffic,
- the access proposed for the project, and
- the locations of population centers in the area.

It is important to note that the distribution shown in [Figure 6](#) has been adjusted since a directional distribution was approved by the City of Franklin Engineering Department. These adjustments were made as the site plan was modified.

The peak hour trip generations and directional distribution were used to add the site-generated trips to the roadway system. [Figure 7](#) includes the peak hour traffic volumes that are expected to be generated by the proposed project.



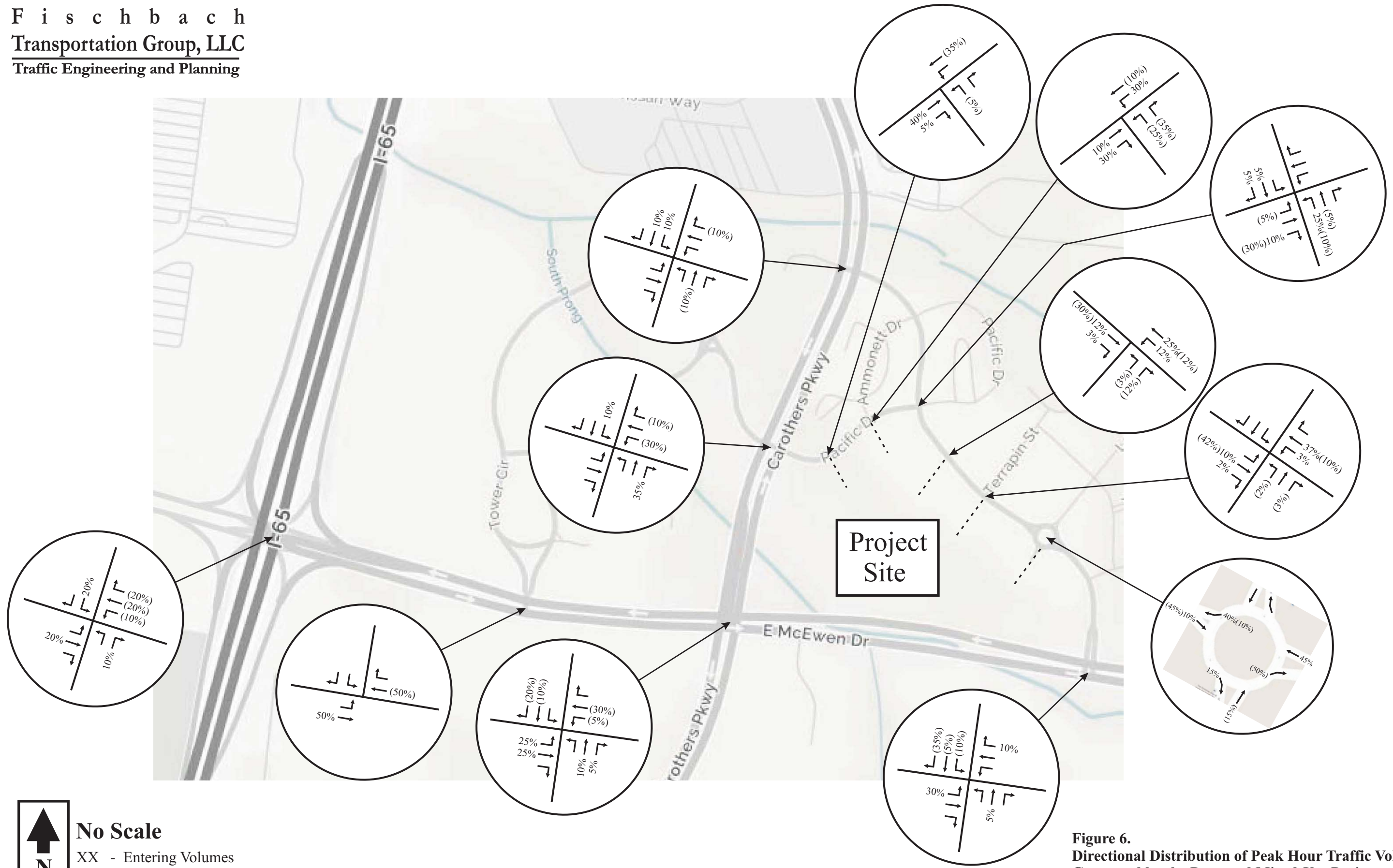

**No Scale**  
 ↑  
 N  
 XX - Entering Volumes  
 (XX) - Exiting Volumes

**Figure 6.**  
 Directional Distribution of Peak Hour Traffic Volumes  
 Generated by the Proposed Mixed-Use Project

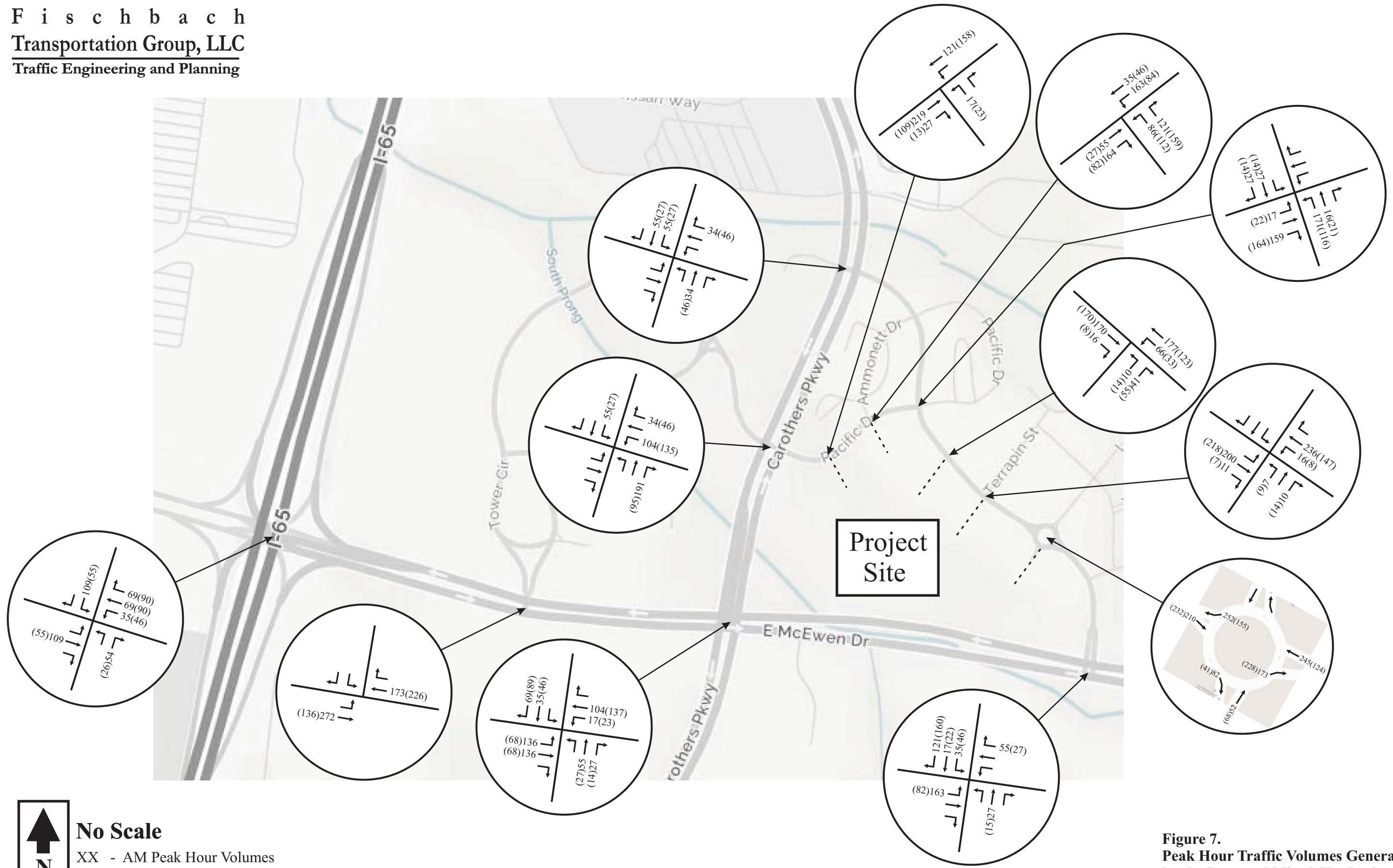

**No Scale**  
 ↑  
 N  
 XX - AM Peak Hour Volumes  
 (XX) - PM Peak Hour Volumes

**Figure 7.**  
**Peak Hour Traffic Volumes Generated**  
**by the Proposed Mixed-Use Project**

### 5.3 CAPACITY ANALYSES

In order to identify the projected peak hour traffic volumes at the completion of the proposed project, the trips generated by the project were added to the background peak hour traffic volumes. The resulting peak hour volumes are shown in [Figure 8](#).

Using the total projected peak hour traffic volumes, capacity analyses were conducted in order to determine the impact of the project on the roadway system. Specifically, these capacity analyses were used to evaluate the need for roadway and traffic control improvements within the study area. For these analyses, it was assumed that all background laneage and traffic control will be maintained and no additional improvements will be provided.

The results of the capacity analyses for the total projected peak hour traffic volumes are shown in [Table 7](#), and [Appendix C](#) includes the capacity analyses worksheets. In particular, the results of the analyses for the signalized intersections within the study area are as follows:

#### **Intersection of E. McEwen Drive and the Ramps for I-65**

This intersection is expected to operate at LOS C during the AM peak hour and LOS F during the PM peak hour. During the AM peak hour, the left turns are expected to operate poorly. During the PM peak hour, several turning movements are expected to operate poorly, and the westbound right turns are expected to have significant queue lengths.

#### **Intersection of E. McEwen Drive and Tower Circle**

This intersection is expected to operate at LOS B during the AM peak hour and LOS F during the PM peak hour. During the AM peak hour, the eastbound and southbound left turns are expected to operate at LOS E. During the PM peak hour, several turning movements are expected to operate poorly, and the westbound throughs are expected to have significant queue lengths.

#### **Intersection of E. McEwen Drive and Carothers Parkway**

This intersection is expected to operate at LOS F during both peak hours. During the AM peak hour, all of the left turns, as well as the northbound throughs, are expected to operate poorly. The eastbound left turns, in particular, will have significant delays and vehicle queues. During the PM peak hour, the southbound through and right turn volumes will be significant, and these queues are expected to affect intersections upstream on Carothers Parkway.

#### **Intersection of McEwen Drive and Resource Parkway**

This intersection is expected to operate at LOS C during both peak hours., and the vehicle delays and queues are expected to remain relatively low.

#### **Intersection of Carothers Parkway and Tower Circle/Pacific Drive**

This intersection is expected to operate at LOS D during the AM peak hour and LOS F during the PM peak hour. During the PM peak hour, the eastbound left turns and the southbound

throughs are expected to have significant queues, and these queues are expected to several intersections upstream on Carothers Parkway.

**Intersection of Carothers Parkway and Resource Parkway**

This intersection is expected to operate at LOS D during the AM peak hour and LOS C during the PM pea hour. During the AM peak hour, the southbound lefts are expected to operate poorly. During the PM peak hour, the southbound throughs are expected to have significant queues, and these queues are expected to affect intersections upstream on Carothers Parkway.



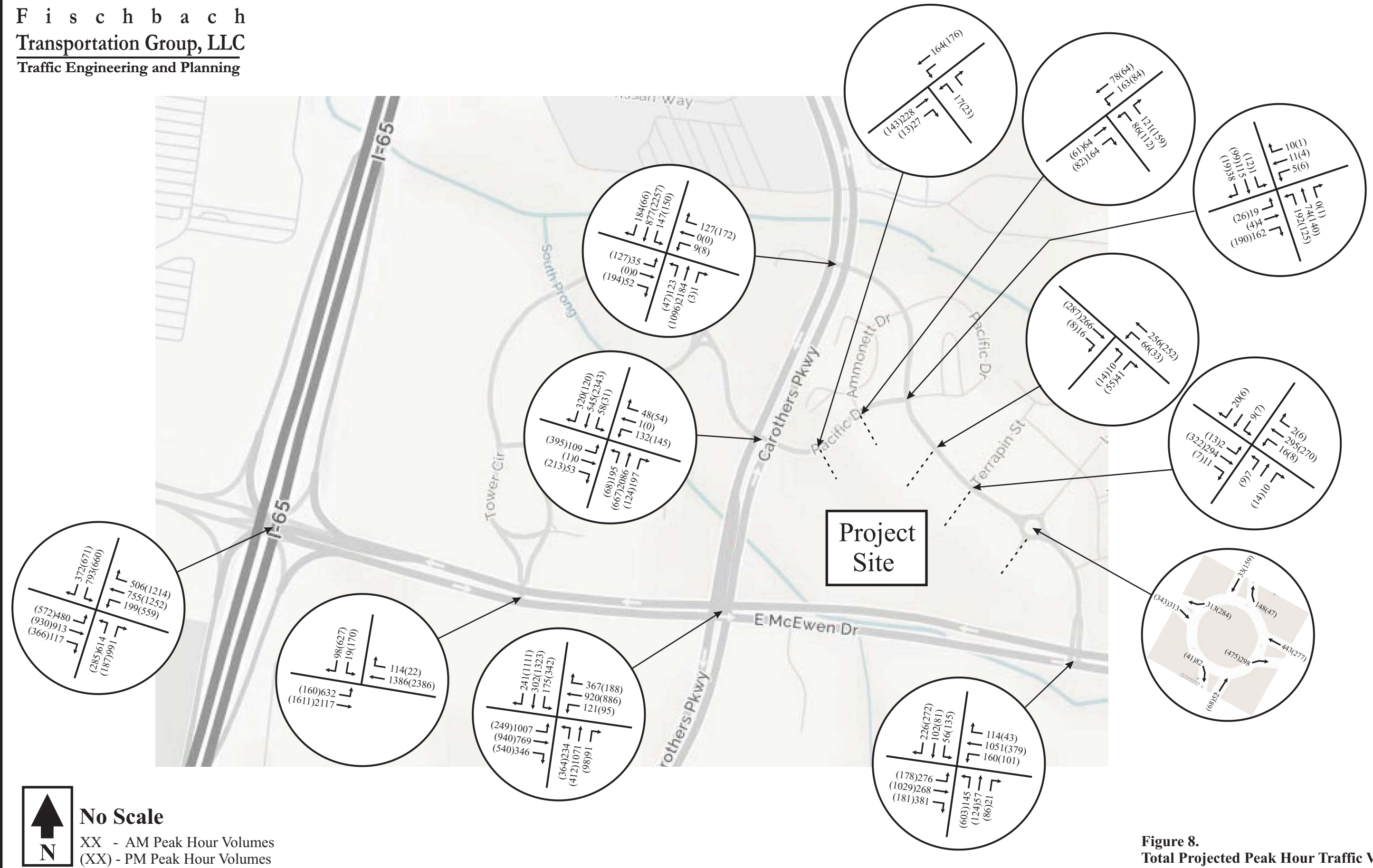

Figure 8.  
 Total Projected Peak Hour Traffic Volumes

**TABLE 7. PROJECTED PEAK HOUR LEVELS OF SERVICE**

INTERSECTION	TURNING MOVEMENT	AM PEAK HOUR		PM PEAK HOUR	
		LEVEL OF SERVICE	95 <sup>TH</sup> %-ILE QUEUE	LEVEL OF SERVICE	95 <sup>TH</sup> %-ILE QUEUE
McEwen Drive and Ramps for I-65 (signalized)	Overall Intersection	LOS C (35 sec/veh)		LOS F (128 sec/veh)	
E. McEwen Drive and Tower Drive (signalized)	Overall Intersection	LOS C (21 sec/veh)		LOS F (270 sec/veh)	
E. McEwen Drive and Carothers Parkway (signalized)	Overall Intersection	LOS F (317 sec/veh)		LOS F (282 sec/veh)	
E. McEwen Drive and Resource Parkway (signalized)	Overall Intersection	LOS C (26 sec/veh)		LOS C (21 sec/veh)	
Carothers Parkway and Tower Circle / Pacific Drive (signalized)	Overall Intersection	LOS D (55 sec/veh)		LOS F (259 sec/veh)	
Carothers Parkway and Resource Parkway (signalized)	Overall Intersection	LOS D (42 sec/veh)		LOS C (30 sec/veh)	
Resource Parkway and Pacific Drive (unsignalized)	Northbound Turning Movements	LOS A	1 veh	LOS A	1 veh
	Southbound Turning Movements	LOS A	1 veh	LOS A	1 veh
	Eastbound Turning Movements	LOS B	1 veh	LOS B	1 veh
	Westbound Turning Movements	LOS B	1 veh	LOS C	1 veh
Resource Parkway and Terrapin Street / Project Access (unsignalized)	Northbound Turning Movements	LOS A	1 veh	LOS A	1 veh
	Southbound Turning Movements	LOS A	1 veh	LOS A	1 veh
	Eastbound	LOS B	1 veh	LOS B	1 veh

	Turning Movements				
	Westbound Turning Movements	LOS B	1 veh	LOS B	1 veh
<b>Resource Parkway and Lemon Grass Drive</b> (traffic circle)	Eastbound Approach	LOS A	1 veh	LOS A	2 veh
	Westbound Approach	LOS A	2 veh	LOS A	1 veh
	Northbound Approach	LOS A	1 veh	LOS A	1 veh
	Southbound Approach	LOS A	1 veh	LOS A	1 veh
<b>Pacific Drive and the Western Project Drive</b>	Westbound Left Turns/Thrus	LOS A	0 veh	LOS A	0 veh
	Northbound Left and Right Turns	LOS B	1 veh	LOS B	1 veh
<b>Pacific Drive and the Garage Drive</b>	Westbound Left Turns	LOS A	1 veh	LOS A	1 veh
	Northbound Left Turns	LOS C	1 veh	LOS B	1 veh
	Northbound Right Turns	LOS B	1 veh	LOS A	1 veh
<b>Resource Parkway and Northern Project Access</b>	Northbound Left Turns/Thrus	LOS A	1 veh	LOS A	1 veh
	Eastbound Left and Right Turns	LOS B	1 veh	LOS B	1 veh

## 5.4 CAPACITY ANALYSIS COMPARISON

The results of the capacity analyses for the existing, background, and total projected peak hour traffic volumes are included in [Tables 8 and 9](#) for comparison purposes.

**TABLE 8. COMPARISON OF AM PEAK HOUR LEVELS OF SERVICE**

INTERSECTION	TURNING MOVEMENT	LEVELS OF SERVICE		
		EXISTING CONDITIONS	BACKGROUND CONDITIONS	TOTAL PROJECTED CONDITIONS
McEwen Drive and the Ramps for I-65	Overall Intersection	LOS C (35 sec/veh)	LOS C (35 sec/veh)	LOS C (35 sec/veh)
E. McEwen Drive and Tower Circle	Overall Intersection	LOS B (14 sec/veh)	LOS C (21 sec/veh)	LOS C (21 sec/veh)
E. McEwen Drive and Carothers Parkway	Overall Intersection	LOS F (96 sec/veh)	LOS F (229 sec/veh)	LOS F (317 sec/veh)
E. McEwen Drive and Resource Parkway	Overall Intersection	(unsignalized)	LOS B (17 sec/veh)	LOS C (26 sec/veh)
Carothers Parkway and Tower Circle / Pacific Drive	Overall Intersection	LOS B (12 sec/veh)	LOS C (23 sec/veh)	LOS D (55 sec/veh)
Carothers Parkway and Resource Parkway	Overall Intersection	(unsignalized)	LOS B (17 sec/veh)	LOS D (42 sec/veh)

**TABLE 9. COMPARISON OF PM PEAK HOUR LEVELS OF SERVICE**

INTERSECTION	TURNING MOVEMENT	LEVELS OF SERVICE		
		EXISTING CONDITIONS	BACKGROUND CONDITIONS	TOTAL PROJECTED CONDITIONS
McEwen Drive and the Ramps for I-65	Overall Intersection	LOS C (24 sec/veh)	LOS F (90 sec/veh)	LOS F (128 sec/veh)
E. McEwen Drive and Tower Circle	Overall Intersection	LOS B (14 sec/veh)	LOS F (160 sec/veh)	LOS F (270 sec/veh)
E. McEwen Drive and Carothers Parkway	Overall Intersection	LOS C (35 sec/veh)	LOS F (234 sec/veh)	LOS F (282 sec/veh)
E. McEwen Drive and Resource Parkway	Overall Intersection	(unsignalized)	LOS B (17 sec/veh)	LOS C (21 sec/veh)
Carothers Parkway and Tower Circle / Pacific Drive	Overall Intersection	LOS B (14 sec/veh)	LOS F (168 sec/veh)	LOS F (259 sec/veh)
Carothers Parkway and Resource Parkway	Overall Intersection	(unsignalized)	LOS C (28 sec/veh)	LOS C (30 sec/veh)

## 6. CONCLUSIONS AND RECOMMENDATIONS

It is important to note that the City of Franklin's existing zoning for the proposed project site allows all of the proposed land uses on the project site, with the exception of the apartments. The analyses presented in this study indicate that the following improvements and considerations should be incorporated into the current site plan in order to facilitate safe and efficient traffic operations within the study area:

1. As planned under background conditions with the construction of the Ovation mixed-use project, a traffic signal should be installed at the intersection of E. McEwen Drive and Resource Parkway.
2. As planned under background conditions, a traffic signal should be installed at the intersection of Carothers Parkway and Resource Parkway.
3. Each of the driveways for the structure parking should include one entering lane and two exiting lanes striped as separate left and right turn lanes.
4. Each of the driveways to surface parking should include one entering lane and one exiting lane, striped as a shared left and right turn lane.

It is important to note that the capacity analyses conducted for the purposes of this study indicate that the peak hour traffic volumes that are expected to be generated by the projects that have been approved for construction nearest the proposed project site will exceed the capacity of the existing intersections and roadway segments within the study area. Specifically, the Ovation and Franklin Park projects will add a total of 2,400,000 sq.ft of office space, 357,500 sq.ft. of retail space, a 300-room hotel, and 1,300 apartments to the study area. The traffic volumes generated by these land uses will exceed the capacity of the existing laneage and traffic control within the study area.

In October 2012, Kimley-Horn and Associates, Inc. prepared an Integrated Growth Plan for the City of Franklin to address the anticipated growth in the study area and identify future infrastructure improvements that will be needed to accommodate future traffic volumes. The Integrated Growth Plan assumed that the proposed project site would include 253 apartments and 300,000 sq.ft. of office space. These assumptions account for the majority of the peak hour traffic volumes that will be generated by the current proposal, and it is appropriate to assume that the recommendations included in the Integrated Growth Plan adequately account for the impacts of the proposed plan. Therefore, in conjunction with the proposed project, adequate right-of-way should be dedicated on the east side of Carothers Parkway and the north side of E. McEwen Drive to accommodate the City's future expansion of these facilities. Also, the Road Impact Fees generated by the proposed land uses should be aggregated with those collected by the other approved projects and applied to the future laneage and traffic control needs within the study area.



**APPENDIX A  
TRAFFIC IMPACT STUDY SCOPE PROVIDED BY  
THE CITY OF FRANKLIN AND VOLKERT, INC.**

**REVIEWED**

By Carl Baughman at 12:10 pm, Jun 21, 2016

Exhibit B

City of Franklin  
Engineering Department  
**APPLICATION FORM**  
**REQUEST FOR APPROVED TRANSPORTATION IMPACT ANALYSIS**  
**REPORT**

Applicant Name:	<b>Pearl Street Partners, LLC</b>	Applicant Name:	<b>FTG, LLC</b>
Address:	<b>205 Powell Place</b>	Address:	<b>PO Box 682736</b>
	<b>Brentwood, TN 37027</b>		<b>Franklin, TN 37068</b>
Phone #:	<b>(615) 312-8242</b>	Phone #:	<b>(615) 771-8022</b>
e-mail address:	<b>byoeckel@pearlstreetpartners.com</b>	e-mail address:	<b>Gillian@FTGtraffic.com</b>

### **PROCESS OVERVIEW**

A Transportation Impact Analysis shall be prepared by the Applicant's Consultant or the City's Traffic Consultant using the standard format specified by the Institute of Transportation Engineers in accordance with the following:

- (i) The applicant shall submit a completed *Request for Transportation Impact Analysis Application Form* to the Engineering Department.
- (ii) Scope of Services
  - a. Following initial review of the application form, the Engineering Department shall prepare and submit a Scope of Services and schedule to the Applicant. If necessary a meeting will be scheduled to review and discuss the Scope of Services in detail.
  - b. Following approval the applicant will pay the City 90% of the estimated cost of the traffic impact study. At the completion of the study the City shall reimburse the applicant all remaining fees.
- (iii) Transportation impact analyses shall be prepared utilizing traffic data that are consistent with:
  - a. The land use and density data as referenced in the most current edition of Trip Generation, published by the Institute of Transportation Engineers;
  - b. Current city and state traffic counts for surrounding streets;
  - c. Any additional traffic counts performed as a part of preparing the study.

### **Attachment A**

City of Franklin Review Process for Transportation Impact Analysis

**Step 1 – Preliminary discussion with Consultant/Developer on project description including site plan.**

**Step 2 – Scoping of Transportation Impact Analysis between the City of Franklin and Consultant/Developer.**

**Step 3 – Consultant, Traffic Engineer and Director of Engineering execute a MOU (Fees may apply per COF Ordinance 2015-64.**

**Step 4 – Consultant/Developer pays review fee and submits Transportation Impact Analysis.**

- Step 5 – City of Franklin prepares initial comments on the transportation impact analysis, if necessary.**
- Step 6 – Consultant submits corrections/revisions to the transportation impact analysis, if necessary.**
- Step 7 – City of Franklin prepares initial comments on proposed mitigation measures, if necessary**
- Step 8 – Consultant submits corrections/revisions on proposed mitigation measures, if necessary and electronic copy of the transportation impact analysis.**
- Step 9 – City of Franklin issues an assessment letter**

## Attachment B

### Transportation Impact Analysis – Memorandum of Understanding (MOU)

This MOU acknowledges that the transportation impact analysis for the following project will be prepared in accordance with the latest version of City of Franklin Zoning Ordinance.

Project Name: **Village on the Hill (Crescent Resource Centre)**  
 Project Address: **Northeast quadrant of Carothers Parkway and McEwen Drive**  
 Project Description: **mixed-use (see attached)**

Attach a site map and a trip generation table with a description of the proposed land uses, ITE rates, estimated daily, morning, midday and afternoon peak hour volumes (ins/outs/totals), proposed trip credits, etc.

Project Buildout Year: **2022** Ambient or CMP Growth Rate: **Background traffic to be discussed with the City of Franklin Engineering Department**

Study Intersections:

1. <b>E. McEwen Drive and Tower Circle</b> (signalized)	7. <b>Resource Parkway and Lemon Grass Drive / Project Access</b> (unsignalized)
2. <b>Carothers Parkway and E. McEwen Drive</b> (signalized)	8. <b>E. McEwen Drive and Resource Parkway</b> (unsignalized)
3. <b>Carothers Parkway and Tower Circle / Pacific Drive</b> (signalized)	9. <b>Pacific Drive and project access</b> (unsignalized)
4. <b>Carothers Parkway and Resource Parkway</b> (unsignalized)	10. <b>McEwen Drive &amp; I-65 (signalized &amp; unsignalized)</b>
5. <b>Resource Parkway and Pacific Drive</b> (unsignalized)	11.
6. <b>Resource Parkway and Terrapin Street / Project Access</b> (unsignalized)	12.

Trip Credits: (Exact amount of credit subject to approval by City of Franklin)

	Yes	No
Transit Usage		<b>X</b>
Existing Active Land Use		<b>X</b>
Previous Land Use		<b>X</b>
Internal Trip	<b>X</b>	
Pass-By Trip	<b>X</b>	

Consultant  
Name: **FTG, LLC**  
Address: **PO Box 682736; Franklin, TN**  
Phone No: **(615) 771-8022**  
Email: **Gillian@FTGtraffic.com**  
Approved By: \_\_\_\_\_  
City of Franklin Traffic Engineer

Developer  
**Pearl Street Partners, LLC**  
**205 Powell Place; Brentwood, TN**  
**(615) 312-8242**  
**byoeckel@pearlstreetpartners.com**  
\_\_\_\_\_  
Director of Engineering

**Reason for Request:** (Planned Unit Development, Site Plan, Rezoning)  
**Concept Plan**

---

**Description of Proposed Project** (Address, Map/Parcel Number, etc.) (Attach a conceptual development plans showing all access points and adjacent streets.):  
**Northeast quadrant of Carothers Parkway and McEwen Drive**

---

**Existing Land Use** (be specific):  
**N/A**

---

**Proposed Land Use** (be specific):  
**Mixed-use (see attached)**

---

**Potential Development Yield** (number of residential units; building square footage, projected number of employees, hours of operations):  
**Mixed-use (see attached)**

---

**As applicant, I agree to pay to the City of Franklin 90% of the entire cost of the Transportation Impact Analysis.**

Property Owner Signature: \_\_\_\_\_

Property Owner Title: \_\_\_\_\_

Date: \_\_\_\_\_

The information above shall be submitted to the Engineering Department (109 3<sup>rd</sup> Ave South; Franklin, TN 37064) to review and provide estimated cost along with a proposed scope of services. All questions should be directed to Carl Baughman, Traffic Engineer III (615-791-3218).



**APPENDIX B  
EXISTING TRAFFIC COUNTS**

INTERSECTION TRAFFIC VOLUME COUNTS

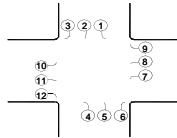

LOCATION: McEwen Drive and the Ramps for I-65  
 DATE: November 2015  
 RECORDER: Burns  
 NOTES: signalized

LOCATION	S/B Ramps from SB I-65			N/B Ramps from NB I-65			W/B McEwen Drive			E/B McEwen Drive			Hourly Total	15-min Total
TIME	1	2	3	4	5	6	7	8	9	10	11	12		
6:30-6:45	37		73	63		63	25	61	63	122	27	19	3,012	553
6:45-7:00	45		72	104		50	15	75	91	174	47	28	3,412	701
7:00-7:15	72		103	109		82	25	112	98	124	64	28	3,671	817
7:15-7:30	74		85	148		111	33	133	108	152	59	38	3,754	941
7:30-7:45	91		95	185		136	28	111	82	112	94	19	3,588	953
7:45-8:00	127		88	149		123	23	134	66	121	91	38	3,354	960
8:00-8:15	108		104	132		115	41	133	73	95	77	22	3,156	900
8:15-8:30	90		84	115		90	15	102	60	117	65	37	2,820	775
8:30-8:45	53		85	107		93	30	109	51	99	65	27	2,579	719
8:45-9:00	66		109	130		66	19	101	51	131	60	29	2,338	762
9:00-9:15	35		69	96		43	24	72	37	101	50	37	2,073	564
9:15-9:30	42		82	80		40	20	73	26	90	43	38		534
9:30-9:45	34		88	77		24	11	54	27	78	47	38		478
9:45-10:00	45		90	75		19	12	55	27	99	37	38		497
10:00-10:15														
10:15-10:30														
10:30-10:45	26		88	62		16	14	63	28	84	34	52	2,210	467
10:45-11:00	23		95	83		19	16	77	34	71	49	44	2,501	511
11:00-11:15	31		100	64		16	29	107	33	99	53	44	2,741	576
11:15-11:30	33		110	82		25	27	134	48	73	56	68	2,998	656
11:30-11:45	41		140	71		19	34	176	46	81	83	67	3,143	758
11:45-12:00	31		117	73		28	33	161	36	94	102	76	3,167	751
12:00-12:15	37		139	67		21	44	166	43	112	131	73	3,201	833
12:15-12:30	38		120	70		22	20	123	46	127	139	96		801
12:30-12:45	61		136	60		22	24	110	32	106	134	97		782
12:45-1:00	52		109	61		26	15	97	39	121	163	102		785
1:00-1:15														
1:15-1:30														
1:30-1:45														
1:45-2:00														
2:00-2:15	55		102	48		13	22	60	34	94	67	119	2,622	614
2:15-2:30	32		106	46		12	28	66	34	101	97	103	2,701	625
2:30-2:45	44		93	58		15	43	47	35	94	90	144	2,787	663
2:45-3:00	54		125	42		18	41	67	47	115	89	122	2,878	720
3:00-3:15	47		123	64		9	47	52	69	96	78	108	2,903	693
3:15-3:30	63		120	54		16	30	86	37	112	89	104	3,251	711
3:30-3:45	65		113	63		27	52	73	52	115	89	105	3,440	754
3:45-4:00	50		126	41		25	49	81	70	114	89	100	3,772	745
4:00-4:15	76		125	73		20	92	108	120	153	141	133	4,119	1,041
4:15-4:30	113		141	54		29	54	78	89	105	143	94	4,246	900
4:30-4:45	132		156	66		22	51	122	143	163	132	99	4,522	1,086
4:45-5:00	116		155	77		16	63	132	157	135	153	88	4,521	1,092
5:00-5:15	113		175	71		14	94	133	181	129	161	97	4,420	1,168
5:15-5:30	101		185	71		23	92	177	142	145	158	82	4,094	1,176
5:30-5:45	113		180	68		20	96	139	105	114	162	88	3,623	1,085
5:45-6:00	117		170	55		29	39	99	71	162	173	76		991
6:00-6:15	101		150	50		17	46	105	41	136	107	89		842
6:15-6:30	60		146	43		11	39	67	40	104	83	112		705
<b>TOTAL</b>	<b>2,744</b>		<b>4,872</b>	<b>3,307</b>		<b>1,605</b>	<b>1,555</b>	<b>4,231</b>	<b>2,712</b>	<b>4,770</b>	<b>3,871</b>	<b>3,018</b>		
<b>AM PK HR</b>	400		372	614		485	125	511	329	480	321	117	7:15-8:15	
<b>MID PK HR</b>	188		504	258		91	103	496	160	466	567	368	12:00-1:00	
<b>PM PK HR</b>	462		671	285		75	300	564	623	572	604	366	4:30-5:30	
<b>AM PK PHF</b>	0.79		0.89	0.83		0.89	0.76	0.95	0.76	0.79	0.85	0.77	0.98	IS PHF (AM)
<b>MID PK PHF</b>	0.77		0.91	0.92		0.88	0.59	0.75	0.87	0.92	0.87	0.90	0.96	IS PHF (MID)
<b>PM PK PHF</b>	0.88		0.91	0.93		0.82	0.80	0.80	0.86	0.88	0.94	0.92	0.96	IS PHF (PM)

AM PEAK

LOCATION: Mc Ewen & Tower  
 DATE: 5-Apr-16  
 TIME OF DAY: AM

ANALYST: HGB

			337						NORTH/SOUTH STREET: Tower					
			TOTAL						NB EXIT					
			88% 0% 13%						321					
			SBRT SB SBLT						EBLT NB WBRT			EAST/WEST STREET: Mc Ewen		
14 0 2			268 0 53											
WB EXIT 989			SBRT 14			53 WBRT 5%			975 WB 95% 1028 WB ENTER					
			WB 975			975 WB 95% 1028 WB ENTER								
			NBLT 0			0 WBRT 0%								
2247 TOTAL									TOTAL 2020					
21% EBLT 268						2 SBLT								
EB ENTER 1258 79% EB 990						990 EB			992 EB EXIT					
0% EBRT 0						0 NBRT								
			0 0 0			0 0 0								
			EBRT SB WBLT			NBLT NB NBRT								
						#DIV/0! #DIV/0! #DIV/0!								
			0			0								
SB EXIT			TOTAL			NB ENTER								
			0											

PM PEAK

LOCATION: Mc Ewen & Tower  
 DATE: 7-Apr-16  
 TIME OF DAY: PM

ANALYST: HGB

			441						NORTH/SOUTH STREET: Tower					
			TOTAL									NB EXIT		
			74% 0% 26%									27		
			SBRT SB SBLT									EBLT NB WBRT		
308 0 106			27 0 0			EAST/WEST STREET: Mc Ewen								
WB EXIT 1775			SBRT 308			0 WBRT 0%			1467 WB 100% 1467 WB ENTER					
			WB 1467			1467 WB 100% 1467 WB ENTER								
			NBLT 0			0 WBRT 0%								
2910 TOTAL									TOTAL 2681					
EB ENTER 1135			2% EBLT 27			106 SBLT			1108 EB 1108					
			98% EB 1108			1108 EB			1214 EB EXIT					
			0% EBRT 0			0 NBRT								
			0 0 0			0 0 0								
			EBRT SB WBLT			NBLT NB NBRT								
			0			#DIV/0! #DIV/0! #DIV/0!								
			SB EXIT			0 NB ENTER								
			TOTAL											
			0											



INTERSECTION TRAFFIC VOLUME COUNTS

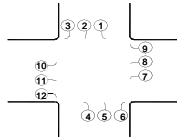

LOCATION: McEwen Drive and Carothers Parkway  
 DATE: 20-Oct-15  
 RECORDER: City of Franklin  
 NOTES: signalized

LOCATION TIME	S/B Carothers Parkway			N/B Carothers Parkway			W/B McEwen Drive			E/B McEwen Drive			Hourly Total	15-min Total
	1	2	3	4	5	6	7	8	9	10	11	12		
6:30-6:45		20	11	9	100	7	11	104	21	47	17	30	2,240	377
6:45-7:00		20	20	31	147	12	10	130	29	73	25	16	2,669	513
7:00-7:15		18	10	43	156	5	16	175	43	80	27	25	3,084	598
7:15-7:30		17	21	59	226	8	23	191	52	108	31	16	3,312	752
7:30-7:45		23	35	45	239	16	26	161	69	123	42	27	3,335	806
7:45-8:00	2	28	31	47	288	12	27	188	72	162	47	24	3,153	928
8:00-8:15	2	16	17	50	205	13	26	158	64	175	56	44	2,841	826
8:15-8:30	3	31	19	29	171	14	24	143	63	208	48	22	2,461	775
8:30-8:45		29	23	31	133	8	24	135	51	128	33	29	2,093	624
8:45-9:00	3	35	23	32	133	14	16	130	28	130	49	23	1,818	616
9:00-9:15	2	36	20	19	89	11	17	77	19	93	38	25	1,519	446
9:15-9:30	1	40	24	27	77	9	23	62	17	63	45	19	1,405	407
9:30-9:45	2	46	21	15	50	11	14	73	12	39	33	33	1,288	349
9:45-10:00	4	26	15	18	65	7	17	58	7	43	35	22	1,262	317
10:00-10:15	5	41	14	25	59	13	13	53	5	23	47	34	1,307	332
10:15-10:30	4	34	28	16	52	5	13	49	7	19	32	31	1,424	290
10:30-10:45	5	42	32	26	60	12	10	48	6	24	45	13	1,571	323
10:45-11:00	3	40	49	22	66	10	12	66	5	32	36	21	1,772	362
11:00-11:15	9	72	93	27	63	9	16	50	5	29	43	33	1,983	449
11:15-11:30	11	50	109	30	56	9	15	61	4	21	50	21	2,097	437
11:30-11:45	14	65	151	35	60	12	15	53	7	42	49	21	2,157	524
11:45-12:00	20	96	135	25	60	16	13	63	5	53	58	29	2,220	573
12:00-12:15	15	96	127	22	56	12	10	58	18	65	62	22	2,196	563
12:15-12:30	8	85	82	21	71	13	9	53	12	71	61	11	2,118	497
12:30-12:45	8	78	94	29	78	11	8	64	30	99	53	35	2,087	587
12:45-1:00	4	61	67	21	99	8	15	56	19	114	55	30	1,939	549
1:00-1:15	5	70	66	12	67	10	10	45	9	98	62	31	1,770	485
1:15-1:30	3	58	47	10	80	10	20	52	9	81	63	33	1,703	466
1:30-1:45	7	58	48	22	50	17	16	52	9	71	56	33	1,640	439
1:45-2:00	6	62	34	10	52	11	18	50	1	56	43	37	1,622	380
2:00-2:15	9	62	37	25	60	9	7	40	4	44	81	40	1,688	418
2:15-2:30	6	44	39	22	54	13	9	60	6	30	86	34	1,806	403
2:30-2:45	5	54	47	30	47	16	20	58	1	34	82	27	1,970	421
2:45-3:00	7	81	45	30	61	14	15	50	1	28	78	36	2,143	446
3:00-3:15	9	85	69	40	50	19	18	62		31	99	54	2,298	536
3:15-3:30	15	85	62	32	42	18	18	54		97	104	40	2,625	567
3:30-3:45	13	123	86	18	49	18	17	68		64	100	38	2,759	594
3:45-4:00	11	150	73	21	65	18	23	63		19	109	49	3,137	601
4:00-4:15	39	267	206	27	47	33	14	52	3	21	101	53	3,463	863
4:15-4:30	22	202	140	17	32	22	22	48	4	19	114	59	3,683	701
4:30-4:45	52	338	182	22	52	17	8	60	3	23	126	89	3,946	972
4:45-5:00	51	241	165	27	41	12	26	90	1	37	139	97	3,841	927
5:00-5:15	57	297	242	18	40	33	17	71		29	160	119	3,684	1,083
5:15-5:30	47	258	160	27	39	20	13	56	1	22	195	126	3,267	964
5:30-5:45	37	213	139	17	31	12	15	75		23	171	134	2,892	867
5:45-6:00	40	147	110	17	35	17	21	53	1	24	205	100		770
6:00-6:15	38	148	103	11	33	16	14	74	8	19	123	79		666
6:15-6:30	22	117	66	15	34	13	13	72	3	15	148	71		589
<b>TOTAL</b>	<b>626</b>	<b>4,305</b>	<b>3,437</b>	<b>1,224</b>	<b>3,920</b>	<b>645</b>	<b>777</b>	<b>3,764</b>	<b>734</b>	<b>2,949</b>	<b>3,562</b>	<b>2,035</b>		
<b>AM PK HR</b>	<b>7</b>	<b>98</b>	<b>102</b>	<b>171</b>	<b>903</b>	<b>55</b>	<b>103</b>	<b>650</b>	<b>268</b>	<b>668</b>	<b>193</b>	<b>117</b>	<b>7,308:30</b>	
<b>MID PK HR</b>	<b>51</b>	<b>355</b>	<b>438</b>	<b>97</b>	<b>265</b>	<b>52</b>	<b>40</b>	<b>238</b>	<b>65</b>	<b>288</b>	<b>234</b>	<b>97</b>	<b>11:45-12:45</b>	
<b>PM PK HR</b>	<b>207</b>	<b>1,134</b>	<b>749</b>	<b>94</b>	<b>172</b>	<b>82</b>	<b>64</b>	<b>277</b>	<b>5</b>	<b>111</b>	<b>620</b>	<b>431</b>	<b>4:30-5:30</b>	

<b>AM PK PHF</b>	0.58	0.79	0.73	0.86	0.78	0.86	0.95	0.86	0.93	0.80	0.86	0.66	<b>0.90</b>	<b>IS PHF (AM)</b>
<b>MID PK PHF</b>	0.64	0.92	0.81	0.84	0.85	0.81	0.77	0.93	0.54	0.73	0.94	0.69	<b>0.95</b>	<b>IS PHF (MID)</b>
<b>PM PK PHF</b>	0.91	0.84	0.77	0.87	0.83	0.62	0.62	0.77	0.42	0.75	0.79	0.86	<b>0.91</b>	<b>IS PHF (PM)</b>

INTERSECTION TRAFFIC VOLUME COUNTS

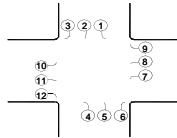

LOCATION: Carothers Parkway and Tower Circle/Pacific Drive  
 DATE: 28-Oct-15  
 RECORDER: City of Franklin  
 NOTES: signalized

LOCATION TIME	S/B Carothers Parkway			N/B Carothers Parkway			W/B Pacific Drive			E/B Tower Circle			Hourly Total	15-min Total
	1	2	3	4	5	6	7	8	9	10	11	12		
6:30-6:45	0	24	4	4	181	1	4	0	3	0	0	1	1,333	222
6:45-7:00	0	18	4	7	239	0	3	0	2	1	0	3	1,615	277
7:00-7:15	0	35	4	1	318	2	5	1	4	2	1	2	1,963	375
7:15-7:30	1	32	4	4	403	1	9	0	4	1	0	0	2,136	459
7:30-7:45	0	48	3	3	434	3	8	0	3	1	0	1	2,072	504
7:45-8:00	1	55	9	2	544	0	7	1	4	2	0	0	1,908	625
8:00-8:15	1	54	1	4	473	2	4	0	3	4	0	2	1,584	548
8:15-8:30	0	35	8	2	337	3	3	1	2	4	0	0	1,270	395
8:30-8:45	0	38	4	3	283	4	2	0	1	4	0	1	1,071	340
8:45-9:00	1	61	2	1	224	3	3	0	2	2	1	1	898	301
9:00-9:15	0	55	7	8	156	2	1	0	1	4	0	0	753	234
9:15-9:30	0	55	2	2	127	2	2	0	1	5	0	0	696	196
9:30-9:45	1	55	5	1	99	1	1	0	1	3	0	0	666	167
9:45-10:00	2	48	3	1	97	1	1	0	2	0	0	1	642	156
10:00-10:15	0	91	2	1	75	2	1	0	0	0	2	3	699	177
10:15-10:30	0	71	8	1	80	0	2	0	0	3	0	1	827	166
10:30-10:45	0	68	0	1	71	0	0	0	1	2	0	0	959	143
10:45-11:00	0	112	1	1	91	5	0	0	0	1	0	2	1,149	213
11:00-11:15	0	208	1	0	80	1	1	0	4	7	0	3	1,286	305
11:15-11:30	1	184	2	1	94	0	3	0	0	11	0	2	1,371	298
11:30-11:45	0	209	5	2	102	2	0	0	2	8	0	3	1,444	333
11:45-12:00	0	215	5	1	114	4	3	0	1	3	1	3	1,467	350
12:00-12:15	3	193	5	6	168	3	3	0	0	5	0	4	1,444	390
12:15-12:30	0	169	9	3	174	5	2	0	1	3	1	4	1,388	371
12:30-12:45	1	142	7	0	193	3	1	0	1	5	1	2	1,253	356
12:45-1:00	2	127	6	3	177	2	4	0	2	2	0	2	1,137	327
1:00-1:15	1	149	9	3	154	7	3	0	1	5	0	2	1,032	334
1:15-1:30	2	120	3	0	101	1	4	1	2	1	1	0	920	236
1:30-1:45	1	96	2	0	126	3	5	0	4	2	0	1	866	240
1:45-2:00	0	113	1	0	101	0	2	1	0	2	0	2	845	222
2:00-2:15	1	114	4	2	91	3	0	0	1	3	0	3	873	222
2:15-2:30	1	86	1	1	87	2	0	0	0	3	1	0	876	182
2:30-2:45	1	131	1	0	78	3	2	0	1	1	0	1	949	219
2:45-3:00	1	138	2	1	96	2	4	0	1	0	0	5	1,035	250
3:00-3:15	2	149	1	1	68	0	0	0	1	1	0	2	1,108	225
3:15-3:30	0	157	3	1	84	2	0	0	1	2	0	5	1,442	255
3:30-3:45	3	218	3	1	71	0	3	0	1	1	0	4	1,710	305
3:45-4:00	0	249	3	0	56	4	3	0	3	2	0	3	1,976	323
4:00-4:15	5	474	2	1	59	7	5	0	2	1	0	3	2,195	559
4:15-4:30	2	430	1	2	71	5	3	0	3	2	0	4	2,335	523
4:30-4:45	1	474	1	0	77	4	1	0	1	5	0	7	2,342	571
4:45-5:00	1	467	2	0	57	7	1	0	1	2	0	4	2,229	542
5:00-5:15	1	600	3	1	70	8	3	0	0	4	1	8	2,032	699
5:15-5:30	1	443	3	1	63	10	1	0	3	2	0	3	1,644	530
5:30-5:45	3	367	3	1	60	12	2	0	2	5	1	2	1,328	458
5:45-6:00	3	261	1	1	66	4	1	0	1	5	0	2	345	345
6:00-6:15	0	266	2	0	30	3	0	0	3	6	0	1	311	311
6:15-6:30	0	144	4	1	47	10	4	0	1	1	0	2	214	214
<b>TOTAL</b>	<b>44</b>	<b>8,048</b>	<b>166</b>	<b>81</b>	<b>7,047</b>	<b>149</b>	<b>120</b>	<b>5</b>	<b>78</b>	<b>139</b>	<b>11</b>	<b>105</b>		
<b>AM PK HR</b>	<b>3</b>	<b>189</b>	<b>17</b>	<b>13</b>	<b>1,854</b>	<b>6</b>	<b>28</b>	<b>1</b>	<b>14</b>	<b>8</b>	<b>0</b>	<b>3</b>	<b>7:15-8:15</b>	
<b>MID PK HR</b>	<b>4</b>	<b>719</b>	<b>26</b>	<b>10</b>	<b>649</b>	<b>15</b>	<b>9</b>	<b>0</b>	<b>3</b>	<b>16</b>	<b>3</b>	<b>13</b>	<b>11:45-12:45</b>	
<b>PM PK HR</b>	<b>4</b>	<b>1,984</b>	<b>9</b>	<b>2</b>	<b>2,67</b>	<b>29</b>	<b>6</b>	<b>0</b>	<b>5</b>	<b>13</b>	<b>1</b>	<b>22</b>	<b>4:30-5:30</b>	

AM PK PHF	0.75	0.86	0.47	0.81	0.85	0.50	0.78	0.25	0.88	0.50		0.38	0.85	IS PHF (AM)
MID PK PHF	0.33	0.84	0.72	0.42	0.84	0.75	0.75		0.75	0.80	0.75	0.81	0.94	IS PHF (MID)
PM PK PHF	1.00	0.83	0.75	0.50	0.87	0.73	0.50		0.42	0.65	0.25	0.69	0.84	IS PHF (PM)

**LOCATION:** Carothers Pkwy -- Resource Pkwy  
**CITY/STATE:** Franklin , TN

**QC JOB #:** 13867213  
**DATE:** Thu, Aug 11 2016

**Peak-Hour: 7:30 AM -- 8:30 AM**  
**Peak 15-Min: 7:45 AM -- 8:00 AM**

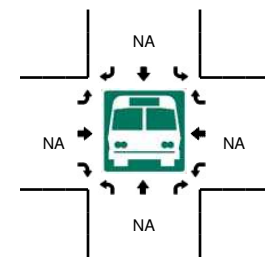
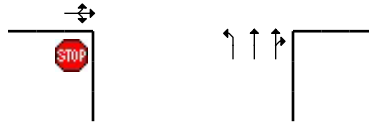
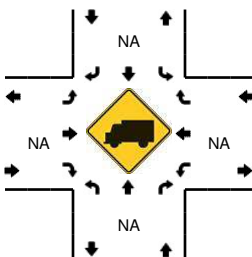
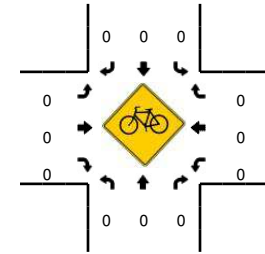
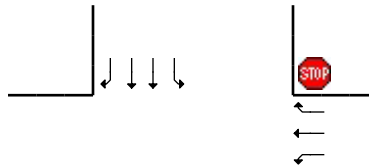
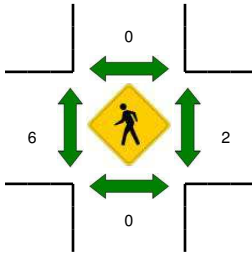
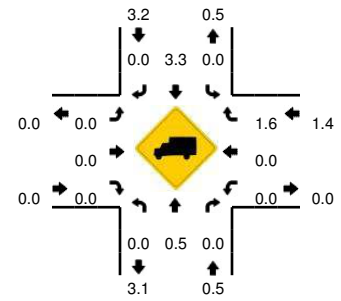
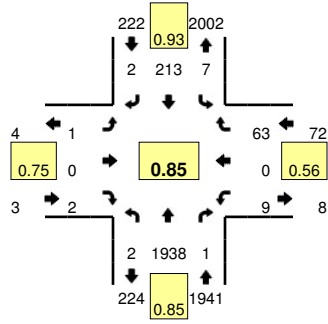

15-Min Count Period Beginning At	Carothers Pkwy (Northbound)				Carothers Pkwy (Southbound)				Resource Pkwy (Eastbound)				Resource Pkwy (Westbound)				Total	Hourly Totals
	Left	Thru	Right	U	Left	Thru	Right	U	Left	Thru	Right	U	Left	Thru	Right	U		
6:00 AM	1	68	1	0	0	10	0	1	0	0	0	0	1	0	4	0	86	
6:15 AM	1	104	0	0	1	20	1	0	0	0	0	0	6	0	6	0	139	
6:30 AM	3	154	0	0	0	23	1	1	0	0	0	0	5	0	10	0	197	
6:45 AM	2	235	0	0	0	51	1	0	0	0	1	0	4	0	15	0	309	731
7:00 AM	2	268	1	0	2	51	1	0	0	0	1	0	4	0	13	0	343	988
7:15 AM	2	392	0	0	1	34	0	0	0	0	0	0	3	0	12	0	444	1293
7:30 AM	2	440	0	0	3	51	1	0	0	0	0	0	4	0	7	0	508	1604
7:45 AM	0	570	0	0	1	49	0	0	1	0	0	0	2	0	33	0	656	1951
8:00 AM	0	510	0	0	2	63	0	0	0	0	1	0	1	0	15	0	592	2200
8:15 AM	0	418	1	0	1	50	1	0	0	0	1	0	2	0	8	0	482	2238
8:30 AM	0	322	1	0	2	64	0	0	0	0	0	0	2	0	14	0	405	2135
8:45 AM	0	279	0	0	2	59	1	0	0	0	1	0	2	0	7	0	351	1830
<b>Peak 15-Min Flowrates</b>	<b>Northbound</b>				<b>Southbound</b>				<b>Eastbound</b>				<b>Westbound</b>				<b>Total</b>	
All Vehicles	0	2280	0	0	4	196	0	0	4	0	0	0	8	0	132	0	2624	
Heavy Trucks	0	4	0	0	0	4	0	0	0	0	0	0	0	0	0	0	8	
Pedestrians	0	0	0	0	0	0	0	0	0	4	0	0	0	0	0	0	4	
Bicycles	0	0	0	0	0	0	0	0	0	0	0	0	0	0	0	0	0	
Railroad																		
Stopped Buses																		

Comments:

**LOCATION:** Carothers Pkwy -- Resource Pkwy  
**CITY/STATE:** Franklin , TN

**QC JOB #:** 13867214  
**DATE:** Thu, Aug 11 2016

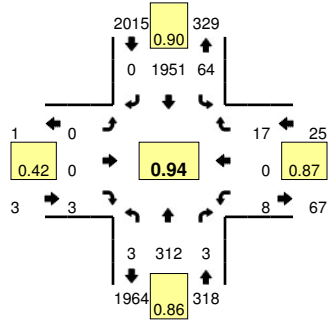

**Peak-Hour: 4:30 PM -- 5:30 PM**  
**Peak 15-Min: 5:00 PM -- 5:15 PM**

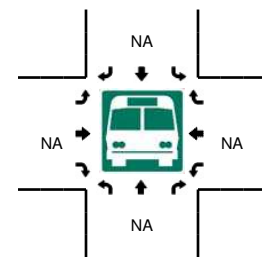
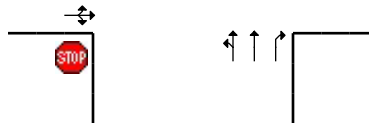
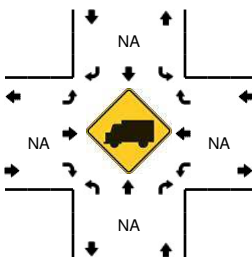
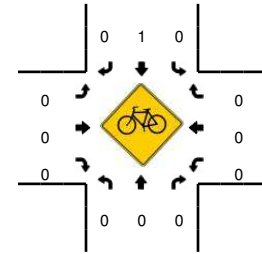
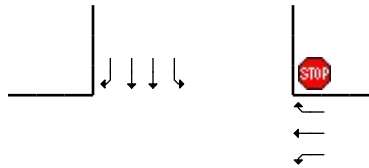
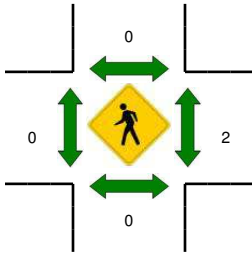
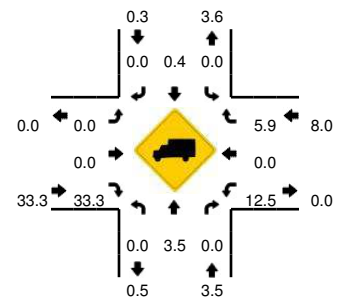

15-Min Count Period Beginning At	Carothers Pkwy (Northbound)				Carothers Pkwy (Southbound)				Resource Pkwy (Eastbound)				Resource Pkwy (Westbound)				Total	Hourly Totals
	Left	Thru	Right	U	Left	Thru	Right	U	Left	Thru	Right	U	Left	Thru	Right	U		
4:00 PM	0	64	1	1	9	437	0	0	1	0	1	0	3	0	5	0	522	
4:15 PM	0	67	3	0	13	401	0	0	0	0	0	0	1	0	3	0	488	
4:30 PM	0	90	1	1	4	512	0	0	0	0	0	0	3	0	4	0	615	
4:45 PM	1	79	0	1	15	406	0	0	0	0	1	0	3	0	3	0	509	2134
5:00 PM	0	63	2	0	23	535	0	0	0	0	2	0	0	0	4	0	629	2241
5:15 PM	0	80	0	0	22	498	0	0	0	0	0	0	2	0	6	0	608	2361
5:30 PM	0	71	0	0	21	403	0	1	0	0	6	0	0	0	6	0	508	2254
5:45 PM	0	65	2	1	14	282	0	0	0	0	1	0	1	0	10	0	376	2121
6:00 PM	0	56	0	0	14	264	0	0	0	0	1	0	1	0	11	0	347	1839
6:15 PM	1	53	3	0	15	164	0	0	0	0	2	0	2	0	13	0	253	1484
6:30 PM	0	51	1	0	11	127	0	0	0	0	0	0	0	0	14	0	204	1180
6:45 PM	0	53	1	0	11	88	0	0	0	0	0	0	0	0	5	0	158	962
<b>Peak 15-Min Flowrates</b>	<b>Northbound</b>				<b>Southbound</b>				<b>Eastbound</b>				<b>Westbound</b>				<b>Total</b>	
	Left	Thru	Right	U	Left	Thru	Right	U	Left	Thru	Right	U	Left	Thru	Right	U		
All Vehicles	0	252	8	0	92	2140	0	0	0	0	8	0	0	0	16	0	2516	
Heavy Trucks	0	4	0		0	4	0		0	0	4		0	0	4		16	
Pedestrians		0				0				0				0			0	
Bicycles	0	0	0		0	0	0		0	0	0		0	0	0		0	
Railroad																	0	
Stopped Buses																	0	

Comments:

**LOCATION:** Resource Pkwy -- E. McEwen Dr  
**CITY/STATE:** Franklin, TN

**QC JOB #:** 13867219  
**DATE:** Thu, Aug 11 2016

**Peak-Hour: 7:30 AM -- 8:30 AM**  
**Peak 15-Min: 7:45 AM -- 8:00 AM**

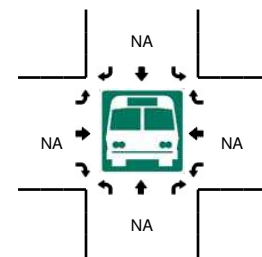
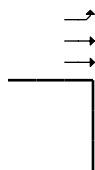
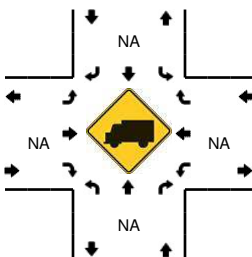
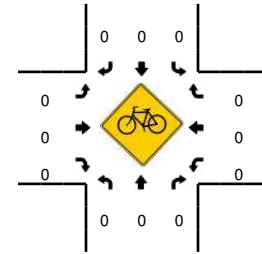
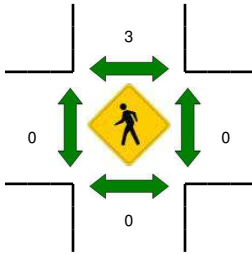
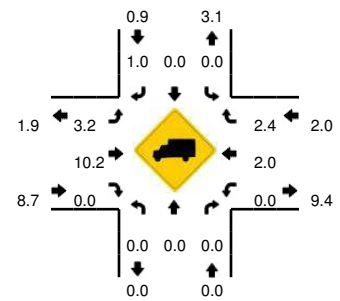
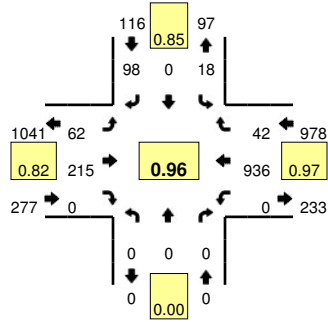

15-Min Count Period Beginning At	Resource Pkwy (Northbound)				Resource Pkwy (Southbound)				E. McEwen Dr (Eastbound)				E. McEwen Dr (Westbound)				Total	Hourly Totals
	Left	Thru	Right	U	Left	Thru	Right	U	Left	Thru	Right	U	Left	Thru	Right	U		
6:00 AM	0	0	0	0	0	0	10	0	1	17	0	0	0	37	0	0	65	
6:15 AM	0	0	0	0	1	0	18	0	2	32	0	0	0	53	0	0	106	
6:30 AM	0	0	0	0	3	0	20	0	3	43	0	0	0	121	2	0	192	
6:45 AM	0	0	0	0	6	0	21	0	5	53	0	0	0	156	4	0	245	608
7:00 AM	0	0	0	0	3	0	18	0	7	63	0	0	0	200	4	0	295	838
7:15 AM	0	0	0	0	2	0	20	0	20	51	0	0	0	192	9	1	295	1027
7:30 AM	0	0	0	0	3	0	31	0	12	43	0	1	0	233	15	0	338	1173
7:45 AM	0	0	0	0	3	0	20	0	21	63	0	2	0	239	8	0	356	1284
8:00 AM	0	0	0	0	10	0	19	0	11	56	0	2	0	223	8	0	329	1318
8:15 AM	0	0	0	0	2	0	28	0	11	53	0	2	0	241	11	0	348	1371
8:30 AM	0	0	0	0	0	0	13	0	11	49	0	2	0	196	8	0	279	1312
8:45 AM	0	0	0	0	1	0	13	2	14	41	0	1	0	197	5	0	274	1230
<b>Peak 15-Min Flowrates</b>	<b>Northbound</b>				<b>Southbound</b>				<b>Eastbound</b>				<b>Westbound</b>				<b>Total</b>	
	Left	Thru	Right	U	Left	Thru	Right	U	Left	Thru	Right	U	Left	Thru	Right	U		
All Vehicles	0	0	0	0	12	0	80	0	84	252	0	8	0	956	32	0	1424	
Heavy Trucks	0	0	0	0	0	0	0	0	0	28	0	0	0	32	0	0	60	
Pedestrians	0	0	0	0	0	0	0	0	0	0	0	0	0	0	0	0	0	
Bicycles	0	0	0	0	0	0	0	0	0	0	0	0	0	0	0	0	0	
Railroad																		
Stopped Buses																		

Comments:



**LOCATION:** Resource Pkwy -- E. McEwen Dr  
**CITY/STATE:** Franklin, TN

**QC JOB #:** 13867220  
**DATE:** Thu, Aug 11 2016

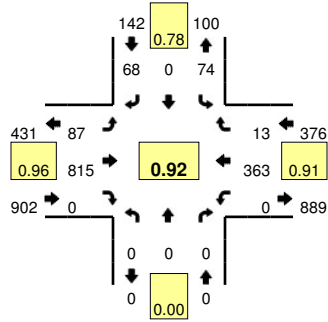

**Peak-Hour: 5:00 PM -- 6:00 PM**  
**Peak 15-Min: 5:15 PM -- 5:30 PM**

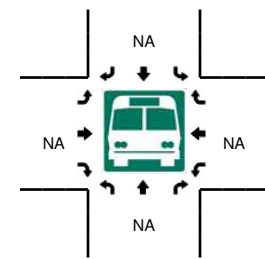
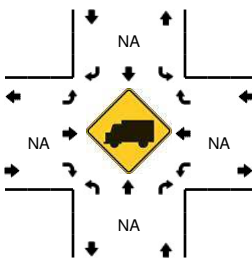
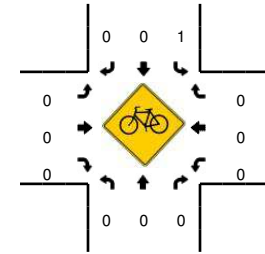
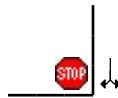
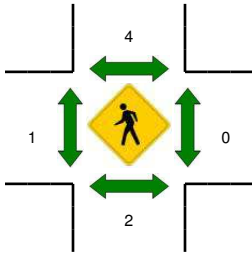
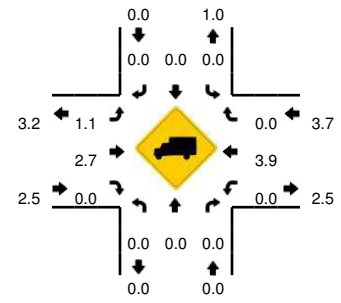

15-Min Count Period Beginning At	Resource Pkwy (Northbound)				Resource Pkwy (Southbound)				E. McEwen Dr (Eastbound)				E. McEwen Dr (Westbound)				Total	Hourly Totals
	Left	Thru	Right	U	Left	Thru	Right	U	Left	Thru	Right	U	Left	Thru	Right	U		
4:00 PM	0	0	0	0	14	0	12	0	30	164	0	0	0	71	6	0	297	
4:15 PM	0	0	0	0	12	0	12	0	13	140	0	1	0	76	3	0	257	
4:30 PM	0	0	0	0	8	0	21	0	24	185	0	0	0	83	5	0	326	
4:45 PM	0	0	0	0	11	0	16	0	24	191	0	0	0	81	0	0	323	1203
5:00 PM	0	0	0	0	24	0	23	0	13	221	0	0	0	80	1	0	362	1268
5:15 PM	0	0	0	0	26	0	23	0	24	208	0	0	0	99	4	0	384	1395
5:30 PM	0	0	0	0	13	0	11	0	22	193	0	0	0	94	3	0	336	1405
5:45 PM	0	0	0	0	11	0	11	0	28	193	0	0	0	90	5	0	338	1420
6:00 PM	0	0	0	0	8	0	13	0	23	161	0	0	0	74	4	0	283	1341
6:15 PM	0	0	0	0	4	0	19	0	15	123	0	0	0	69	3	0	233	1190
6:30 PM	0	0	0	0	3	0	9	0	15	113	0	0	0	72	4	0	216	1070
6:45 PM	0	0	0	0	2	0	9	0	19	107	0	0	0	53	4	0	194	926
<b>Peak 15-Min Flowrates</b>	<b>Northbound</b>				<b>Southbound</b>				<b>Eastbound</b>				<b>Westbound</b>				<b>Total</b>	
All Vehicles	0	0	0	0	104	0	92	0	96	832	0	0	0	396	16	0	1536	
Heavy Trucks	0	0	0	0	0	0	0	0	0	4	0	0	0	16	0	0	20	
Pedestrians	0	0	0	0	0	4	0	0	0	0	0	0	0	0	0	0	4	
Bicycles	0	0	0	0	0	0	0	0	0	0	0	0	0	0	0	0	0	
Railroad	0	0	0	0	0	0	0	0	0	0	0	0	0	0	0	0	0	
Stopped Buses	0	0	0	0	0	0	0	0	0	0	0	0	0	0	0	0	0	

Comments:

INTERSECTION TRAFFIC VOLUME COUNTS

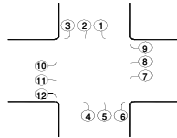

LOCATION: Resource Parkway and Pacific Drive  
 DATE: 7-Jul-15  
 RECORDER: City of Franklin  
 NOTES: unsignalized

LOCATION TIME	S/B Resource Parkway			N/B Resource Parkway			W/B Pacific Drive			E/B Pacific Drive			Hourly Total	15-min Total
	1	2	3	4	5	6	7	8	9	10	11	12		
6:30-6:45	0	1	0	0	4	0	1	0	2	0	0	0	28	8
6:45-7:00	0	1	0	0	1	0	0	2	0	0	0	0	32	4
7:00-7:15	0	0	0	1	0	0	0	0	1	0	0	0	47	2
7:15-7:30	1	0	1	0	4	1	1	3	2	0	1	0	57	14
7:30-7:45	0	0	0	0	8	0	1	2	1	0	0	0	54	12
7:45-8:00	0	0	0	2	9	0	1	1	5	1	0	0	58	19
8:00-8:15	0	0	2	2	6	0	0	0	0	0	0	2	49	12
8:15-8:30	0	1	0	0	5	0	1	0	3	0	1	0	41	11
8:30-8:45	1	2	1	0	8	0	0	0	2	1	0	1	38	16
8:45-9:00	0	0	5	1	3	0	1	0	0	0	0	0	28	10
9:00-9:15	0	0	0	0	0	0	0	2	1	0	0	1	29	4
9:15-9:30	0	1	0	0	4	0	0	0	2	0	0	1	37	8
9:30-9:45	0	1	1	0	2	0	0	0	2	0	0	0	39	6
9:45-10:00	2	1	0	0	5	0	0	2	0	0	0	1	44	11
10:00-10:15	1	2	2	1	2	0	0	2	1	1	0	0	45	12
10:15-10:30	0	0	2	1	0	0	0	1	2	1	2	1	47	10
10:30-10:45	3	2	2	1	2	0	0	0	1	0	0	0	48	11
10:45-11:00	1	2	0	1	1	0	0	1	3	1	1	1	52	12
11:00-11:15	0	3	1	1	5	0	0	2	0	1	0	1	55	14
11:15-11:30	0	3	1	0	0	2	0	0	2	0	2	1	57	11
11:30-11:45	0	2	0	0	4	0	1	0	4	1	2	1	62	15
11:45-12:00	1	3	1	0	4	1	0	0	0	0	2	3	69	15
12:00-12:15	2	3	0	1	5	0	0	1	2	0	0	2	67	16
12:15-12:30	1	3	1	2	2	0	1	2	0	1	3	0	69	16
12:30-12:45	3	10	1	1	4	0	0	0	0	1	1	1	69	22
12:45-1:00	2	4	1	0	2	0	0	3	0	0	1	0	62	13
1:00-1:15	2	1	0	2	5	0	0	2	4	0	2	0	60	18
1:15-1:30	0	5	0	0	4	0	0	1	2	0	2	2	48	16
1:30-1:45	0	4	0	1	5	0	0	1	3	0	0	1	40	15
1:45-2:00	0	1	0	1	3	0	1	0	0	2	2	1	33	11
2:00-2:15	0	1	0	1	3	0	0	1	0	0	0	0	35	6
2:15-2:30	0	3	0	0	1	1	0	0	0	1	0	2	41	8
2:30-2:45	0	4	1	1	1	0	0	0	1	0	0	0	38	8
2:45-3:00	1	1	2	0	2	1	1	2	0	0	2	1	38	13
3:00-3:15	2	3	0	0	3	0	0	0	1	0	1	2	35	12
3:15-3:30	0	2	1	0	0	0	0	0	0	0	1	1	41	5
3:30-3:45	0	0	0	1	0	0	0	2	1	2	1	1	42	8
3:45-4:00	2	2	1	1	1	1	0	0	0	1	0	1	45	10
4:00-4:15	1	9	2	0	3	0	0	0	0	1	0	2	55	18
4:15-4:30	1	2	0	0	0	0	1	0	0	1	0	1	63	6
4:30-4:45	1	3	0	0	0	1	1	0	0	1	2	2	75	11
4:45-5:00	3	9	0	1	1	0	0	1	1	0	1	3	79	20
5:00-5:15	3	11	2	1	0	1	0	1	0	0	2	5	80	26
5:15-5:30	3	4	0	0	2	0	0	1	1	4	2	1	73	18
5:30-5:45	2	6	2	1	2	0	0	0	0	0	0	2	74	15
5:45-6:00	4	5	1	1	6	0	1	2	0	0	1	0	21	
6:00-6:15	1	11	0	2	0	1	0	0	0	1	1	2	19	
6:15-6:30	0	5	0	2	2	1	0	1	0	2	3	3	19	
<b>TOTAL</b>	<b>44</b>	<b>137</b>	<b>34</b>	<b>31</b>	<b>134</b>	<b>11</b>	<b>13</b>	<b>37</b>	<b>50</b>	<b>27</b>	<b>39</b>	<b>50</b>		
<b>AM PK HR</b>	<b>1</b>	<b>3</b>	<b>3</b>	<b>4</b>	<b>28</b>	<b>0</b>	<b>2</b>	<b>1</b>	<b>10</b>	<b>2</b>	<b>1</b>	<b>3</b>	<b>7:45-8:45</b>	
<b>MID PK HR</b>	<b>7</b>	<b>19</b>	<b>3</b>	<b>4</b>	<b>15</b>	<b>1</b>	<b>1</b>	<b>3</b>	<b>2</b>	<b>2</b>	<b>6</b>	<b>6</b>	<b>11:45-12:45</b>	
<b>PM PK HR</b>	<b>12</b>	<b>26</b>	<b>5</b>	<b>3</b>	<b>10</b>	<b>1</b>	<b>1</b>	<b>4</b>	<b>1</b>	<b>4</b>	<b>5</b>	<b>8</b>	<b>5:00-6:00</b>	

<b>AM PK PHF</b>	0.25	0.38	0.38	0.50	0.78		0.50	0.25	0.50	0.50	0.25	0.38	<b>0.76</b>	<b>IS PHF (AM)</b>
<b>MID PK PHF</b>	0.88	0.48	0.75	0.50	0.75	0.25	0.25	0.38	0.25	0.50	0.50	0.50	<b>0.78</b>	<b>IS PHF (MID)</b>
<b>PM PK PHF</b>	0.75	0.59	0.63	0.75	0.42	0.25	0.25	0.50	0.25	0.25	0.63	0.40	<b>0.77</b>	<b>IS PHF (PM)</b>

**LOCATION:** Resource Pkwy -- Terrapin St  
**CITY/STATE:** Franklin, TN

**QC JOB #:** 13867215  
**DATE:** Thu, Aug 11 2016

**Peak-Hour: 7:15 AM -- 8:15 AM**  
**Peak 15-Min: 7:45 AM -- 8:00 AM**

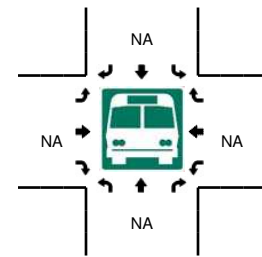
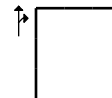
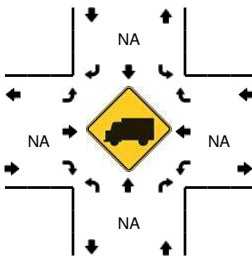
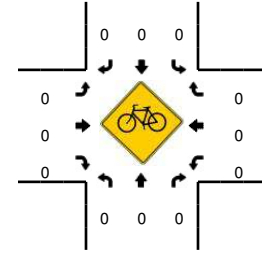
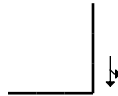
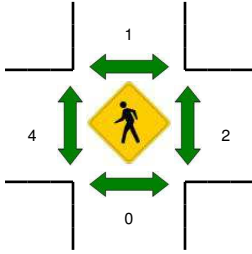
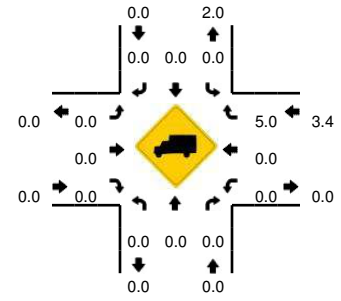
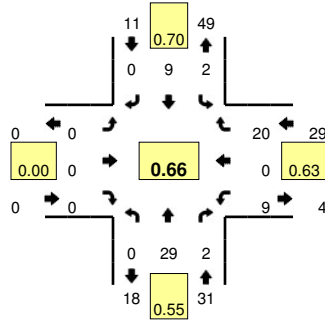

15-Min Count Period Beginning At	Resource Pkwy (Northbound)				Resource Pkwy (Southbound)				Terrapin St (Eastbound)				Terrapin St (Westbound)				Total	Hourly Totals
	Left	Thru	Right	U	Left	Thru	Right	U	Left	Thru	Right	U	Left	Thru	Right	U		
6:00 AM	0	3	0	0	1	0	0	0	0	0	0	0	1	0	0	0	5	
6:15 AM	0	0	0	0	1	2	0	0	0	0	0	0	2	0	2	0	7	
6:30 AM	0	4	1	0	0	1	0	0	0	0	0	0	1	0	1	0	8	
6:45 AM	0	4	0	0	0	5	0	0	0	0	0	0	3	0	3	0	15	35
7:00 AM	0	5	1	0	0	4	0	0	0	0	0	0	2	0	4	0	16	46
7:15 AM	0	3	1	0	0	0	0	0	0	0	0	0	3	0	4	0	11	50
7:30 AM	0	5	0	0	2	3	0	0	0	0	0	0	2	0	3	0	15	57
7:45 AM	0	14	0	0	0	1	0	0	0	0	0	0	2	0	10	0	27	69
8:00 AM	0	7	1	0	0	5	0	0	0	0	0	0	2	0	3	0	18	71
8:15 AM	0	3	0	0	0	1	0	0	0	0	0	0	3	0	3	0	10	70
8:30 AM	0	6	0	0	0	3	0	0	0	0	0	0	2	0	1	0	12	67
8:45 AM	0	4	0	0	1	3	0	0	0	0	0	0	0	0	0	0	8	48
<b>Peak 15-Min Flowrates</b>	<b>Northbound</b>				<b>Southbound</b>				<b>Eastbound</b>				<b>Westbound</b>				<b>Total</b>	
	Left	Thru	Right	U	Left	Thru	Right	U	Left	Thru	Right	U	Left	Thru	Right	U		
All Vehicles	0	56	0	0	0	4	0	0	0	0	0	0	8	0	40	0	108	
Heavy Trucks	0	0	0		0	0	0		0	0	0		0	0	0		0	
Pedestrians		0				0				8				4			12	
Bicycles	0	0	0		0	0	0		0	0	0		0	0	0		0	
Railroad																	0	
Stopped Buses																		

Comments:

**LOCATION:** Resource Pkwy -- Terrapin St  
**CITY/STATE:** Franklin, TN

**QC JOB #:** 13867216  
**DATE:** Thu, Aug 11 2016

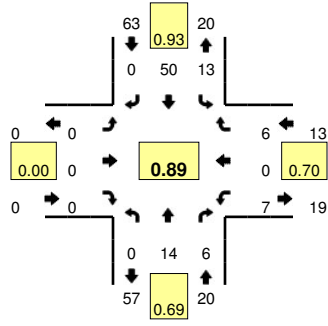

**Peak-Hour: 4:45 PM -- 5:45 PM**  
**Peak 15-Min: 5:30 PM -- 5:45 PM**

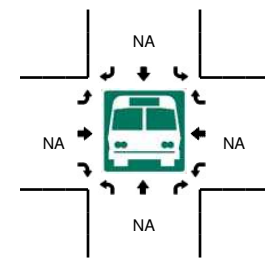
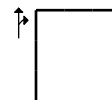
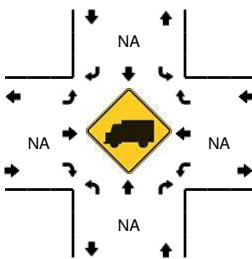
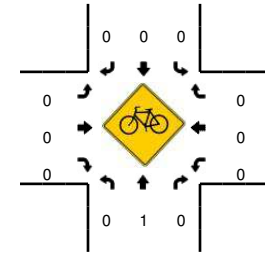
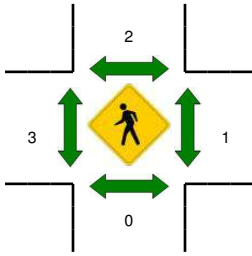
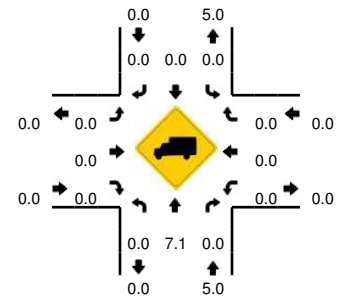

15-Min Count Period Beginning At	Resource Pkwy (Northbound)				Resource Pkwy (Southbound)				Terrapin St (Eastbound)				Terrapin St (Westbound)				Total	Hourly Totals
	Left	Thru	Right	U	Left	Thru	Right	U	Left	Thru	Right	U	Left	Thru	Right	U		
4:00 PM	0	7	2	0	0	7	0	0	0	0	0	0	1	0	2	0	19	
4:15 PM	0	2	2	0	3	8	0	0	0	0	0	0	1	0	0	0	16	
4:30 PM	0	5	0	0	3	5	0	0	0	0	0	0	1	0	3	0	17	
4:45 PM	0	1	2	0	3	11	0	0	0	0	0	0	3	0	2	0	22	74
5:00 PM	0	7	0	0	4	11	0	0	0	0	0	0	2	0	1	0	25	80
5:15 PM	0	2	1	0	2	15	0	0	0	0	0	0	1	0	1	0	22	86
5:30 PM	0	4	3	0	4	13	0	0	0	0	0	0	1	0	2	0	27	96
5:45 PM	0	5	0	0	1	9	0	0	0	0	0	0	0	0	2	0	17	91
6:00 PM	0	5	2	0	1	6	0	0	0	0	0	0	3	0	2	0	19	85
6:15 PM	0	2	2	0	2	6	0	0	0	0	0	0	1	0	2	0	15	78
6:30 PM	0	6	3	0	1	6	0	0	0	0	0	0	1	0	1	0	18	69
6:45 PM	0	1	4	0	2	3	0	1	0	0	0	0	2	0	0	0	13	65
Peak 15-Min Flowrates	Northbound				Southbound				Eastbound				Westbound				Total	
	Left	Thru	Right	U	Left	Thru	Right	U	Left	Thru	Right	U	Left	Thru	Right	U		
All Vehicles	0	16	12	0	16	52	0	0	0	0	0	0	4	0	8	0	108	
Heavy Trucks	0	0	0		0	0	0		0	0	0		0	0	0		0	
Pedestrians	0				4				8				0				12	
Bicycles	0	0	0		0	0	0		0	0	0		0	0	0		0	
Railroad																	0	
Stopped Buses																		

Comments:

**LOCATION:** Resource Pkwy -- Lemon Grass Dr  
**CITY/STATE:** Franklin, TN

**QC JOB #:** 13867217  
**DATE:** Thu, Aug 11 2016

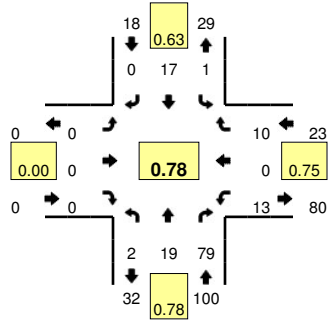

**Peak-Hour: 7:30 AM -- 8:30 AM**  
**Peak 15-Min: 7:45 AM -- 8:00 AM**

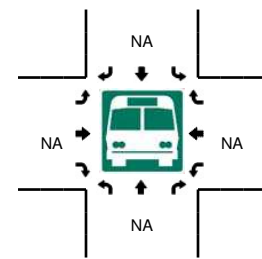
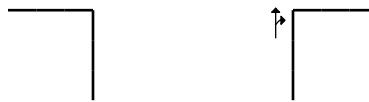
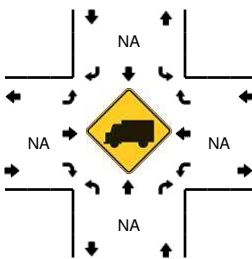
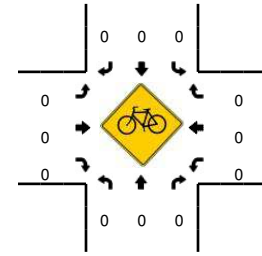
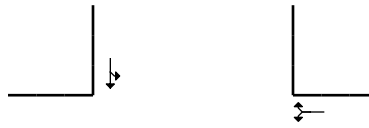
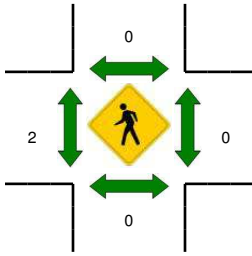
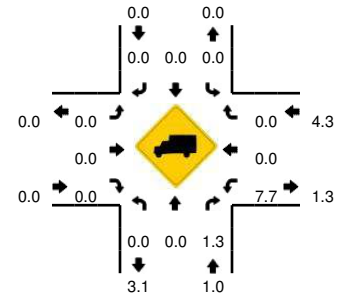

15-Min Count Period Beginning At	Resource Pkwy (Northbound)				Resource Pkwy (Southbound)				Lemon Grass Dr (Eastbound)				Lemon Grass Dr (Westbound)				Total	Hourly Totals
	Left	Thru	Right	U	Left	Thru	Right	U	Left	Thru	Right	U	Left	Thru	Right	U		
6:00 AM	0	1	1	0	0	1	0	0	0	0	0	0	2	0	2	0	7	
6:15 AM	0	0	0	0	1	3	0	0	0	0	0	0	1	0	0	0	5	
6:30 AM	0	2	2	0	0	2	0	0	0	0	0	0	4	0	3	0	13	
6:45 AM	0	1	3	0	0	8	0	0	0	0	0	0	1	0	2	0	15	40
7:00 AM	0	3	8	0	1	5	0	0	0	0	0	0	2	0	4	0	23	56
7:15 AM	0	3	19	0	0	3	0	0	0	0	0	0	0	0	2	0	27	78
7:30 AM	0	3	20	2	0	2	0	0	0	0	0	0	7	0	1	0	35	100
7:45 AM	0	7	25	0	0	5	0	0	0	0	0	0	1	0	7	0	45	130
8:00 AM	0	5	16	0	1	5	0	0	0	0	0	0	3	0	1	0	31	138
8:15 AM	0	4	18	0	0	5	0	0	0	0	0	0	2	0	1	0	30	141
8:30 AM	0	3	9	0	0	4	0	0	0	0	0	0	2	0	3	0	21	127
8:45 AM	0	3	8	0	2	1	0	1	0	0	0	0	4	0	0	0	19	101
<b>Peak 15-Min Flowrates</b>	<b>Northbound</b>				<b>Southbound</b>				<b>Eastbound</b>				<b>Westbound</b>				<b>Total</b>	
	Left	Thru	Right	U	Left	Thru	Right	U	Left	Thru	Right	U	Left	Thru	Right	U		
All Vehicles	0	28	100	0	0	20	0	0	0	0	0	0	4	0	28	0	180	
Heavy Trucks	0	0	0		0	0	0		0	0	0		0	0	0		0	
Pedestrians	0				0				4				0				4	
Bicycles	0	0	0		0	0	0		0	0	0		0	0	0		0	
Railroad																	0	
Stopped Buses																		

Comments:



**LOCATION:** Resource Pkwy -- Lemon Grass Dr  
**CITY/STATE:** Franklin, TN

**QC JOB #:** 13867218  
**DATE:** Thu, Aug 11 2016

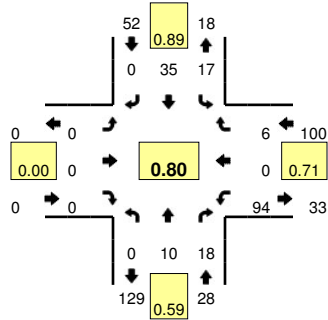

**Peak-Hour: 4:30 PM -- 5:30 PM**  
**Peak 15-Min: 5:00 PM -- 5:15 PM**

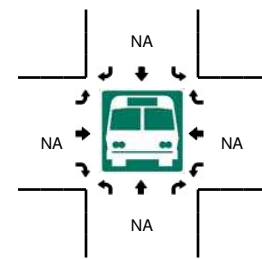
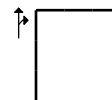
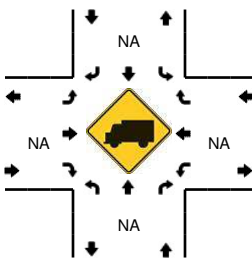
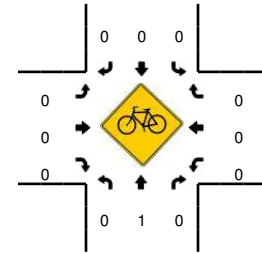
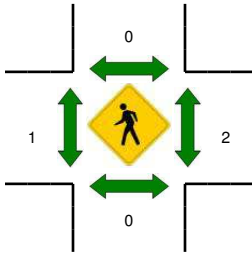
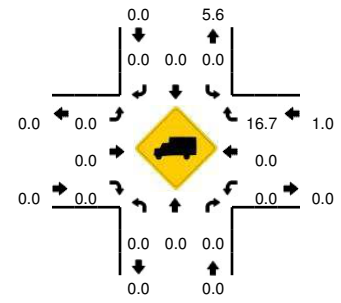

15-Min Count Period Beginning At	Resource Pkwy (Northbound)				Resource Pkwy (Southbound)				Lemon Grass Dr (Eastbound)				Lemon Grass Dr (Westbound)				Total	Hourly Totals
	Left	Thru	Right	U	Left	Thru	Right	U	Left	Thru	Right	U	Left	Thru	Right	U		
4:00 PM	0	10	5	2	1	8	0	0	0	0	0	0	12	0	0	0	38	
4:15 PM	0	3	4	0	1	6	0	0	0	0	0	0	12	0	1	0	27	
4:30 PM	0	3	4	0	4	4	0	0	0	0	0	0	20	0	2	0	37	
4:45 PM	0	3	6	0	4	9	0	0	0	0	0	0	17	0	0	0	39	141
5:00 PM	0	1	5	0	3	10	0	2	0	0	0	0	31	0	4	0	56	159
5:15 PM	0	3	3	0	4	12	0	0	0	0	0	0	26	0	0	0	48	180
5:30 PM	0	3	3	0	5	8	0	0	0	0	0	0	6	0	3	0	28	171
5:45 PM	0	5	4	0	4	6	0	0	0	0	0	0	4	0	1	0	24	156
6:00 PM	0	5	4	0	2	7	0	0	0	0	0	0	4	0	3	0	25	125
6:15 PM	0	2	5	0	2	6	0	0	0	0	0	0	1	0	2	0	18	95
6:30 PM	0	6	1	0	1	6	0	0	0	0	0	0	2	0	2	0	18	85
6:45 PM	0	5	5	0	2	3	0	0	0	0	0	0	3	0	1	0	19	80
Peak 15-Min Flowrates	Northbound				Southbound				Eastbound				Westbound				Total	
	Left	Thru	Right	U	Left	Thru	Right	U	Left	Thru	Right	U	Left	Thru	Right	U		
All Vehicles	0	4	20	0	12	40	0	8	0	0	0	0	124	0	16	0	224	
Heavy Trucks	0	0	0		0	0	0		0	0	0		0	0	4		4	
Pedestrians	0				0				0				0				0	
Bicycles	0	0	0		0	0	0		0	0	0		0	0	0		0	
Railroad																		
Stopped Buses																		

Comments:

**APPENDIX C  
CAPACITY ANALYSES**

**EXISTING CONDITIONS**

Lanes, Volumes, Timings

1: I65 NB off Ramp /I65 SB off ramp & McEwen/McEwen

11/18/2016

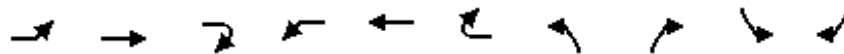

Lane Group	EBL	EBT	EBR2	WBL	WBT	WBR2	NBL	NBR2	SBL	SBR2
Lane Configurations	↖↖	↑↑	↗	↖	↑↑	↗	↖↖	↗	↖↖	↗↗
Traffic Volume (vph)	480	321	117	125	511	329	614	485	400	372
Future Volume (vph)	480	321	117	125	511	329	614	485	400	372
Ideal Flow (vphpl)	1900	1900	1900	1900	1900	1900	1900	1900	1900	1900
Storage Length (ft)	370			495			0		0	
Storage Lanes	2			1			2		2	
Taper Length (ft)	25			25			25		25	
Lane Util. Factor	0.97	0.95	1.00	1.00	0.95	1.00	0.97	1.00	0.97	0.88
Frt			0.850				0.850		0.850	0.850
Flt Protected	0.950			0.950			0.950		0.950	
Satd. Flow (prot)	3433	3539	1583	1770	3539	1583	3433	1583	3433	2787
Flt Permitted	0.950			0.950			0.950		0.950	
Satd. Flow (perm)	3433	3539	1583	1770	3539	1583	3433	1583	3433	2787
Right Turn on Red			Yes				Yes		Yes	Yes
Satd. Flow (RTOR)			182				329		405	165
Link Speed (mph)		30			30					
Link Distance (ft)		826			1211					
Travel Time (s)		18.8			27.5					
Peak Hour Factor	1.00	1.00	1.00	1.00	1.00	1.00	1.00	1.00	1.00	1.00
Adj. Flow (vph)	480	321	117	125	511	329	614	485	400	372
Shared Lane Traffic (%)										
Lane Group Flow (vph)	480	321	117	125	511	329	614	485	400	372
Enter Blocked Intersection	No	No	No	No	No	No	No	No	No	No
Lane Alignment	Left	Left	Right	Left	Left	Right	Left	Right	Left	Right
Median Width(ft)		24			24					
Link Offset(ft)		0			0					
Crosswalk Width(ft)		16			16					
Two way Left Turn Lane										
Headway Factor	1.00	1.00	1.00	1.00	1.00	1.00	1.00	1.00	1.00	1.00
Turning Speed (mph)	15		9	15		9	15	9	15	9
Number of Detectors	1	2	1	1	2	1	1	1	1	1
Detector Template	Left	Thru	Right	Left	Thru	Right	Left	Right	Left	Right
Leading Detector (ft)	20	100	20	20	100	20	20	20	20	20
Trailing Detector (ft)	0	0	0	0	0	0	0	0	0	0
Detector 1 Position(ft)	0	0	0	0	0	0	0	0	0	0
Detector 1 Size(ft)	20	6	20	20	6	20	20	20	20	20
Detector 1 Type	Cl+Ex	Cl+Ex	Cl+Ex	Cl+Ex	Cl+Ex	Cl+Ex	Cl+Ex	Cl+Ex	Cl+Ex	Cl+Ex
Detector 1 Channel										
Detector 1 Extend (s)	0.0	0.0	0.0	0.0	0.0	0.0	0.0	0.0	0.0	0.0
Detector 1 Queue (s)	0.0	0.0	0.0	0.0	0.0	0.0	0.0	0.0	0.0	0.0
Detector 1 Delay (s)	0.0	0.0	0.0	0.0	0.0	0.0	0.0	0.0	0.0	0.0
Detector 2 Position(ft)		94			94					
Detector 2 Size(ft)		6			6					
Detector 2 Type		Cl+Ex			Cl+Ex					
Detector 2 Channel										
Detector 2 Extend (s)		0.0			0.0					
Turn Type	Prot	NA	Free	Prot	NA	Perm	Perm	Free	Perm	Prot
Protected Phases	1	6		5	2					1
Permitted Phases			Free			2	3	Free	7	

# Lanes, Volumes, Timings

## 1: I65 NB off Ramp /I65 SB off ramp & McEwen/McEwen

11/18/2016

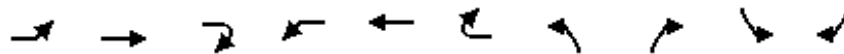

Lane Group	EBL	EBT	EBR2	WBL	WBT	WBR2	NBL	NBR2	SBL	SBR2
Detector Phase	1	6		5	2	2	3		7	1
Switch Phase										
Minimum Initial (s)	8.0	12.0		8.0	12.0	12.0	12.0		12.0	8.0
Minimum Split (s)	15.0	27.0		25.0	27.0	27.0	27.0		27.0	15.0
Total Split (s)	45.0	65.0		31.0	51.0	51.0	54.0		54.0	45.0
Total Split (%)	30.0%	43.3%		20.7%	34.0%	34.0%	36.0%		36.0%	30.0%
Maximum Green (s)	38.0	58.0		24.0	44.0	44.0	47.0		47.0	38.0
Yellow Time (s)	4.0	4.0		4.0	4.0	4.0	4.0		4.0	4.0
All-Red Time (s)	3.0	3.0		3.0	3.0	3.0	3.0		3.0	3.0
Lost Time Adjust (s)	0.0	0.0		0.0	0.0	0.0	0.0		0.0	0.0
Total Lost Time (s)	7.0	7.0		7.0	7.0	7.0	7.0		7.0	7.0
Lead/Lag	Lead	Lag		Lead	Lag	Lag				Lead
Lead-Lag Optimize?										
Vehicle Extension (s)	3.0	3.0		3.0	3.0	3.0	3.0		3.0	3.0
Recall Mode	None	C-Min		None	C-Min	C-Min	None		None	None
Walk Time (s)		7.0			7.0	7.0	7.0		7.0	
Flash Dont Walk (s)		13.0			13.0	13.0	13.0		13.0	
Pedestrian Calls (#/hr)		5			5	5	5		5	
Act Effct Green (s)	27.1	80.5	150.0	15.9	69.3	69.3	32.6	150.0	32.6	27.1
Actuated g/C Ratio	0.18	0.54	1.00	0.11	0.46	0.46	0.22	1.00	0.22	0.18
v/c Ratio	0.77	0.17	0.07	0.67	0.31	0.36	0.82	0.31	0.54	0.58
Control Delay	59.9	19.0	0.1	73.5	17.7	5.5	66.5	0.5	54.2	33.8
Queue Delay	0.0	0.0	0.0	0.0	0.0	0.0	0.0	0.0	0.0	0.0
Total Delay	59.9	19.0	0.1	73.5	17.7	5.5	66.5	0.5	54.2	33.8
LOS	E	B	A	E	B	A	E	A	D	C
Approach Delay		38.0			20.8					
Approach LOS		D			C					
90th %ile Green (s)	33.8	67.5		21.7	55.4	55.4	39.8		39.8	33.8
90th %ile Term Code	Gap	Coord		Gap	Coord	Coord	Gap		Hold	Gap
70th %ile Green (s)	29.6	75.4		18.3	64.1	64.1	35.3		35.3	29.6
70th %ile Term Code	Gap	Coord		Gap	Coord	Coord	Gap		Hold	Gap
50th %ile Green (s)	27.2	80.6		15.9	69.3	69.3	32.5		32.5	27.2
50th %ile Term Code	Gap	Coord		Gap	Coord	Coord	Gap		Hold	Gap
30th %ile Green (s)	24.8	85.8		13.5	74.5	74.5	29.7		29.7	24.8
30th %ile Term Code	Gap	Coord		Gap	Coord	Coord	Gap		Hold	Gap
10th %ile Green (s)	20.3	93.4		10.0	83.1	83.1	25.6		25.6	20.3
10th %ile Term Code	Gap	Coord		Gap	Coord	Coord	Gap		Hold	Gap
Stops (vph)	450	175	0	117	192	81	572	0	344	186
Fuel Used(gal)	11	4	1	4	8	4	15	3	9	6
CO Emissions (g/hr)	799	299	53	259	540	274	1055	203	611	409
NOx Emissions (g/hr)	155	58	10	50	105	53	205	40	119	80
VOC Emissions (g/hr)	185	69	12	60	125	64	244	47	142	95
Dilemma Vehicles (#)	0	0	0	0	0	0	0	0	0	0
Queue Length 50th (ft)	237	76	0	97	115	83	298	0	180	105
Queue Length 95th (ft)	323	206	0	224	97	60	397	0	250	189
Internal Link Dist (ft)		746			1131					
Turn Bay Length (ft)	370			495						
Base Capacity (vph)	869	1900	1583	283	1634	908	1075	1583	1075	829
Starvation Cap Reductn	0	0	0	0	0	0	0	0	0	0



Lanes, Volumes, Timings

1: I65 NB off Ramp /I65 SB off ramp & McEwen/McEwen

11/18/2016

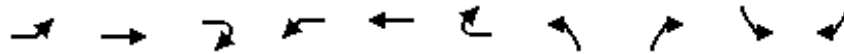

Lane Group	EBL	EBT	EBR2	WBL	WBT	WBR2	NBL	NBR2	SBL	SBR2
Spillback Cap Reductn	0	0	0	0	0	0	0	0	0	0
Storage Cap Reductn	0	0	0	0	0	0	0	0	0	0
Reduced v/c Ratio	0.55	0.17	0.07	0.44	0.31	0.36	0.57	0.31	0.37	0.45

Intersection Summary

Area Type:	Other
Cycle Length:	150
Actuated Cycle Length:	150
Offset:	58 (39%), Referenced to phase 2:WBT and 6:EBT, Start of Yellow
Natural Cycle:	80
Control Type:	Actuated-Coordinated
Maximum v/c Ratio:	0.82
Intersection Signal Delay:	34.7
Intersection LOS:	C
Intersection Capacity Utilization Err%	ICU Level of Service H
Analysis Period (min)	60

Splits and Phases: 1: I65 NB off Ramp /I65 SB off ramp & McEwen/McEwen

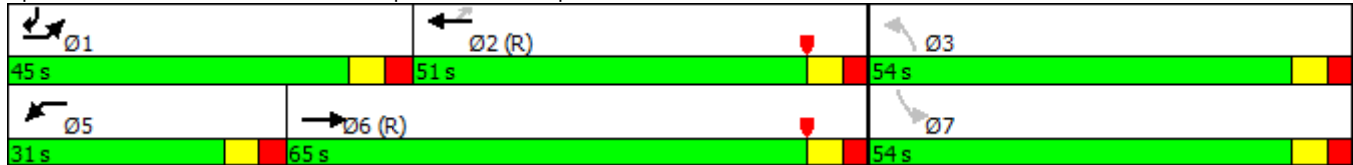

Lanes, Volumes, Timings  
2: McEwen /McEwen & Tower

11/18/2016

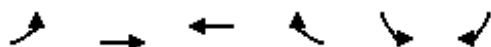

Lane Group	EBL	EBT	WBT	WBR	SBL	SBR
Lane Configurations	↖↖	↗↗	↖↖	↗	↘	↘↘
Traffic Volume (vph)	268	990	975	53	2	14
Future Volume (vph)	268	990	975	53	2	14
Ideal Flow (vphpl)	1900	1900	1900	1900	1900	1900
Storage Length (ft)	285			115	445	0
Storage Lanes	2			1	1	2
Taper Length (ft)	25				25	
Lane Util. Factor	0.97	0.95	0.95	1.00	1.00	0.88
Fr <sub>t</sub>				0.850		0.850
Fl <sub>t</sub> Protected	0.950				0.950	
Satd. Flow (prot)	3090	3185	3185	1425	1593	2508
Fl <sub>t</sub> Permitted	0.950				0.950	
Satd. Flow (perm)	3090	3185	3185	1425	1593	2508
Right Turn on Red				Yes		Yes
Satd. Flow (RTOR)				26		14
Link Speed (mph)		30	30		30	
Link Distance (ft)		1211	938		511	
Travel Time (s)		27.5	21.3		11.6	
Peak Hour Factor	1.00	1.00	1.00	1.00	1.00	1.00
Adj. Flow (vph)	268	990	975	53	2	14
Shared Lane Traffic (%)						
Lane Group Flow (vph)	268	990	975	53	2	14
Enter Blocked Intersection	No	No	No	No	No	No
Lane Alignment	Left	Left	Left	Right	Left	Right
Median Width(ft)		24	24		12	
Link Offset(ft)		0	0		0	
Crosswalk Width(ft)		16	16		16	
Two way Left Turn Lane						
Headway Factor	1.14	1.14	1.14	1.14	1.14	1.14
Turning Speed (mph)	15			9	15	9
Number of Detectors	1	2	2	1	1	1
Detector Template	Left	Thru	Thru	Right	Left	Right
Leading Detector (ft)	20	100	100	20	20	20
Trailing Detector (ft)	0	0	0	0	0	0
Detector 1 Position(ft)	0	0	0	0	0	0
Detector 1 Size(ft)	20	6	6	20	20	20
Detector 1 Type	Cl+Ex	Cl+Ex	Cl+Ex	Cl+Ex	Cl+Ex	Cl+Ex
Detector 1 Channel						
Detector 1 Extend (s)	0.0	0.0	0.0	0.0	0.0	0.0
Detector 1 Queue (s)	0.0	0.0	0.0	0.0	0.0	0.0
Detector 1 Delay (s)	0.0	0.0	0.0	0.0	0.0	0.0
Detector 2 Position(ft)		94	94			
Detector 2 Size(ft)		6	6			
Detector 2 Type		Cl+Ex	Cl+Ex			
Detector 2 Channel						
Detector 2 Extend (s)		0.0	0.0			
Turn Type	Prot	NA	NA	Prot	Prot	Prot
Protected Phases	1	6	2	2	8	8
Permitted Phases						

Lanes, Volumes, Timings  
2: McEwen /McEwen & Tower

11/18/2016

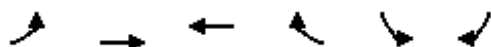

Lane Group	EBL	EBT	WBT	WBR	SBL	SBR
Detector Phase	1	6	2	2	8	8
Switch Phase						
Minimum Initial (s)	7.0	20.0	20.0	20.0	8.0	8.0
Minimum Split (s)	13.5	43.5	43.5	43.5	46.5	46.5
Total Split (s)	29.0	103.5	74.5	74.5	46.5	46.5
Total Split (%)	19.3%	69.0%	49.7%	49.7%	31.0%	31.0%
Maximum Green (s)	23.5	98.0	69.0	69.0	41.0	41.0
Yellow Time (s)	3.5	3.5	3.5	3.5	3.5	3.5
All-Red Time (s)	2.0	2.0	2.0	2.0	2.0	2.0
Lost Time Adjust (s)	0.0	0.0	0.0	0.0	0.0	0.0
Total Lost Time (s)	5.5	5.5	5.5	5.5	5.5	5.5
Lead/Lag	Lead		Lag	Lag		
Lead-Lag Optimize?						
Vehicle Extension (s)	3.0	3.0	3.0	3.0	3.0	3.0
Recall Mode	None	C-Min	C-Min	C-Min	None	None
Walk Time (s)		7.0	7.0	7.0	7.0	7.0
Flash Dont Walk (s)		18.0	18.0	18.0	34.0	34.0
Pedestrian Calls (#/hr)		3	3	3	3	3
Act Effct Green (s)	18.2	132.0	106.1	106.1	14.6	14.6
Actuated g/C Ratio	0.12	0.88	0.71	0.71	0.10	0.10
v/c Ratio	0.71	0.35	0.43	0.05	0.01	0.05
Control Delay	77.6	3.9	7.8	2.5	51.5	20.6
Queue Delay	0.0	0.0	0.0	0.0	0.0	0.0
Total Delay	77.6	3.9	7.8	2.5	51.5	20.6
LOS	E	A	A	A	D	C
Approach Delay		19.6	7.5		24.4	
Approach LOS		B	A		C	
90th %ile Green (s)	23.1	98.0	69.4	69.4	41.0	41.0
90th %ile Term Code	Gap	Coord	Coord	Coord	Ped	Ped
70th %ile Green (s)	20.2	131.0	105.3	105.3	8.0	8.0
70th %ile Term Code	Gap	Coord	Coord	Coord	Min	Min
50th %ile Green (s)	18.3	131.0	107.2	107.2	8.0	8.0
50th %ile Term Code	Gap	Coord	Coord	Coord	Min	Min
30th %ile Green (s)	16.3	144.5	122.7	122.7	0.0	0.0
30th %ile Term Code	Gap	Coord	Coord	Coord	Skip	Skip
10th %ile Green (s)	13.3	144.5	125.7	125.7	0.0	0.0
10th %ile Term Code	Gap	Coord	Coord	Coord	Skip	Skip
Stops (vph)	253	165	386	6	3	5
Fuel Used(gal)	8	11	11	0	0	0
CO Emissions (g/hr)	571	772	756	31	3	10
NOx Emissions (g/hr)	111	150	147	6	1	2
VOC Emissions (g/hr)	132	179	175	7	1	2
Dilemma Vehicles (#)	0	0	0	0	0	0
Queue Length 50th (ft)	131	24	184	2	2	0
Queue Length 95th (ft)	204	374	m90	m1	9	12
Internal Link Dist (ft)		1131	858		431	
Turn Bay Length (ft)	285			115	445	
Base Capacity (vph)	484	2802	2252	1015	435	695
Starvation Cap Reductn	0	0	0	0	0	0

Lanes, Volumes, Timings  
 2: McEwen /McEwen & Tower

11/18/2016

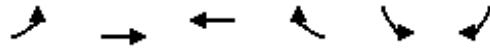

Lane Group	EBL	EBT	WBT	WBR	SBL	SBR
Spillback Cap Reductn	0	0	0	0	0	0
Storage Cap Reductn	0	0	0	0	0	0
Reduced v/c Ratio	0.55	0.35	0.43	0.05	0.00	0.02

Intersection Summary

Area Type:	CBD
Cycle Length:	150
Actuated Cycle Length:	150
Offset:	54 (36%), Referenced to phase 2:WBT and 6:EBT, Start of Yellow
Natural Cycle:	105
Control Type:	Actuated-Coordinated
Maximum v/c Ratio:	0.71
Intersection Signal Delay:	14.2
Intersection LOS:	B
Intersection Capacity Utilization	58.9%
ICU Level of Service	B
Analysis Period (min)	60

m Volume for 95th percentile queue is metered by upstream signal.

Splits and Phases: 2: McEwen /McEwen & Tower



Lanes, Volumes, Timings  
3: Carothers/Carothers & McEwen

11/18/2016



Lane Group	EBL	EBT	EBR	WBL	WBT	WBR	NBL	NBT	NBR	SBL	SBT	SBR
Lane Configurations	↖↖	↗↗	↘	↖↖	↗↗	↘	↖↖	↗↗	↘	↖↖	↗↗	↘
Traffic Volume (vph)	668	193	117	103	650	268	171	903	55	7	98	102
Future Volume (vph)	668	193	117	103	650	268	171	903	55	7	98	102
Ideal Flow (vphpl)	1900	1900	1900	1900	1900	1900	1900	1900	1900	1900	1900	1900
Storage Length (ft)	205		205	218		97	300		300	280		310
Storage Lanes	2		1	2		1	2		1	2		1
Taper Length (ft)	25			25			25			25		
Lane Util. Factor	0.97	0.95	1.00	0.97	0.95	1.00	0.97	0.95	1.00	0.97	0.95	1.00
Frt			0.850			0.850			0.850			0.850
Flt Protected	0.950			0.950			0.950			0.950		
Satd. Flow (prot)	3433	3539	1583	3433	3539	1583	3433	3539	1583	3433	3539	1583
Flt Permitted	0.950			0.950			0.950			0.950		
Satd. Flow (perm)	3433	3539	1583	3433	3539	1583	3433	3539	1583	3433	3539	1583
Right Turn on Red			Yes			Yes			Yes			Yes
Satd. Flow (RTOR)			117			105			109			65
Link Speed (mph)		30			30			30				40
Link Distance (ft)		938			1960			1936				857
Travel Time (s)		21.3			44.5			44.0				14.6
Peak Hour Factor	1.00	1.00	1.00	1.00	1.00	1.00	1.00	1.00	1.00	1.00	1.00	1.00
Adj. Flow (vph)	668	193	117	103	650	268	171	903	55	7	98	102
Shared Lane Traffic (%)												
Lane Group Flow (vph)	668	193	117	103	650	268	171	903	55	7	98	102
Enter Blocked Intersection	No	No	No	No	No	No	No	No	No	No	No	No
Lane Alignment	Left	Left	Right	Left	Left	Right	Left	Left	Right	Left	Left	Right
Median Width(ft)		24			24			24				24
Link Offset(ft)		0			0			0				0
Crosswalk Width(ft)		16			16			16				16
Two way Left Turn Lane												
Headway Factor	1.00	1.00	1.00	1.00	1.00	1.00	1.00	1.00	1.00	1.00	1.00	1.00
Turning Speed (mph)	15		9	15		9	15		9	15		9
Number of Detectors	1	2	1	1	2	1	1	2	1	1	2	1
Detector Template	Left	Thru	Right	Left	Thru	Right	Left	Thru	Right	Left	Thru	Right
Leading Detector (ft)	20	100	20	20	100	20	20	100	20	20	100	20
Trailing Detector (ft)	0	0	0	0	0	0	0	0	0	0	0	0
Detector 1 Position(ft)	0	0	0	0	0	0	0	0	0	0	0	0
Detector 1 Size(ft)	20	6	20	20	6	20	20	6	20	20	6	20
Detector 1 Type	Cl+Ex	Cl+Ex	Cl+Ex	Cl+Ex	Cl+Ex	Cl+Ex	Cl+Ex	Cl+Ex	Cl+Ex	Cl+Ex	Cl+Ex	Cl+Ex
Detector 1 Channel												
Detector 1 Extend (s)	0.0	0.0	0.0	0.0	0.0	0.0	0.0	0.0	0.0	0.0	0.0	0.0
Detector 1 Queue (s)	0.0	0.0	0.0	0.0	0.0	0.0	0.0	0.0	0.0	0.0	0.0	0.0
Detector 1 Delay (s)	0.0	0.0	0.0	0.0	0.0	0.0	0.0	0.0	0.0	0.0	0.0	0.0
Detector 2 Position(ft)		94			94			94				94
Detector 2 Size(ft)		6			6			6				6
Detector 2 Type		Cl+Ex			Cl+Ex			Cl+Ex				Cl+Ex
Detector 2 Channel												
Detector 2 Extend (s)		0.0			0.0			0.0				0.0
Turn Type	Prot	NA	pm+ov	Prot	NA	pm+ov	Prot	NA	custom	Prot	NA	custom
Protected Phases	1	6	7	5	2	3	7	4	5	3	8	1
Permitted Phases			6			2			8			4



Lanes, Volumes, Timings  
3: Carothers/Carothers & McEwen

11/18/2016



Lane Group	EBL	EBT	EBR	WBL	WBT	WBR	NBL	NBT	NBR	SBL	SBT	SBR
Detector Phase	1	6	7	5	2	3	7	4	5	3	8	1
Switch Phase												
Minimum Initial (s)	6.0	13.0	6.0	4.0	13.0	6.0	6.0	13.0	4.0	6.0	13.0	6.0
Minimum Split (s)	13.0	52.0	12.5	10.0	52.0	13.0	12.5	52.0	10.0	13.0	52.0	13.0
Total Split (s)	32.0	70.2	13.8	14.0	52.2	13.0	13.8	52.8	14.0	13.0	52.0	32.0
Total Split (%)	21.3%	46.8%	9.2%	9.3%	34.8%	8.7%	9.2%	35.2%	9.3%	8.7%	34.7%	21.3%
Maximum Green (s)	26.0	64.2	7.8	8.5	46.2	7.0	7.8	46.8	8.5	7.0	46.0	26.0
Yellow Time (s)	4.0	4.0	4.0	3.5	4.0	4.0	4.0	4.0	3.5	4.0	4.0	4.0
All-Red Time (s)	2.0	2.0	2.0	2.0	2.0	2.0	2.0	2.0	2.0	2.0	2.0	2.0
Lost Time Adjust (s)	0.0	0.0	0.0	0.0	0.0	0.0	0.0	0.0	0.0	0.0	0.0	0.0
Total Lost Time (s)	6.0	6.0	6.0	5.5	6.0	6.0	6.0	6.0	5.5	6.0	6.0	6.0
Lead/Lag	Lead	Lag	Lead	Lead	Lag	Lead	Lead	Lag	Lead	Lead	Lag	Lead
Lead-Lag Optimize?												
Vehicle Extension (s)	3.0	3.0	3.0	3.0	3.0	3.0	3.0	3.0	3.0	3.0	3.0	3.0
Recall Mode	Max	C-Max	None	None	C-Max	None	None	None	None	None	None	Max
Walk Time (s)		7.0			7.0			7.0			7.0	
Flash Dont Walk (s)		39.0			39.0			37.0			37.0	
Pedestrian Calls (#/hr)		5			5			5			5	
Act Effct Green (s)	29.5	67.6	81.4	8.5	46.2	58.5	7.8	44.0	57.1	6.3	42.5	79.5
Actuated g/C Ratio	0.20	0.45	0.54	0.06	0.31	0.39	0.05	0.29	0.38	0.04	0.28	0.53
v/c Ratio	0.99	0.12	0.13	0.53	0.60	0.39	0.96	0.87	0.08	0.05	0.10	0.12
Control Delay	113.5	20.8	4.6	79.2	46.8	21.2	170.9	61.2	0.2	77.7	35.2	6.5
Queue Delay	159.2	0.0	0.0	0.0	0.0	0.0	0.0	0.0	0.0	0.0	0.0	0.0
Total Delay	272.7	20.8	4.6	79.2	46.8	21.2	170.9	61.2	0.2	77.7	35.2	6.5
LOS	F	C	A	E	D	C	F	E	A	E	D	A
Approach Delay		190.9			43.3			74.8			22.5	
Approach LOS		F			D			E			C	
90th %ile Green (s)	26.0	64.2	7.8	8.5	46.2	6.8	7.8	47.0	8.5	6.8	46.0	26.0
90th %ile Term Code	MaxR	Coord	Max	Max	Coord	Gap	Max	Max	Max	Gap	Hold	MaxR
70th %ile Green (s)	26.0	64.2	7.8	8.5	46.2	6.4	7.8	47.4	8.5	6.4	46.0	26.0
70th %ile Term Code	MaxR	Coord	Max	Max	Coord	Gap	Max	Max	Max	Gap	Hold	MaxR
50th %ile Green (s)	27.6	64.4	7.8	9.9	46.2	6.2	7.8	46.0	9.9	6.2	44.4	27.6
50th %ile Term Code	MaxR	Coord	Max	Gap	Coord	Gap	Max	Gap	Gap	Gap	Hold	MaxR
30th %ile Green (s)	31.3	69.3	7.8	8.7	46.2	6.0	7.8	42.5	8.7	6.0	40.7	31.3
30th %ile Term Code	MaxR	Coord	Max	Gap	Coord	Min	Max	Gap	Gap	Min	Hold	MaxR
10th %ile Green (s)	36.5	76.1	7.8	7.1	46.2	6.0	7.8	37.3	7.1	6.0	35.5	36.5
10th %ile Term Code	MaxR	Coord	Max	Gap	Coord	Min	Max	Gap	Gap	Min	Hold	MaxR
Stops (vph)	500	85	17	98	539	117	151	838	0	9	59	22
Fuel Used(gal)	23	3	1	4	19	6	9	30	1	0	2	1
CO Emissions (g/hr)	1613	189	74	264	1335	412	655	2063	58	17	129	66
NOx Emissions (g/hr)	314	37	14	51	260	80	127	401	11	3	25	13
VOC Emissions (g/hr)	374	44	17	61	309	96	152	478	13	4	30	15
Dilemma Vehicles (#)	0	0	0	0	0	0	0	0	0	0	2	0
Queue Length 50th (ft)	~348	43	10	51	284	111	87	434	0	3	38	25
Queue Length 95th (ft)	#622	70	44	94	403	227	#195	#630	4	m14	47	16
Internal Link Dist (ft)		858			1880			1856			777	
Turn Bay Length (ft)	205		205	218		97	300		300	280		310
Base Capacity (vph)	674	1595	913	201	1090	688	178	1108	672	160	1085	869
Starvation Cap Reductn	0	0	0	0	0	0	0	0	0	0	0	0

Lanes, Volumes, Timings  
 3: Carothers/Carothers & McEwen

11/18/2016

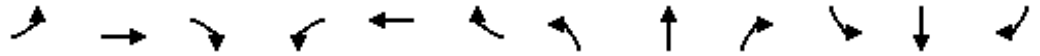

Lane Group	EBL	EBT	EBR	WBL	WBT	WBR	NBL	NBT	NBR	SBL	SBT	SBR
Spillback Cap Reductn	102	0	0	0	0	3	0	0	0	0	0	0
Storage Cap Reductn	0	0	0	0	0	0	0	0	0	0	0	0
Reduced v/c Ratio	1.17	0.12	0.13	0.51	0.60	0.39	0.96	0.81	0.08	0.04	0.09	0.12

Intersection Summary

Area Type:	Other
Cycle Length:	150
Actuated Cycle Length:	150
Offset:	8 (5%), Referenced to phase 2:WBT and 6:EBT, Start of Yellow
Natural Cycle:	130
Control Type:	Actuated-Coordinated
Maximum v/c Ratio:	0.99
Intersection Signal Delay:	96.0
Intersection LOS:	F
Intersection Capacity Utilization	77.0%
ICU Level of Service	D
Analysis Period (min)	60

- ~ Volume exceeds capacity, queue is theoretically infinite.  
 Queue shown is maximum after two cycles.
- # 95th percentile volume exceeds capacity, queue may be longer.  
 Queue shown is maximum after two cycles.
- m Volume for 95th percentile queue is metered by upstream signal.

Splits and Phases: 3: Carothers/Carothers & McEwen



Lanes, Volumes, Timings  
4: Ovation/Resource Parkway & McEwen

11/18/2016































Lane Group	EBL	EBT	EBR	WBL	WBT	WBR	NBL	NBT	NBR	SBL	SBT	SBR
Lane Configurations												
Traffic Volume (vph)	62	215	0	0	936	42	0	0	0	18	0	98
Future Volume (vph)	62	215	0	0	936	42	0	0	0	18	0	98
Ideal Flow (vphpl)	1900	1900	1900	1900	1900	1900	1900	1900	1900	1900	1900	1900
Lane Util. Factor	1.00	0.95	1.00	1.00	0.95	0.95	1.00	1.00	1.00	1.00	1.00	1.00
Fr <sub>t</sub>					0.994							0.850
Fl <sub>t</sub> Protected	0.950									0.950		
Satd. Flow (prot)	1770	3539	0	0	3518	0	0	0	0	1770	0	1583
Fl <sub>t</sub> Permitted	0.950									0.950		
Satd. Flow (perm)	1770	3539	0	0	3518	0	0	0	0	1770	0	1583
Link Speed (mph)		30			30				30			30
Link Distance (ft)		1960			345				402			456
Travel Time (s)		44.5			7.8				9.1			10.4
Peak Hour Factor	1.00	1.00	1.00	1.00	1.00	1.00	1.00	1.00	1.00	1.00	1.00	1.00
Adj. Flow (vph)	62	215	0	0	936	42	0	0	0	18	0	98
Shared Lane Traffic (%)												
Lane Group Flow (vph)	62	215	0	0	978	0	0	0	0	18	0	98
Enter Blocked Intersection	No	No	No	No	No	No	No	No	No	No	No	No
Lane Alignment	Left	Left	Right	Left	Left	Right	Left	Left	Right	Left	Left	Right
Median Width(ft)		36			36				12			12
Link Offset(ft)		0			0				0			0
Crosswalk Width(ft)		16			16				16			16
Two way Left Turn Lane												
Headway Factor	1.00	1.00	1.00	1.00	1.00	1.00	1.00	1.00	1.00	1.00	1.00	1.00
Turning Speed (mph)	15		9	15		9	15		9	15		9
Sign Control		Free			Free			Stop				Stop

Intersection Summary

Area Type:	Other
Control Type:	Unsignalized
Intersection Capacity Utilization	44.0%
Analysis Period (min)	60
	ICU Level of Service A

Lanes, Volumes, Timings  
5: Carothers /Carothers & Tower/Pacific

11/18/2016

												
Lane Group	EBL	EBT	EBR	WBL	WBT	WBR	NBL	NBT	NBR	SBL	SBT	SBR
Lane Configurations	 		 	 		 	 	 	 			
Traffic Volume (vph)	8	0	3	28	1	14	13	1854	6	3	189	17
Future Volume (vph)	8	0	3	28	1	14	13	1854	6	3	189	17
Ideal Flow (vphpl)	1900	1900	1900	1900	1900	1900	1900	1900	1900	1900	1900	1900
Grade (%)		0%			0%			2%			0%	
Storage Length (ft)	84		78	106		77	177		100	85		144
Storage Lanes	2		1	1		1	1		1	1		1
Taper Length (ft)	25			25			25			25		
Lane Util. Factor	0.97	1.00	1.00	1.00	1.00	1.00	1.00	0.95	1.00	1.00	0.95	1.00
Fr <sub>t</sub>			0.850				0.850			0.850		0.850
Fl <sub>t</sub> Protected	0.950			0.950			0.950			0.950		
Satd. Flow (prot)	3433	1863	1583	1770	1863	1583	1752	3504	1567	1770	3539	1583
Fl <sub>t</sub> Permitted	0.950			0.950			0.624			0.065		
Satd. Flow (perm)	3433	1863	1583	1770	1863	1583	1151	3504	1567	121	3539	1583
Right Turn on Red			Yes			Yes			Yes			Yes
Satd. Flow (RTOR)			676			102			98			98
Link Speed (mph)		30			30			40			30	
Link Distance (ft)		881			890			857			905	
Travel Time (s)		20.0			20.2			14.6			20.6	
Peak Hour Factor	1.00	1.00	1.00	1.00	1.00	1.00	1.00	1.00	1.00	1.00	1.00	1.00
Adj. Flow (vph)	8	0	3	28	1	14	13	1854	6	3	189	17
Shared Lane Traffic (%)												
Lane Group Flow (vph)	8	0	3	28	1	14	13	1854	6	3	189	17
Enter Blocked Intersection	No	No	No	No	No	No	No	No	No	No	No	No
Lane Alignment	Left	Left	Right	Left	Left	Right	Left	Left	Right	Left	Left	Right
Median Width(ft)		24			24			24			24	
Link Offset(ft)		0			0			0			0	
Crosswalk Width(ft)		16			16			16			16	
Two way Left Turn Lane												
Headway Factor	1.00	1.00	1.00	1.00	1.00	1.00	1.01	1.01	1.01	1.00	1.00	1.00
Turning Speed (mph)	15		9	15		9	15		9	15		9
Number of Detectors	1	2	1	1	2	1	1	2	1	1	2	1
Detector Template	Left	Thru	Right	Left	Thru	Right	Left	Thru	Right	Left	Thru	Right
Leading Detector (ft)	20	100	20	20	100	20	20	100	20	20	100	20
Trailing Detector (ft)	0	0	0	0	0	0	0	0	0	0	0	0
Detector 1 Position(ft)	0	0	0	0	0	0	0	0	0	0	0	0
Detector 1 Size(ft)	20	6	20	20	6	20	20	6	20	20	6	20
Detector 1 Type	Cl+Ex	Cl+Ex	Cl+Ex	Cl+Ex	Cl+Ex	Cl+Ex	Cl+Ex	Cl+Ex	Cl+Ex	Cl+Ex	Cl+Ex	Cl+Ex
Detector 1 Channel												
Detector 1 Extend (s)	0.0	0.0	0.0	0.0	0.0	0.0	0.0	0.0	0.0	0.0	0.0	0.0
Detector 1 Queue (s)	0.0	0.0	0.0	0.0	0.0	0.0	0.0	0.0	0.0	0.0	0.0	0.0
Detector 1 Delay (s)	0.0	0.0	0.0	0.0	0.0	0.0	0.0	0.0	0.0	0.0	0.0	0.0
Detector 2 Position(ft)		94			94			94			94	
Detector 2 Size(ft)		6			6			6			6	
Detector 2 Type		Cl+Ex			Cl+Ex			Cl+Ex			Cl+Ex	
Detector 2 Channel												
Detector 2 Extend (s)		0.0			0.0			0.0			0.0	
Turn Type	Prot		Perm	Prot	NA	Perm	pm+pt	NA	Perm	pm+pt	NA	Perm
Protected Phases	3	8		7	4		1	6		5	2	

Lanes, Volumes, Timings  
5: Carothers /Carothers & Tower/Pacific

11/18/2016



Lane Group	EBL	EBT	EBR	WBL	WBT	WBR	NBL	NBT	NBR	SBL	SBT	SBR
Permitted Phases			8			4	6		6	2		2
Detector Phase	3	8	8	7	4	4	1	6	6	5	2	2
Switch Phase												
Minimum Initial (s)	6.0	8.0	8.0	6.0	8.0	8.0	6.0	20.0	20.0	6.0	20.0	20.0
Minimum Split (s)	12.5	48.5	48.5	12.5	48.5	48.5	12.0	42.0	42.0	12.0	42.0	42.0
Total Split (s)	12.5	48.5	48.5	12.5	48.5	48.5	12.0	77.0	77.0	12.0	77.0	77.0
Total Split (%)	8.3%	32.3%	32.3%	8.3%	32.3%	32.3%	8.0%	51.3%	51.3%	8.0%	51.3%	51.3%
Maximum Green (s)	7.0	43.0	43.0	7.0	43.0	43.0	6.5	71.0	71.0	6.5	71.0	71.0
Yellow Time (s)	3.5	3.5	3.5	3.5	3.5	3.5	3.5	4.0	4.0	3.5	4.0	4.0
All-Red Time (s)	2.0	2.0	2.0	2.0	2.0	2.0	2.0	2.0	2.0	2.0	2.0	2.0
Lost Time Adjust (s)	0.0	0.0	0.0	0.0	0.0	0.0	0.0	0.0	0.0	0.0	0.0	0.0
Total Lost Time (s)	5.5	5.5	5.5	5.5	5.5	5.5	5.5	6.0	6.0	5.5	6.0	6.0
Lead/Lag	Lead	Lag	Lag	Lead	Lag	Lag	Lead	Lag	Lag	Lead	Lag	Lag
Lead-Lag Optimize?												
Vehicle Extension (s)	3.0	3.0	3.0	3.0	3.0	3.0	3.0	3.0	3.0	3.0	3.0	3.0
Recall Mode	None	None	None	None	None	None	None	C-Min	C-Min	None	C-Min	C-Min
Walk Time (s)		7.0	7.0		7.0	7.0		7.0	7.0		7.0	7.0
Flash Dont Walk (s)		36.0	36.0		36.0	36.0		29.0	29.0		29.0	29.0
Pedestrian Calls (#/hr)		10	10		10	10		10	10		10	10
Act Effct Green (s)	6.1		22.0	6.9	24.6	24.6	116.4	117.0	117.0	115.0	114.5	114.5
Actuated g/C Ratio	0.04		0.15	0.05	0.16	0.16	0.78	0.78	0.78	0.77	0.76	0.76
v/c Ratio	0.06		0.00	0.35	0.00	0.04	0.01	0.68	0.00	0.02	0.07	0.01
Control Delay	69.9		0.0	81.4	38.0	0.2	4.5	10.9	0.0	13.3	12.1	0.0
Queue Delay	0.0		0.0	0.0	0.0	0.0	0.0	0.1	0.0	0.0	0.0	0.0
Total Delay	69.9		0.0	81.4	38.0	0.2	4.5	11.0	0.0	13.3	12.1	0.0
LOS	E		A	F	D	A	A	B	A	B	B	A
Approach Delay					54.0			10.9			11.1	
Approach LOS					D			B			B	
90th %ile Green (s)	6.6	43.0	43.0	7.0	43.4	43.4	6.5	71.5	71.5	6.0	71.0	71.0
90th %ile Term Code	Gap	Ped	Ped	Max	Hold	Hold	Max	Coord	Coord	Min	Coord	Coord
70th %ile Green (s)	0.0	43.0	43.0	7.0	55.5	55.5	6.3	83.0	83.0	0.0	71.2	71.2
70th %ile Term Code	Skip	Ped	Ped	Max	Hold	Hold	Gap	Coord	Coord	Skip	Coord	Coord
50th %ile Green (s)	0.0	0.0	0.0	8.0	8.0	8.0	0.0	130.5	130.5	0.0	130.5	130.5
50th %ile Term Code	Skip	Skip	Skip	Hold	Min	Min	Skip	Coord	Coord	Skip	Coord	Coord
30th %ile Green (s)	0.0	0.0	0.0	0.0	0.0	0.0	0.0	144.0	144.0	0.0	144.0	144.0
30th %ile Term Code	Skip	Skip	Skip	Skip	Skip	Skip	Skip	Coord	Coord	Skip	Coord	Coord
10th %ile Green (s)	0.0	0.0	0.0	0.0	0.0	0.0	0.0	144.0	144.0	0.0	144.0	144.0
10th %ile Term Code	Skip	Skip	Skip	Skip	Skip	Skip	Skip	Coord	Coord	Skip	Coord	Coord
Stops (vph)	10		0	28	1	0	1	584	0	2	58	0
Fuel Used(gal)	0		0	1	0	0	0	21	0	0	2	0
CO Emissions (g/hr)	16		1	57	1	7	7	1443	2	3	148	8
NOx Emissions (g/hr)	3		0	11	0	1	1	281	0	1	29	2
VOC Emissions (g/hr)	4		0	13	0	2	2	334	1	1	34	2
Dilemma Vehicles (#)	0		0	0	0	0	0	49	0	0	0	0
Queue Length 50th (ft)	4		0	27	1	0	1	132	0	0	10	0
Queue Length 95th (ft)	15		0	70	6	0	m2	m#1308	m0	7	87	0
Internal Link Dist (ft)		801			810			777			825	
Turn Bay Length (ft)	84		78	106		77	177		100	85		144
Base Capacity (vph)	160		936	84	566	551	919	2733	1244	164	2702	1231



Lanes, Volumes, Timings  
 5: Carothers /Carothers & Tower/Pacific

11/18/2016



Lane Group	EBL	EBT	EBR	WBL	WBT	WBR	NBL	NBT	NBR	SBL	SBT	SBR
Starvation Cap Reductn	0		0	0	0	0	0	95	0	0	0	0
Spillback Cap Reductn	0		0	0	0	0	0	0	0	0	0	0
Storage Cap Reductn	0		0	0	0	0	0	0	0	0	0	0
Reduced v/c Ratio	0.05		0.00	0.33	0.00	0.03	0.01	0.70	0.00	0.02	0.07	0.01

Intersection Summary























Area Type: Other  
 Cycle Length: 150  
 Actuated Cycle Length: 150  
 Offset: 120 (80%), Referenced to phase 2:SBTL and 6:NBTL, Start of Yellow  
 Natural Cycle: 115  
 Control Type: Actuated-Coordinated  
 Maximum v/c Ratio: 0.68  
 Intersection Signal Delay: 12.0 Intersection LOS: B  
 Intersection Capacity Utilization 77.1% ICU Level of Service D  
 Analysis Period (min) 60  
 # 95th percentile volume exceeds capacity, queue may be longer.  
 Queue shown is maximum after two cycles.  
 m Volume for 95th percentile queue is metered by upstream signal.

Splits and Phases: 5: Carothers /Carothers & Tower/Pacific

Ø1	Ø2 (R)	Ø3	Ø4
12 s	77 s	12.5 s	48.5 s
Ø5	Ø6 (R)	Ø7	Ø8
12 s	77 s	12.5 s	48.5 s

Lanes, Volumes, Timings  
 6: Carothers/Carothers Parkway & Apartments/Resource

11/18/2016

												
Lane Group	EBL	EBT	EBR	WBL	WBT	WBR	NBL	NBT	NBR	SBL	SBT	SBR
Lane Configurations												
Traffic Volume (vph)	1	0	2	9	0	63	2	1938	1	7	213	2
Future Volume (vph)	1	0	2	9	0	63	2	1938	1	7	213	2
Ideal Flow (vphpl)	1900	1900	1900	1900	1900	1900	1900	1900	1900	1900	1900	1900
Grade (%)		0%			0%			2%			0%	
Storage Length (ft)	0		0	0		0	210		128	480		93
Storage Lanes	1		0	1		1	1		0	1		1
Taper Length (ft)	25			25			25			25		
Lane Util. Factor	1.00	1.00	1.00	1.00	1.00	1.00	1.00	0.95	0.95	1.00	0.95	1.00
Frt		0.850				0.850						0.850
Flt Protected	0.950			0.950			0.950			0.950		
Satd. Flow (prot)	1770	1583	0	1770	1863	1583	1752	3504	0	1770	3539	1583
Flt Permitted	0.950			0.950			0.950			0.950		
Satd. Flow (perm)	1770	1583	0	1770	1863	1583	1752	3504	0	1770	3539	1583
Link Speed (mph)		30			30			40			40	
Link Distance (ft)		762			773			905			2004	
Travel Time (s)		17.3			17.6			15.4			34.2	
Peak Hour Factor	1.00	1.00	1.00	1.00	1.00	1.00	1.00	1.00	1.00	1.00	1.00	1.00
Adj. Flow (vph)	1	0	2	9	0	63	2	1938	1	7	213	2
Shared Lane Traffic (%)												
Lane Group Flow (vph)	1	2	0	9	0	63	2	1939	0	7	213	2
Enter Blocked Intersection	No	No	No	No	No	No	No	No	No	No	No	No
Lane Alignment	Left	Left	Right	Left	Left	Right	Left	Left	Right	Left	Left	Right
Median Width(ft)		12			12			12			12	
Link Offset(ft)		0			0			0			0	
Crosswalk Width(ft)		16			16			16			16	
Two way Left Turn Lane												
Headway Factor	1.00	1.00	1.00	1.00	1.00	1.00	1.01	1.01	1.01	1.00	1.00	1.00
Turning Speed (mph)	15		9	15		9	15		9	15		9
Sign Control		Stop			Stop			Free			Free	
<b>Intersection Summary</b>												
Area Type:	Other											
Control Type:	Unsignalized											
Intersection Capacity Utilization	70.8%						ICU Level of Service C					
Analysis Period (min)	60											

Lanes, Volumes, Timings

1: I65 NB off Ramp /I65 SB off ramp & McEwen/McEwen

11/18/2016

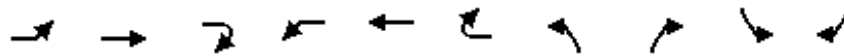

Lane Group	EBL	EBT	EBR2	WBL	WBT	WBR2	NBL	NBR2	SBL	SBR2
Lane Configurations										
Traffic Volume (vph)	572	604	366	300	564	623	285	75	462	671
Future Volume (vph)	572	604	366	300	564	623	285	75	462	671
Ideal Flow (vphpl)	1900	1900	1900	1900	1900	1900	1900	1900	1900	1900
Storage Length (ft)	370			495			0		0	
Storage Lanes	2			1			2		2	
Taper Length (ft)	25			25			25		25	
Lane Util. Factor	0.97	0.95	1.00	1.00	0.95	1.00	0.97	1.00	0.97	0.88
Frt			0.850				0.850		0.850	0.850
Flt Protected	0.950			0.950			0.950		0.950	
Satd. Flow (prot)	3433	3539	1583	1770	3539	1583	3433	1583	3433	2787
Flt Permitted	0.950			0.950			0.950		0.950	
Satd. Flow (perm)	3433	3539	1583	1770	3539	1583	3433	1583	3433	2787
Right Turn on Red			Yes			Yes		Yes		Yes
Satd. Flow (RTOR)			366			616		245		284
Link Speed (mph)		30			30					
Link Distance (ft)		826			1211					
Travel Time (s)		18.8			27.5					
Peak Hour Factor	1.00	1.00	1.00	1.00	1.00	1.00	1.00	1.00	1.00	1.00
Adj. Flow (vph)	572	604	366	300	564	623	285	75	462	671
Shared Lane Traffic (%)										
Lane Group Flow (vph)	572	604	366	300	564	623	285	75	462	671
Enter Blocked Intersection	No	No	No	No	No	No	No	No	No	No
Lane Alignment	Left	Left	Right	Left	Left	Right	Left	Right	Left	Right
Median Width(ft)		24			24					
Link Offset(ft)		0			0					
Crosswalk Width(ft)		16			16					
Two way Left Turn Lane										
Headway Factor	1.00	1.00	1.00	1.00	1.00	1.00	1.00	1.00	1.00	1.00
Turning Speed (mph)	15		9	15		9	15	9	15	9
Number of Detectors	1	2	1	1	2	1	1	1	1	1
Detector Template	Left	Thru	Right	Left	Thru	Right	Left	Right	Left	Right
Leading Detector (ft)	20	100	20	20	100	20	20	20	20	20
Trailing Detector (ft)	0	0	0	0	0	0	0	0	0	0
Detector 1 Position(ft)	0	0	0	0	0	0	0	0	0	0
Detector 1 Size(ft)	20	6	20	20	6	20	20	20	20	20
Detector 1 Type	Cl+Ex	Cl+Ex	Cl+Ex	Cl+Ex	Cl+Ex	Cl+Ex	Cl+Ex	Cl+Ex	Cl+Ex	Cl+Ex
Detector 1 Channel										
Detector 1 Extend (s)	0.0	0.0	0.0	0.0	0.0	0.0	0.0	0.0	0.0	0.0
Detector 1 Queue (s)	0.0	0.0	0.0	0.0	0.0	0.0	0.0	0.0	0.0	0.0
Detector 1 Delay (s)	0.0	0.0	0.0	0.0	0.0	0.0	0.0	0.0	0.0	0.0
Detector 2 Position(ft)		94			94					
Detector 2 Size(ft)		6			6					
Detector 2 Type		Cl+Ex			Cl+Ex					
Detector 2 Channel										
Detector 2 Extend (s)		0.0			0.0					
Turn Type	Prot	NA	Free	Prot	NA	Perm	Perm	Free	Perm	Prot
Protected Phases	1	6		5	2					1
Permitted Phases			Free			2	3	Free	7	

Lanes, Volumes, Timings

1: I65 NB off Ramp /I65 SB off ramp & McEwen/McEwen

11/18/2016

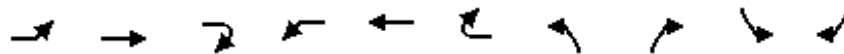

Lane Group	EBL	EBT	EBR2	WBL	WBT	WBR2	NBL	NBR2	SBL	SBR2
Detector Phase	1	6		5	2	2	3		7	1
Switch Phase										
Minimum Initial (s)	8.0	12.0		8.0	12.0	12.0	12.0		12.0	8.0
Minimum Split (s)	15.0	27.0		25.0	27.0	27.0	27.0		27.0	15.0
Total Split (s)	23.0	28.0		25.0	30.0	30.0	27.0		27.0	23.0
Total Split (%)	28.8%	35.0%		31.3%	37.5%	37.5%	33.8%		33.8%	28.8%
Maximum Green (s)	16.0	21.0		18.0	23.0	23.0	20.0		20.0	16.0
Yellow Time (s)	4.0	4.0		4.0	4.0	4.0	4.0		4.0	4.0
All-Red Time (s)	3.0	3.0		3.0	3.0	3.0	3.0		3.0	3.0
Lost Time Adjust (s)	0.0	0.0		0.0	0.0	0.0	0.0		0.0	0.0
Total Lost Time (s)	7.0	7.0		7.0	7.0	7.0	7.0		7.0	7.0
Lead/Lag	Lead	Lag		Lead	Lag	Lag				Lead
Lead-Lag Optimize?										
Vehicle Extension (s)	3.0	3.0		3.0	3.0	3.0	3.0		3.0	3.0
Recall Mode	None	Min		None	Min	Min	None		None	None
Walk Time (s)		7.0			7.0	7.0	7.0		7.0	
Flash Dont Walk (s)		13.0			13.0	13.0	13.0		13.0	
Pedestrian Calls (#/hr)		5			5	5	5		5	
Act Effct Green (s)	15.5	19.6	72.0	15.9	20.0	20.0	15.4	72.0	15.4	15.5
Actuated g/C Ratio	0.22	0.27	1.00	0.22	0.28	0.28	0.21	1.00	0.21	0.22
v/c Ratio	0.78	0.63	0.23	0.77	0.57	0.70	0.39	0.05	0.63	0.82
Control Delay	37.1	27.2	0.3	43.5	25.3	7.4	26.6	0.1	30.7	26.6
Queue Delay	0.0	0.0	0.0	0.0	0.0	0.0	0.0	0.0	0.0	0.0
Total Delay	37.1	27.2	0.3	43.5	25.3	7.4	26.6	0.1	30.7	26.6
LOS	D	C	A	D	C	A	C	A	C	C
Approach Delay		24.5			21.5					
Approach LOS		C			C					
90th %ile Green (s)	16.0	21.0		18.0	23.0	23.0	20.0		20.0	16.0
90th %ile Term Code	Max	Max		Max	Max	Max	Ped		Max	Max
70th %ile Green (s)	16.0	21.0		18.0	23.0	23.0	17.1		17.1	16.0
70th %ile Term Code	Max	Max		Max	Max	Max	Hold		Gap	Max
50th %ile Green (s)	16.0	20.8		18.0	22.8	22.8	15.2		15.2	16.0
50th %ile Term Code	Max	Hold		Max	Gap	Gap	Hold		Gap	Max
30th %ile Green (s)	16.0	19.9		14.9	18.8	18.8	13.0		13.0	16.0
30th %ile Term Code	Max	Hold		Gap	Gap	Gap	Hold		Gap	Max
10th %ile Green (s)	13.0	15.2		11.0	13.2	13.2	12.0		12.0	13.0
10th %ile Term Code	Gap	Hold		Gap	Gap	Gap	Min		Min	Gap
Stops (vph)	495	503	0	258	454	74	228	0	397	348
Fuel Used(gal)	11	10	2	7	11	7	4	0	8	10
CO Emissions (g/hr)	750	700	167	483	751	506	314	31	551	674
NOx Emissions (g/hr)	146	136	32	94	146	98	61	6	107	131
VOC Emissions (g/hr)	174	162	39	112	174	117	73	7	128	156
Dilemma Vehicles (#)	0	0	0	0	0	0	0	0	0	0
Queue Length 50th (ft)	130	128	0	128	113	2	59	0	102	97
Queue Length 95th (ft)	#268	225	0	#308	201	#178	105	0	169	#269
Internal Link Dist (ft)		746			1131					
Turn Bay Length (ft)	370			495						
Base Capacity (vph)	771	1043	1583	447	1143	928	964	1583	964	846
Starvation Cap Reductn	0	0	0	0	0	0	0	0	0	0

Lanes, Volumes, Timings

1: I65 NB off Ramp /I65 SB off ramp & McEwen/McEwen

11/18/2016

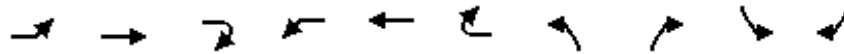

Lane Group	EBL	EBT	EBR2	WBL	WBT	WBR2	NBL	NBR2	SBL	SBR2
Spillback Cap Reductn	0	0	0	0	0	0	0	0	0	0
Storage Cap Reductn	0	0	0	0	0	0	0	0	0	0
Reduced v/c Ratio	0.74	0.58	0.23	0.67	0.49	0.67	0.30	0.05	0.48	0.79

Intersection Summary

Area Type:	Other
Cycle Length:	80
Actuated Cycle Length:	72
Natural Cycle:	80
Control Type:	Actuated-Uncoordinated
Maximum v/c Ratio:	0.82
Intersection Signal Delay:	24.2
Intersection LOS:	C
Intersection Capacity Utilization Err%	ICU Level of Service H
Analysis Period (min)	60
90th %ile Actuated Cycle:	80
70th %ile Actuated Cycle:	77.1
50th %ile Actuated Cycle:	75
30th %ile Actuated Cycle:	68.8
10th %ile Actuated Cycle:	59.2
# 95th percentile volume exceeds capacity, queue may be longer. Queue shown is maximum after two cycles.	

Splits and Phases: 1: I65 NB off Ramp /I65 SB off ramp & McEwen/McEwen

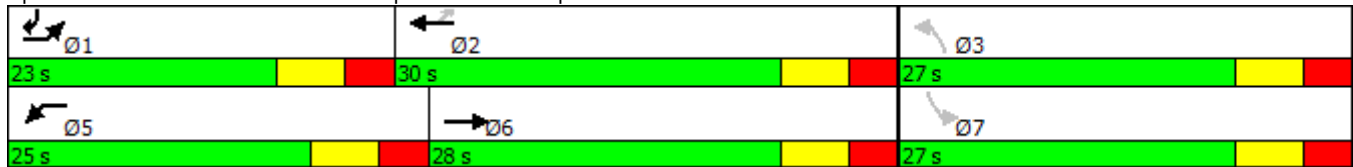

Lanes, Volumes, Timings  
2: McEwen /McEwen & Tower

11/18/2016

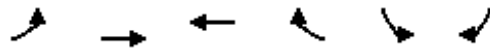

Lane Group	EBL	EBT	WBT	WBR	SBL	SBR
Lane Configurations	↖↖	↗↗	↖↖	↗	↘	↘↘
Traffic Volume (vph)	27	1108	1167	0	106	308
Future Volume (vph)	27	1108	1167	0	106	308
Ideal Flow (vphpl)	1900	1900	1900	1900	1900	1900
Storage Length (ft)	285			115	445	0
Storage Lanes	2			1	1	2
Taper Length (ft)	25				25	
Lane Util. Factor	0.97	0.95	0.95	1.00	1.00	0.88
Flt						0.850
Flt Protected	0.950				0.950	
Satd. Flow (prot)	3090	3185	3185	1676	1593	2508
Flt Permitted	0.950				0.950	
Satd. Flow (perm)	3090	3185	3185	1676	1593	2508
Right Turn on Red				Yes		Yes
Satd. Flow (RTOR)						308
Link Speed (mph)		30	30		30	
Link Distance (ft)		1211	938		511	
Travel Time (s)		27.5	21.3		11.6	
Peak Hour Factor	1.00	1.00	1.00	1.00	1.00	1.00
Adj. Flow (vph)	27	1108	1167	0	106	308
Shared Lane Traffic (%)						
Lane Group Flow (vph)	27	1108	1167	0	106	308
Enter Blocked Intersection	No	No	No	No	No	No
Lane Alignment	Left	Left	Left	Right	Left	Right
Median Width(ft)		24	24		12	
Link Offset(ft)		0	0		0	
Crosswalk Width(ft)		16	16		16	
Two way Left Turn Lane						
Headway Factor	1.14	1.14	1.14	1.14	1.14	1.14
Turning Speed (mph)	15			9	15	9
Number of Detectors	1	2	2	1	1	1
Detector Template	Left	Thru	Thru	Right	Left	Right
Leading Detector (ft)	20	100	100	20	20	20
Trailing Detector (ft)	0	0	0	0	0	0
Detector 1 Position(ft)	0	0	0	0	0	0
Detector 1 Size(ft)	20	6	6	20	20	20
Detector 1 Type	Cl+Ex	Cl+Ex	Cl+Ex	Cl+Ex	Cl+Ex	Cl+Ex
Detector 1 Channel						
Detector 1 Extend (s)	0.0	0.0	0.0	0.0	0.0	0.0
Detector 1 Queue (s)	0.0	0.0	0.0	0.0	0.0	0.0
Detector 1 Delay (s)	0.0	0.0	0.0	0.0	0.0	0.0
Detector 2 Position(ft)		94	94			
Detector 2 Size(ft)		6	6			
Detector 2 Type		Cl+Ex	Cl+Ex			
Detector 2 Channel						
Detector 2 Extend (s)		0.0	0.0			
Turn Type	Prot	NA	NA	Prot	Prot	Prot
Protected Phases	1	6	2	2	8	8
Permitted Phases						



Lanes, Volumes, Timings  
2: McEwen /McEwen & Tower

11/18/2016

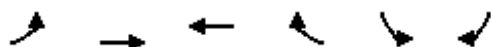

Lane Group	EBL	EBT	WBT	WBR	SBL	SBR
Detector Phase	1	6	2	2	8	8
Switch Phase						
Minimum Initial (s)	7.0	20.0	20.0	20.0	8.0	8.0
Minimum Split (s)	13.5	43.5	43.5	43.5	46.5	46.5
Total Split (s)	13.5	58.5	45.0	45.0	46.5	46.5
Total Split (%)	12.9%	55.7%	42.9%	42.9%	44.3%	44.3%
Maximum Green (s)	8.0	53.0	39.5	39.5	41.0	41.0
Yellow Time (s)	3.5	3.5	3.5	3.5	3.5	3.5
All-Red Time (s)	2.0	2.0	2.0	2.0	2.0	2.0
Lost Time Adjust (s)	0.0	0.0	0.0	0.0	0.0	0.0
Total Lost Time (s)	5.5	5.5	5.5	5.5	5.5	5.5
Lead/Lag	Lead		Lag	Lag		
Lead-Lag Optimize?						
Vehicle Extension (s)	3.0	3.0	3.0	3.0	3.0	3.0
Recall Mode	None	Min	Min	Min	None	None
Walk Time (s)		7.0	7.0	7.0	7.0	7.0
Flash Dont Walk (s)		18.0	18.0	18.0	34.0	34.0
Pedestrian Calls (#/hr)		3	3	3	3	3
Act Effct Green (s)	7.8	39.5	35.6		14.1	14.1
Actuated g/C Ratio	0.12	0.60	0.54		0.21	0.21
v/c Ratio	0.07	0.58	0.68		0.31	0.39
Control Delay	36.6	11.1	17.5		25.8	4.6
Queue Delay	0.0	0.0	0.0		0.0	0.0
Total Delay	36.6	11.1	17.5		25.8	4.6
LOS	D	B	B		C	A
Approach Delay		11.8	17.5		10.0	
Approach LOS		B	B		B	
90th %ile Green (s)	7.6	53.0	39.9	39.9	41.0	41.0
90th %ile Term Code	Gap	Max	Hold	Hold	Ped	Ped
70th %ile Green (s)	7.0	52.0	39.5	39.5	11.7	11.7
70th %ile Term Code	Min	Hold	Max	Max	Gap	Gap
50th %ile Green (s)	0.0	37.6	37.6	37.6	10.1	10.1
50th %ile Term Code	Skip	Hold	Gap	Gap	Gap	Gap
30th %ile Green (s)	0.0	28.2	28.2	28.2	8.0	8.0
30th %ile Term Code	Skip	Hold	Gap	Gap	Min	Min
10th %ile Green (s)	0.0	24.3	24.3	24.3	8.0	8.0
10th %ile Term Code	Skip	Hold	Gap	Gap	Min	Min
Stops (vph)	25	595	711		76	28
Fuel Used(gal)	1	16	17		1	2
CO Emissions (g/hr)	42	1137	1163		98	117
NOx Emissions (g/hr)	8	221	226		19	23
VOC Emissions (g/hr)	10	263	269		23	27
Dilemma Vehicles (#)	0	0	0		0	0
Queue Length 50th (ft)	4	94	101		34	0
Queue Length 95th (ft)	25	436	#657		95	41
Internal Link Dist (ft)		1131	858		431	
Turn Bay Length (ft)	285				445	
Base Capacity (vph)	416	2622	2121		1100	1827
Starvation Cap Reductn	0	0	0		0	0

Lanes, Volumes, Timings  
 2: McEwen /McEwen & Tower

11/18/2016

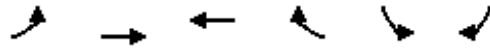

Lane Group	EBL	EBT	WBT	WBR	SBL	SBR
Spillback Cap Reductn	0	0	0		0	0
Storage Cap Reductn	0	0	0		0	0
Reduced v/c Ratio	0.06	0.42	0.55		0.10	0.17

Intersection Summary

Area Type:	CBD
Cycle Length:	105
Actuated Cycle Length:	65.8
Natural Cycle:	105
Control Type:	Actuated-Uncoordinated
Maximum v/c Ratio:	0.68
Intersection Signal Delay:	14.0
Intersection LOS:	B
Intersection Capacity Utilization	57.0%
ICU Level of Service	B
Analysis Period (min)	60
90th %ile Actuated Cycle:	105
70th %ile Actuated Cycle:	74.7
50th %ile Actuated Cycle:	58.7
30th %ile Actuated Cycle:	47.2
10th %ile Actuated Cycle:	43.3
# 95th percentile volume exceeds capacity, queue may be longer. Queue shown is maximum after two cycles.	

Splits and Phases: 2: McEwen /McEwen & Tower

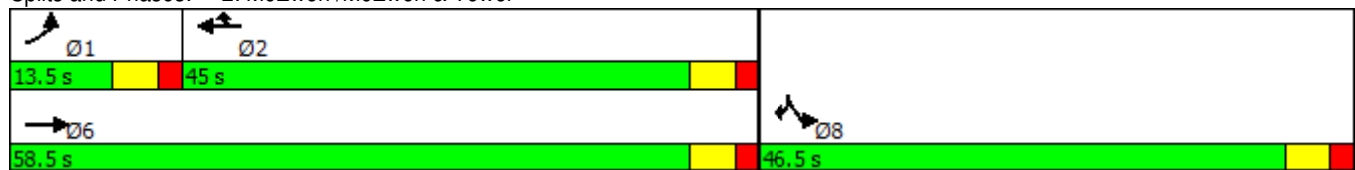

Lanes, Volumes, Timings  
3: Carothers/Carothers & McEwen

11/18/2016



Lane Group	EBL	EBT	EBR	WBL	WBT	WBR	NBL	NBT	NBR	SBL	SBT	SBR
Lane Configurations	↖↖	↗↗	↘	↖↖	↗↗	↘	↖↖	↗↗	↘	↖↖	↗↗	↘
Traffic Volume (vph)	111	620	431	64	277	5	94	172	82	207	1134	749
Future Volume (vph)	111	620	431	64	277	5	94	172	82	207	1134	749
Ideal Flow (vphpl)	1900	1900	1900	1900	1900	1900	1900	1900	1900	1900	1900	1900
Storage Length (ft)	205		205	218		97	300		300	280		310
Storage Lanes	2		1	2		1	2		1	2		1
Taper Length (ft)	25			25			25			25		
Lane Util. Factor	0.97	0.95	1.00	0.97	0.95	1.00	0.97	0.95	1.00	0.97	0.95	1.00
Frt			0.850			0.850			0.850			0.850
Flt Protected	0.950			0.950			0.950			0.950		
Satd. Flow (prot)	3433	3539	1583	3433	3539	1583	3433	3539	1583	3433	3539	1583
Flt Permitted	0.950			0.950			0.950			0.950		
Satd. Flow (perm)	3433	3539	1583	3433	3539	1583	3433	3539	1583	3433	3539	1583
Right Turn on Red			Yes			Yes			Yes			Yes
Satd. Flow (RTOR)			71			71			82			359
Link Speed (mph)		30			30			30				40
Link Distance (ft)		938			1960			1936				857
Travel Time (s)		21.3			44.5			44.0				14.6
Peak Hour Factor	1.00	1.00	1.00	1.00	1.00	1.00	1.00	1.00	1.00	1.00	1.00	1.00
Adj. Flow (vph)	111	620	431	64	277	5	94	172	82	207	1134	749
Shared Lane Traffic (%)												
Lane Group Flow (vph)	111	620	431	64	277	5	94	172	82	207	1134	749
Enter Blocked Intersection	No	No	No	No	No	No	No	No	No	No	No	No
Lane Alignment	Left	Left	Right	Left	Left	Right	Left	Left	Right	Left	Left	Right
Median Width(ft)		24			24			24				24
Link Offset(ft)		0			0			0				0
Crosswalk Width(ft)		16			16			16				16
Two way Left Turn Lane												
Headway Factor	1.00	1.00	1.00	1.00	1.00	1.00	1.00	1.00	1.00	1.00	1.00	1.00
Turning Speed (mph)	15		9	15		9	15		9	15		9
Number of Detectors	1	2	1	1	2	1	1	2	1	1	2	1
Detector Template	Left	Thru	Right	Left	Thru	Right	Left	Thru	Right	Left	Thru	Right
Leading Detector (ft)	20	100	20	20	100	20	20	100	20	20	100	20
Trailing Detector (ft)	0	0	0	0	0	0	0	0	0	0	0	0
Detector 1 Position(ft)	0	0	0	0	0	0	0	0	0	0	0	0
Detector 1 Size(ft)	20	6	20	20	6	20	20	6	20	20	6	20
Detector 1 Type	Cl+Ex	Cl+Ex	Cl+Ex	Cl+Ex	Cl+Ex	Cl+Ex	Cl+Ex	Cl+Ex	Cl+Ex	Cl+Ex	Cl+Ex	Cl+Ex
Detector 1 Channel												
Detector 1 Extend (s)	0.0	0.0	0.0	0.0	0.0	0.0	0.0	0.0	0.0	0.0	0.0	0.0
Detector 1 Queue (s)	0.0	0.0	0.0	0.0	0.0	0.0	0.0	0.0	0.0	0.0	0.0	0.0
Detector 1 Delay (s)	0.0	0.0	0.0	0.0	0.0	0.0	0.0	0.0	0.0	0.0	0.0	0.0
Detector 2 Position(ft)		94			94			94				94
Detector 2 Size(ft)		6			6			6				6
Detector 2 Type		Cl+Ex			Cl+Ex			Cl+Ex				Cl+Ex
Detector 2 Channel												
Detector 2 Extend (s)		0.0			0.0			0.0				0.0
Turn Type	Prot	NA	pm+ov	Prot	NA	pm+ov	Prot	NA	custom	Prot	NA	custom
Protected Phases	1	6	7	5	2	3	7	4	5	3	8	1
Permitted Phases			6			2			8			4

Lanes, Volumes, Timings  
 3: Carothers/Carothers & McEwen

11/18/2016



Lane Group	EBL	EBT	EBR	WBL	WBT	WBR	NBL	NBT	NBR	SBL	SBT	SBR
Detector Phase	1	6	7	5	2	3	7	4	5	3	8	1
Switch Phase												
Minimum Initial (s)	6.0	13.0	6.0	4.0	13.0	6.0	6.0	13.0	4.0	6.0	13.0	6.0
Minimum Split (s)	13.0	52.0	12.5	10.0	52.0	13.0	12.5	52.0	10.0	13.0	52.0	13.0
Total Split (s)	13.0	54.0	12.6	11.0	52.0	13.0	12.6	52.0	11.0	13.0	52.4	13.0
Total Split (%)	10.0%	41.5%	9.7%	8.5%	40.0%	10.0%	9.7%	40.0%	8.5%	10.0%	40.3%	10.0%
Maximum Green (s)	7.0	48.0	6.6	5.5	46.0	7.0	6.6	46.0	5.5	7.0	46.4	7.0
Yellow Time (s)	4.0	4.0	4.0	3.5	4.0	4.0	4.0	4.0	3.5	4.0	4.0	4.0
All-Red Time (s)	2.0	2.0	2.0	2.0	2.0	2.0	2.0	2.0	2.0	2.0	2.0	2.0
Lost Time Adjust (s)	0.0	0.0	0.0	0.0	0.0	0.0	0.0	0.0	0.0	0.0	0.0	0.0
Total Lost Time (s)	6.0	6.0	6.0	5.5	6.0	6.0	6.0	6.0	5.5	6.0	6.0	6.0
Lead/Lag	Lead	Lag	Lead	Lead	Lag	Lead	Lead	Lag	Lead	Lead	Lag	Lead
Lead-Lag Optimize?												
Vehicle Extension (s)	3.0	3.0	3.0	3.0	3.0	3.0	3.0	3.0	3.0	3.0	3.0	3.0
Recall Mode	Max	None	None	None	None	None	None	None	None	None	None	Max
Walk Time (s)		7.0			7.0			7.0			7.0	
Flash Dont Walk (s)		39.0			39.0			37.0			37.0	
Pedestrian Calls (#/hr)		5			5			5			5	
Act Effct Green (s)	7.2	26.9	39.8	5.6	24.9	38.2	6.7	39.1	51.3	7.2	39.5	52.4
Actuated g/C Ratio	0.07	0.26	0.39	0.05	0.24	0.37	0.07	0.38	0.50	0.07	0.38	0.51
v/c Ratio	0.46	0.67	0.66	0.34	0.32	0.01	0.42	0.13	0.10	0.87	0.84	0.76
Control Delay	57.4	37.8	27.1	57.8	32.9	0.0	57.2	22.5	4.4	92.6	36.5	17.3
Queue Delay	0.0	0.0	0.0	0.0	0.0	0.0	0.0	0.0	0.0	0.0	0.0	0.0
Total Delay	57.4	37.8	27.1	57.8	32.9	0.0	57.2	22.5	4.4	92.6	36.5	17.3
LOS	E	D	C	E	C	A	E	C	A	F	D	B
Approach Delay		35.7			37.1			27.6			35.2	
Approach LOS		D			D			C			D	
90th %ile Green (s)	7.0	48.0	6.6	5.5	46.0	7.0	6.6	46.0	5.5	7.0	46.4	7.0
90th %ile Term Code	MaxR	Hold	Max	Max	Ped	Max	Max	Hold	Max	Max	Max	MaxR
70th %ile Green (s)	7.0	27.9	6.6	5.5	25.9	7.0	6.6	46.0	5.5	7.0	46.4	7.0
70th %ile Term Code	MaxR	Gap	Max	Max	Hold	Max	Max	Hold	Max	Max	Max	MaxR
50th %ile Green (s)	7.0	24.4	6.6	5.5	22.4	7.0	6.6	39.8	5.5	7.0	40.2	7.0
50th %ile Term Code	MaxR	Gap	Max	Max	Hold	Max	Max	Hold	Max	Max	Gap	MaxR
30th %ile Green (s)	7.0	22.0	6.6	5.5	20.0	7.0	6.6	35.4	5.5	7.0	35.8	7.0
30th %ile Term Code	MaxR	Gap	Max	Max	Hold	Max	Max	Hold	Max	Max	Gap	MaxR
10th %ile Green (s)	7.0	16.8	6.5	5.5	14.8	7.0	6.5	28.4	5.5	7.0	28.9	7.0
10th %ile Term Code	MaxR	Gap	Gap	Max	Hold	Max	Gap	Hold	Max	Max	Gap	MaxR
Stops (vph)	101	520	284	59	210	0	84	105	9	167	950	342
Fuel Used(gal)	3	12	7	2	7	0	3	4	1	7	24	10
CO Emissions (g/hr)	186	851	496	144	507	5	208	277	95	471	1702	724
NOx Emissions (g/hr)	36	166	97	28	99	1	40	54	18	92	331	141
VOC Emissions (g/hr)	43	197	115	33	117	1	48	64	22	109	395	168
Dilemma Vehicles (#)	0	0	0	0	0	0	0	0	0	0	47	0
Queue Length 50th (ft)	36	191	193	20	78	0	30	35	0	68	329	185
Queue Length 95th (ft)	#98	304	383	58	136	0	#81	88	38	#215	#732	#751
Internal Link Dist (ft)		858			1880			1856			777	
Turn Bay Length (ft)	205		205	218		97	300		300	280		310
Base Capacity (vph)	239	1691	656	188	1621	632	225	1621	830	239	1635	982
Starvation Cap Reductn	0	0	0	0	0	0	0	0	0	0	0	0

Lanes, Volumes, Timings  
 3: Carothers/Carothers & McEwen

11/18/2016

Lane Group	EBL	EBT	EBR	WBL	WBT	WBR	NBL	NBT	NBR	SBL	SBT	SBR
Spillback Cap Reductn	0	0	0	0	0	0	0	0	0	0	0	0
Storage Cap Reductn	0	0	0	0	0	0	0	0	0	0	0	0
Reduced v/c Ratio	0.46	0.37	0.66	0.34	0.17	0.01	0.42	0.11	0.10	0.87	0.69	0.76

Intersection Summary

Area Type:	Other
Cycle Length:	130
Actuated Cycle Length:	102.9
Natural Cycle:	130
Control Type:	Semi Act-Uncoord
Maximum v/c Ratio:	0.87
Intersection Signal Delay:	34.8
Intersection LOS:	C
Intersection Capacity Utilization	77.2%
ICU Level of Service	D
Analysis Period (min)	60
90th %ile Actuated Cycle:	130
70th %ile Actuated Cycle:	109.9
50th %ile Actuated Cycle:	100.2
30th %ile Actuated Cycle:	93.4
10th %ile Actuated Cycle:	81.2
#	95th percentile volume exceeds capacity, queue may be longer. Queue shown is maximum after two cycles.

Splits and Phases: 3: Carothers/Carothers & McEwen

Ø1	Ø2	Ø3	Ø4
13 s	52 s	13 s	52 s
Ø5	Ø6	Ø7	Ø8
11 s	54 s	12.6 s	52.4 s

Lanes, Volumes, Timings  
 4: Ovation/Resource Parkway & McEwen

11/18/2016

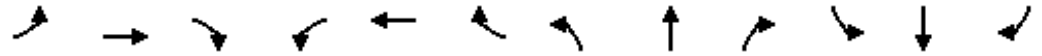

Lane Group	EBL	EBT	EBR	WBL	WBT	WBR	NBL	NBT	NBR	SBL	SBT	SBR
Lane Configurations												
Traffic Volume (vph)	87	815	0	0	363	13	0	0	0	74	0	68
Future Volume (vph)	87	815	0	0	363	13	0	0	0	74	0	68
Ideal Flow (vphpl)	1900	1900	1900	1900	1900	1900	1900	1900	1900	1900	1900	1900
Lane Util. Factor	1.00	0.95	1.00	1.00	0.95	0.95	1.00	1.00	1.00	1.00	1.00	1.00
Fr <sub>t</sub>					0.995							0.850
Fl <sub>t</sub> Protected	0.950									0.950		
Satd. Flow (prot)	1770	3539	0	0	3522	0	0	0	0	1770	0	1583
Fl <sub>t</sub> Permitted	0.950									0.950		
Satd. Flow (perm)	1770	3539	0	0	3522	0	0	0	0	1770	0	1583
Link Speed (mph)		30			30			30			30	
Link Distance (ft)		1960			345			402			456	
Travel Time (s)		44.5			7.8			9.1			10.4	
Peak Hour Factor	1.00	1.00	1.00	1.00	1.00	1.00	1.00	1.00	1.00	1.00	1.00	1.00
Adj. Flow (vph)	87	815	0	0	363	13	0	0	0	74	0	68
Shared Lane Traffic (%)												
Lane Group Flow (vph)	87	815	0	0	376	0	0	0	0	74	0	68
Enter Blocked Intersection	No	No	No	No	No	No	No	No	No	No	No	No
Lane Alignment	Left	Left	Right	Left	Left	Right	Left	Left	Right	Left	Left	Right
Median Width(ft)		36			36			12			12	
Link Offset(ft)		0			0			0			0	
Crosswalk Width(ft)		16			16			16			16	
Two way Left Turn Lane												
Headway Factor	1.00	1.00	1.00	1.00	1.00	1.00	1.00	1.00	1.00	1.00	1.00	1.00
Turning Speed (mph)	15		9	15		9	15		9	15		9
Sign Control		Free			Free			Stop			Stop	

























Intersection Summary

Area Type:	Other
Control Type:	Unsignalized
Intersection Capacity Utilization	33.3%
ICU Level of Service	A
Analysis Period (min)	60



Lanes, Volumes, Timings  
5: Carothers /Carothers & Tower/Pacific

11/18/2016

												
Lane Group	EBL	EBT	EBR	WBL	WBT	WBR	NBL	NBT	NBR	SBL	SBT	SBR
Lane Configurations												
Traffic Volume (vph)	13	1	22	10	0	8	2	267	29	4	1984	9
Future Volume (vph)	13	1	22	10	0	8	2	267	29	4	1984	9
Ideal Flow (vphpl)	1900	1900	1900	1900	1900	1900	1900	1900	1900	1900	1900	1900
Grade (%)		0%			0%			2%			0%	
Storage Length (ft)	84		78	106		77	177		100	85		144
Storage Lanes	2		1	1		1	1		1	1		1
Taper Length (ft)	25			25			25			25		
Lane Util. Factor	0.97	1.00	1.00	1.00	1.00	1.00	1.00	0.95	1.00	1.00	0.95	1.00
Fr <sub>t</sub>			0.850			0.850			0.850			0.850
Fl <sub>t</sub> Protected	0.950			0.950			0.950			0.950		
Satd. Flow (prot)	3433	1863	1583	1770	1863	1583	1752	3504	1567	1770	3539	1583
Fl <sub>t</sub> Permitted	0.950			0.950			0.080			0.587		
Satd. Flow (perm)	3433	1863	1583	1770	1863	1583	148	3504	1567	1093	3539	1583
Right Turn on Red			Yes			Yes			Yes			Yes
Satd. Flow (RTOR)			133			523			128			128
Link Speed (mph)		30			30			40			30	
Link Distance (ft)		881			890			857			905	
Travel Time (s)		20.0			20.2			14.6			20.6	
Peak Hour Factor	1.00	1.00	1.00	1.00	1.00	1.00	1.00	1.00	1.00	1.00	1.00	1.00
Adj. Flow (vph)	13	1	22	10	0	8	2	267	29	4	1984	9
Shared Lane Traffic (%)												
Lane Group Flow (vph)	13	1	22	10	0	8	2	267	29	4	1984	9
Enter Blocked Intersection	No	No	No	No	No	No	No	No	No	No	No	No
Lane Alignment	Left	Left	Right	Left	Left	Right	Left	Left	Right	Left	Left	Right
Median Width(ft)		24			24			24			24	
Link Offset(ft)		0			0			0			0	
Crosswalk Width(ft)		16			16			16			16	
Two way Left Turn Lane												
Headway Factor	1.00	1.00	1.00	1.00	1.00	1.00	1.01	1.01	1.01	1.00	1.00	1.00
Turning Speed (mph)	15		9	15		9	15		9	15		9
Number of Detectors	1	2	1	1	2	1	1	2	1	1	2	1
Detector Template	Left	Thru	Right	Left	Thru	Right	Left	Thru	Right	Left	Thru	Right
Leading Detector (ft)	20	100	20	20	100	20	20	100	20	20	100	20
Trailing Detector (ft)	0	0	0	0	0	0	0	0	0	0	0	0
Detector 1 Position(ft)	0	0	0	0	0	0	0	0	0	0	0	0
Detector 1 Size(ft)	20	6	20	20	6	20	20	6	20	20	6	20
Detector 1 Type	Cl+Ex	Cl+Ex	Cl+Ex	Cl+Ex	Cl+Ex	Cl+Ex	Cl+Ex	Cl+Ex	Cl+Ex	Cl+Ex	Cl+Ex	Cl+Ex
Detector 1 Channel												
Detector 1 Extend (s)	0.0	0.0	0.0	0.0	0.0	0.0	0.0	0.0	0.0	0.0	0.0	0.0
Detector 1 Queue (s)	0.0	0.0	0.0	0.0	0.0	0.0	0.0	0.0	0.0	0.0	0.0	0.0
Detector 1 Delay (s)	0.0	0.0	0.0	0.0	0.0	0.0	0.0	0.0	0.0	0.0	0.0	0.0
Detector 2 Position(ft)		94			94			94			94	
Detector 2 Size(ft)		6			6			6			6	
Detector 2 Type		Cl+Ex			Cl+Ex			Cl+Ex			Cl+Ex	
Detector 2 Channel												
Detector 2 Extend (s)		0.0			0.0			0.0			0.0	
Turn Type	Prot	NA	Perm	Prot		Perm	pm+pt	NA	Perm	pm+pt	NA	Perm
Protected Phases	3	8		7	4		1	6		5	2	

Lanes, Volumes, Timings  
5: Carothers /Carothers & Tower/Pacific

11/18/2016



Lane Group	EBL	EBT	EBR	WBL	WBT	WBR	NBL	NBT	NBR	SBL	SBT	SBR
Permitted Phases			8			4	6		6	2		2
Detector Phase	3	8	8	7	4	4	1	6	6	5	2	2
Switch Phase												
Minimum Initial (s)	6.0	8.0	8.0	6.0	8.0	8.0	6.0	20.0	20.0	6.0	20.0	20.0
Minimum Split (s)	12.5	48.5	48.5	12.5	48.5	48.5	12.0	42.0	42.0	12.0	42.0	42.0
Total Split (s)	12.5	48.5	48.5	12.5	48.5	48.5	12.0	42.0	42.0	12.0	42.0	42.0
Total Split (%)	10.9%	42.2%	42.2%	10.9%	42.2%	42.2%	10.4%	36.5%	36.5%	10.4%	36.5%	36.5%
Maximum Green (s)	7.0	43.0	43.0	7.0	43.0	43.0	6.5	36.0	36.0	6.5	36.0	36.0
Yellow Time (s)	3.5	3.5	3.5	3.5	3.5	3.5	3.5	4.0	4.0	3.5	4.0	4.0
All-Red Time (s)	2.0	2.0	2.0	2.0	2.0	2.0	2.0	2.0	2.0	2.0	2.0	2.0
Lost Time Adjust (s)	0.0	0.0	0.0	0.0	0.0	0.0	0.0	0.0	0.0	0.0	0.0	0.0
Total Lost Time (s)	5.5	5.5	5.5	5.5	5.5	5.5	5.5	6.0	6.0	5.5	6.0	6.0
Lead/Lag	Lead	Lag	Lag	Lead	Lag	Lag	Lead	Lag	Lag	Lead	Lag	Lag
Lead-Lag Optimize?												
Vehicle Extension (s)	3.0	3.0	3.0	3.0	3.0	3.0	3.0	3.0	3.0	3.0	3.0	3.0
Recall Mode	None	None	None	None	None	None	None	Min	Min	None	Min	Min
Walk Time (s)		7.0	7.0		7.0	7.0		7.0	7.0		7.0	7.0
Flash Dont Walk (s)		36.0	36.0		36.0	36.0		29.0	29.0		29.0	29.0
Pedestrian Calls (#/hr)		10	10		10	10		10	10		10	10
Act Effct Green (s)	6.6	12.8	12.8	6.6		12.9	51.0	54.1	54.1	51.0	54.1	54.1
Actuated g/C Ratio	0.10	0.19	0.19	0.10		0.19	0.75	0.79	0.79	0.75	0.79	0.79
v/c Ratio	0.04	0.00	0.05	0.06		0.01	0.01	0.10	0.02	0.00	0.71	0.01
Control Delay	36.8	22.0	0.3	37.6		0.0	12.0	10.1	0.0	11.5	15.3	0.0
Queue Delay	0.0	0.0	0.0	0.0		0.0	0.0	0.0	0.0	0.0	0.0	0.0
Total Delay	36.8	22.0	0.3	37.6		0.0	12.0	10.1	0.0	11.5	15.3	0.0
LOS	D	C	A	D		A	B	B	A	B	B	A
Approach Delay		14.1						9.1			15.2	
Approach LOS		B						A			B	
90th %ile Green (s)	6.7	43.0	43.0	7.0	43.3	43.3	6.0	36.0	36.0	6.1	36.1	36.1
90th %ile Term Code	Gap	Ped	Ped	Max	Hold	Hold	Min	Ped	Ped	Gap	Hold	Hold
70th %ile Green (s)	0.0	8.0	8.0	0.0	8.0	8.0	0.0	36.0	36.0	0.0	36.0	36.0
70th %ile Term Code	Skip	Min	Min	Skip	Hold	Hold	Skip	Hold	Hold	Skip	Max	Max
50th %ile Green (s)	0.0	0.0	0.0	0.0	0.0	0.0	0.0	51.0	51.0	0.0	51.0	51.0
50th %ile Term Code	Skip	Skip	Skip	Skip	Skip	Skip	Skip	Dwell	Dwell	Skip	Dwell	Dwell
30th %ile Green (s)	0.0	0.0	0.0	0.0	0.0	0.0	0.0	51.0	51.0	0.0	51.0	51.0
30th %ile Term Code	Skip	Skip	Skip	Skip	Skip	Skip	Skip	Dwell	Dwell	Skip	Dwell	Dwell
10th %ile Green (s)	0.0	0.0	0.0	0.0	0.0	0.0	0.0	51.0	51.0	0.0	51.0	51.0
10th %ile Term Code	Skip	Skip	Skip	Skip	Skip	Skip	Skip	Dwell	Dwell	Skip	Dwell	Dwell
Stops (vph)	14	2	0	12		0	1	79	0	3	554	0
Fuel Used(gal)	0	0	0	0		0	0	3	0	0	23	0
CO Emissions (g/hr)	18	2	11	15		4	2	201	12	4	1624	4
NOx Emissions (g/hr)	4	0	2	3		1	0	39	2	1	316	1
VOC Emissions (g/hr)	4	0	2	3		1	0	47	3	1	376	1
Dilemma Vehicles (#)	0	0	0	0		0	0	8	0	0	0	0
Queue Length 50th (ft)	2	0	0	3		0	0	0	0	0	0	0
Queue Length 95th (ft)	17	5	0	28		0	6	125	0	9	#1486	0
Internal Link Dist (ft)		801			810			777			825	
Turn Bay Length (ft)	84		78	106		77	177		100	85		144
Base Capacity (vph)	381	1271	1122	196		1247	276	2777	1268	888	2805	1281

Lanes, Volumes, Timings  
 5: Carothers /Carothers & Tower/Pacific

11/18/2016



Lane Group	EBL	EBT	EBR	WBL	WBT	WBR	NBL	NBT	NBR	SBL	SBT	SBR
Starvation Cap Reductn	0	0	0	0		0	0	0	0	0	0	0
Spillback Cap Reductn	0	0	0	0		0	0	0	0	0	0	0
Storage Cap Reductn	0	0	0	0		0	0	0	0	0	0	0
Reduced v/c Ratio	0.03	0.00	0.02	0.05		0.01	0.01	0.10	0.02	0.00	0.71	0.01

Intersection Summary

Area Type:	Other
Cycle Length:	115
Actuated Cycle Length:	68.2
Natural Cycle:	115
Control Type:	Actuated-Uncoordinated
Maximum v/c Ratio:	0.71
Intersection Signal Delay:	14.4
Intersection LOS:	B
Intersection Capacity Utilization:	80.7%
ICU Level of Service:	D
Analysis Period (min):	60
90th %ile Actuated Cycle:	114.6
70th %ile Actuated Cycle:	55.5
50th %ile Actuated Cycle:	57
30th %ile Actuated Cycle:	57
10th %ile Actuated Cycle:	57
# 95th percentile volume exceeds capacity, queue may be longer. Queue shown is maximum after two cycles.	

Splits and Phases: 5: Carothers /Carothers & Tower/Pacific

Ø1	Ø2	Ø3	Ø4
12 s	42 s	12.5 s	48.5 s
Ø5	Ø6	Ø7	Ø8
12 s	42 s	12.5 s	48.5 s

Lanes, Volumes, Timings  
 6: Carothers/Carothers Parkway & Apartments/Resource

11/18/2016

Lane Group	EBL	EBT	EBR	WBL	WBT	WBR	NBL	NBT	NBR	SBL	SBT	SBR
Lane Configurations												
Traffic Volume (vph)	0	0	3	8	0	17	3	312	3	64	1951	0
Future Volume (vph)	0	0	3	8	0	17	3	312	3	64	1951	0
Ideal Flow (vphpl)	1900	1900	1900	1900	1900	1900	1900	1900	1900	1900	1900	1900
Grade (%)		0%			0%			2%			0%	
Storage Length (ft)	0		0	0		0	210		128	480		93
Storage Lanes	1		0	1		1	1		0	1		1
Taper Length (ft)	25			25			25			25		
Lane Util. Factor	1.00	1.00	1.00	1.00	1.00	1.00	1.00	0.95	0.95	1.00	0.95	1.00
Frt		0.850				0.850		0.999				
Flt Protected				0.950			0.950			0.950		
Satd. Flow (prot)	1863	1583	0	1770	1863	1583	1752	3500	0	1770	3539	1863
Flt Permitted				0.950			0.950			0.950		
Satd. Flow (perm)	1863	1583	0	1770	1863	1583	1752	3500	0	1770	3539	1863
Link Speed (mph)		30			30			40			40	
Link Distance (ft)		762			773			905			2004	
Travel Time (s)		17.3			17.6			15.4			34.2	
Peak Hour Factor	1.00	1.00	1.00	1.00	1.00	1.00	1.00	1.00	1.00	1.00	1.00	1.00
Adj. Flow (vph)	0	0	3	8	0	17	3	312	3	64	1951	0
Shared Lane Traffic (%)												
Lane Group Flow (vph)	0	3	0	8	0	17	3	315	0	64	1951	0
Enter Blocked Intersection	No	No	No	No	No	No	No	No	No	No	No	No
Lane Alignment	Left	Left	Right	Left	Left	Right	Left	Left	Right	Left	Left	Right
Median Width(ft)		12			12			12			12	
Link Offset(ft)		0			0			0			0	
Crosswalk Width(ft)		16			16			16			16	
Two way Left Turn Lane												
Headway Factor	1.00	1.00	1.00	1.00	1.00	1.00	1.01	1.01	1.01	1.00	1.00	1.00
Turning Speed (mph)	15		9	15		9	15		9	15		9
Sign Control		Stop			Stop			Free			Free	

Intersection Summary	
Area Type:	Other
Control Type:	Unsignalized
Intersection Capacity Utilization	67.2%
Analysis Period (min)	60
	ICU Level of Service C

# HCS 2010 Two-Way Stop Control Summary Report

General Information		Site Information	
Analyst	FTG	Intersection	E. McEwen and Resource
Agency/Co.	FTG	Jurisdiction	Franklin, TN
Date Performed	Nov 2016	East/West Street	E. McEwen Drive
Analysis Year	2016	North/South Street	Resource Drive
Time Analyzed	AM Peak Hour	Peak Hour Factor	0.92
Intersection Orientation	East-West	Analysis Time Period (hrs)	0.25
Project Description	10765		

## Lanes

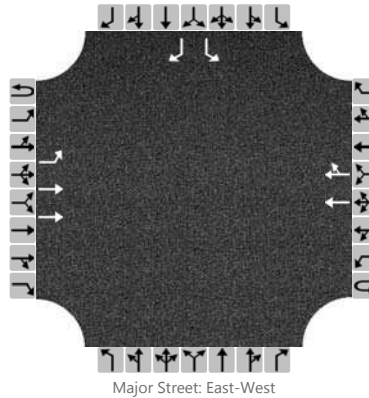

## Vehicle Volumes and Adjustments

Approach	Eastbound				Westbound				Northbound				Southbound			
	U	L	T	R	U	L	T	R	U	L	T	R	U	L	T	R
Movement	1U	1	2	3	4U	4	5	6		7	8	9		10	11	12
Priority																
Number of Lanes	0	1	2	0	0	0	2	0		0	0	0		1	0	1
Configuration		L	T				T	TR						L		R
Volume (veh/h)		62	215				936	42						18		98
Percent Heavy Vehicles		0												0		0
Proportion Time Blocked																
Right Turn Channelized	No				No				No				No			
Median Type	Left Only															
Median Storage	1															

## Delay, Queue Length, and Level of Service

Flow Rate (veh/h)		67												20		107	
Capacity		663												228		497	
v/c Ratio		0.10												0.09		0.22	
95% Queue Length		0.3												0.3		0.8	
Control Delay (s/veh)		11.0												22.3		14.2	
Level of Service (LOS)		B												C		B	
Approach Delay (s/veh)		2.5												15.5			
Approach LOS		A												C			

# HCS 2010 Two-Way Stop Control Summary Report

General Information		Site Information	
Analyst	FTG	Intersection	E. McEwen and Resource
Agency/Co.	FTG	Jurisdiction	Franklin, TN
Date Performed	Nov 2016	East/West Street	E. McEwen Drive
Analysis Year	2016	North/South Street	Resource Drive
Time Analyzed	PM Peak Hour	Peak Hour Factor	0.92
Intersection Orientation	East-West	Analysis Time Period (hrs)	0.25
Project Description	10765		

## Lanes

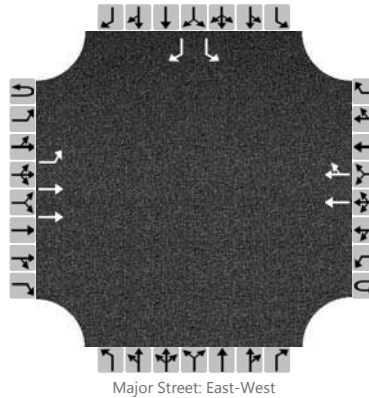

## Vehicle Volumes and Adjustments

Approach	Eastbound				Westbound				Northbound				Southbound			
	U	L	T	R	U	L	T	R	U	L	T	R	U	L	T	R
Movement	1U	1	2	3	4U	4	5	6		7	8	9		10	11	12
Priority																
Number of Lanes	0	1	2	0	0	0	2	0		0	0	0		1	0	1
Configuration		L	T				T	TR						L		R
Volume (veh/h)		87	815				363	13						74		68
Percent Heavy Vehicles		0												0		0
Proportion Time Blocked																
Right Turn Channelized	No				No				No				No			
Median Type	Left Only															
Median Storage	1															

## Delay, Queue Length, and Level of Service

Flow Rate (veh/h)		95												80		74	
Capacity		1161												310		809	
v/c Ratio		0.08												0.26		0.09	
95% Queue Length		0.3												1.0		0.3	
Control Delay (s/veh)		8.4												20.6		9.9	
Level of Service (LOS)		A												C		A	
Approach Delay (s/veh)		0.8												15.5			
Approach LOS		A												C			



# HCS 2010 Two-Way Stop Control Summary Report

General Information		Site Information	
Analyst	FTG	Intersection	Carothers and Resource
Agency/Co.	FTG	Jurisdiction	Franklin, TN
Date Performed	Nov 2016	East/West Street	Resource Drive
Analysis Year	2016	North/South Street	Carothers Parkway
Time Analyzed	AM Peak Hour	Peak Hour Factor	0.92
Intersection Orientation	North-South	Analysis Time Period (hrs)	0.25
Project Description	10765		

## Lanes

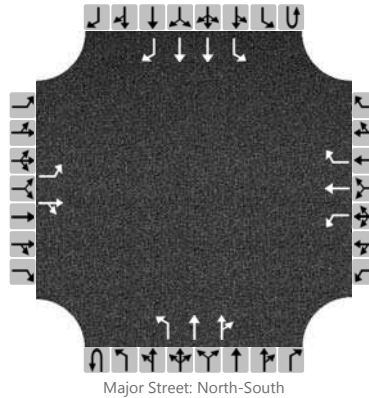

## Vehicle Volumes and Adjustments

Approach	Eastbound				Westbound				Northbound				Southbound			
	U	L	T	R	U	L	T	R	U	L	T	R	U	L	T	R
Movement																
Priority		10	11	12		7	8	9	1U	1	2	3	4U	4	5	6
Number of Lanes		1	1	0		1	1	1	0	1	2	0	0	1	2	1
Configuration		L		TR		L	T	R		L	T	TR		L	T	R
Volume (veh/h)		1	0	2		9	0	63		2	1938	1		7	213	2
Percent Heavy Vehicles		0	0	0		0	0	0		0				0		
Proportion Time Blocked																
Right Turn Channelized	No				No				No				No			
Median Type	Left Only															
Median Storage	1															

## Delay, Queue Length, and Level of Service

Flow Rate (veh/h)		1	2		10		68		2					8		
Capacity		140	921		48	1668	226		1345					264		
v/c Ratio		0.01	0.00		0.21		0.30		0.00					0.03		
95% Queue Length		0.0	0.0		0.7		1.2		0.0					0.1		
Control Delay (s/veh)		31.0	8.9		99.3	7.2	27.7		7.7					19.1		
Level of Service (LOS)		D	A		F	A	D		A					C		
Approach Delay (s/veh)	16.3				36.9				0.0				0.6			
Approach LOS	C				E				A				A			

# HCS 2010 Two-Way Stop Control Summary Report

General Information				Site Information			
Analyst	FTG			Intersection	Carothers and Resource		
Agency/Co.	FTG			Jurisdiction	Franklin, TN		
Date Performed	Nov 2016			East/West Street	Resource Drive		
Analysis Year	2016			North/South Street	Carothers Parkway		
Time Analyzed	PM Peak Hour			Peak Hour Factor	0.92		
Intersection Orientation	North-South			Analysis Time Period (hrs)	0.25		
Project Description	10765						

## Lanes

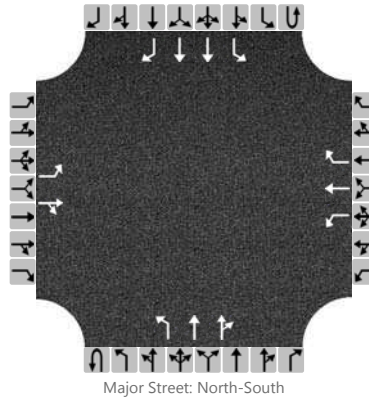

## Vehicle Volumes and Adjustments

Approach	Eastbound				Westbound				Northbound				Southbound			
	U	L	T	R	U	L	T	R	U	L	T	R	U	L	T	R
Movement																
Priority		10	11	12		7	8	9	1U	1	2	3	4U	4	5	6
Number of Lanes		1	1	0		1	1	1	0	1	2	0	0	1	2	1
Configuration		L		TR		L	T	R		L	T	TR		L	T	R
Volume (veh/h)		0	0	3		8	0	17		3	312	3		64	1951	0
Percent Heavy Vehicles		0	0	0		0	0	0		0				0		
Proportion Time Blocked																
Right Turn Channelized	No				No				No				No			
Median Type	Left Only															
Median Storage	1															

## Delay, Queue Length, and Level of Service

Flow Rate (veh/h)				3				9				18				3				70
Capacity		36		224		151	807	849		261				1228						
v/c Ratio				0.01		0.06		0.02		0.01				0.06						
95% Queue Length				0.0		0.2		0.1		0.0				0.2						
Control Delay (s/veh)		104.5		21.3		30.4	9.5	9.3		19.0				8.1						
Level of Service (LOS)		F		C		D	A	A		C				A						
Approach Delay (s/veh)	21.3				16.3				0.2				0.3							
Approach LOS	C				C				A				A							

# HCS 2010 Two-Way Stop Control Summary Report

General Information		Site Information	
Analyst	FTG	Intersection	Resource and Pacific
Agency/Co.	FTG	Jurisdiction	Franklin, TN
Date Performed	Nov	East/West Street	Pacific Drive
Analysis Year	2016	North/South Street	Resource Drive
Time Analyzed	AM Peak Hour	Peak Hour Factor	0.92
Intersection Orientation	North-South	Analysis Time Period (hrs)	0.25
Project Description	10765 (Existing)		

## Lanes

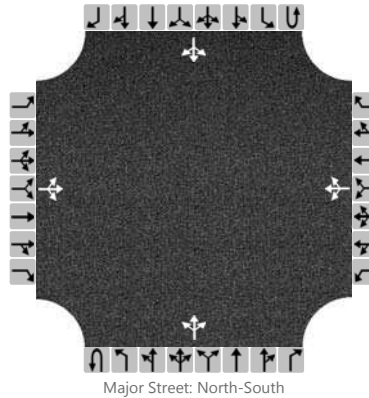

## Vehicle Volumes and Adjustments

Approach	Eastbound				Westbound				Northbound				Southbound			
	U	L	T	R	U	L	T	R	U	L	T	R	U	L	T	R
Movement																
Priority		10	11	12		7	8	9	1U	1	2	3	4U	4	5	6
Number of Lanes		0	1	0		0	1	0	0	0	1	0	0	0	1	0
Configuration			LTR				LTR				LTR				LTR	
Volume (veh/h)		2	4	3		5	11	10		21	28	0		1	3	11
Percent Heavy Vehicles		0	0	0		0	0	0		0				0		
Proportion Time Blocked																
Right Turn Channelized	No				No				No				No			
Median Type	Undivided															
Median Storage																

## Delay, Queue Length, and Level of Service

Flow Rate (veh/h)			9				28					23				1		
Capacity			888				893					1616				1596		
v/c Ratio			0.01				0.03					0.01				0.00		
95% Queue Length			0.0				0.1					0.0				0.0		
Control Delay (s/veh)			9.1				9.2					7.3				7.3		
Level of Service (LOS)			A				A					A				A		
Approach Delay (s/veh)	9.1				9.2				3.2				0.5					
Approach LOS	A				A				A				A					

# HCS 2010 Two-Way Stop Control Summary Report

General Information		Site Information	
Analyst	FTG	Intersection	Resource and Pacific
Agency/Co.	FTG	Jurisdiction	Franklin, TN
Date Performed	Nov	East/West Street	Pacific Drive
Analysis Year	2016	North/South Street	Resource Drive
Time Analyzed	PM Peak Hour	Peak Hour Factor	0.92
Intersection Orientation	North-South	Analysis Time Period (hrs)	0.25
Project Description	10765 (Existing)		

## Lanes

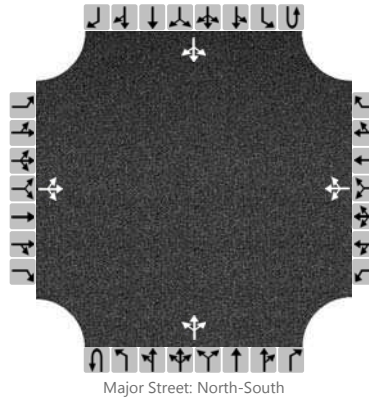

## Vehicle Volumes and Adjustments

Approach	Eastbound				Westbound				Northbound				Southbound			
	U	L	T	R	U	L	T	R	U	L	T	R	U	L	T	R
Movement																
Priority		10	11	12		7	8	9	1U	1	2	3	4U	4	5	6
Number of Lanes		0	1	0		0	1	0	0	0	1	0	0	0	1	0
Configuration			LTR				LTR				LTR				LTR	
Volume (veh/h)		4	4	26		6	4	1		9	10	1		12	26	5
Percent Heavy Vehicles		0	0	0		0	0	0		0				0		
Proportion Time Blocked																
Right Turn Channelized	No				No				No				No			
Median Type	Undivided															
Median Storage																

## Delay, Queue Length, and Level of Service

Flow Rate (veh/h)			36				12				10				13		
Capacity			994				841				1592				1620		
v/c Ratio			0.04				0.01				0.01				0.01		
95% Queue Length			0.1				0.0				0.0				0.0		
Control Delay (s/veh)			8.8				9.3				7.3				7.2		
Level of Service (LOS)			A				A				A				A		
Approach Delay (s/veh)	8.8				9.3				3.3				2.1				
Approach LOS	A				A				A				A				

# HCS 2010 Two-Way Stop Control Summary Report

General Information		Site Information	
Analyst	FTG	Intersection	Resource and Terrapin
Agency/Co.	FTG	Jurisdiction	Franklin, TN
Date Performed	Nov	East/West Street	Terrapin St
Analysis Year	2016	North/South Street	Resource Drive
Time Analyzed	AM Peak Hour	Peak Hour Factor	0.92
Intersection Orientation	North-South	Analysis Time Period (hrs)	0.25
Project Description	10765 (Existing)		

## Lanes

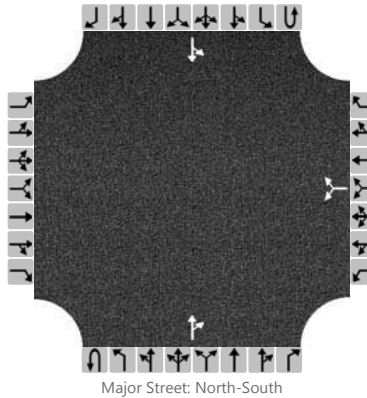

## Vehicle Volumes and Adjustments

Approach	Eastbound				Westbound				Northbound				Southbound			
	U	L	T	R	U	L	T	R	U	L	T	R	U	L	T	R
Movement																
Priority		10	11	12		7	8	9	1U	1	2	3	4U	4	5	6
Number of Lanes		0	0	0		0	0	0	0	0	1	0	0	0	1	0
Configuration							LR					TR		LT		
Volume (veh/h)						9		20			29	2		2	9	
Percent Heavy Vehicles						0		0						0		
Proportion Time Blocked																
Right Turn Channelized	No				No				No				No			
Median Type	Undivided															
Median Storage																

## Delay, Queue Length, and Level of Service

Flow Rate (veh/h)							32								12		
Capacity							1017								1591		
v/c Ratio							0.03								0.01		
95% Queue Length							0.1								0.0		
Control Delay (s/veh)							8.7								7.3		
Level of Service (LOS)							A								A		
Approach Delay (s/veh)					8.7								1.2				
Approach LOS					A								A				

# HCS 2010 Two-Way Stop Control Summary Report

General Information		Site Information	
Analyst	FTG	Intersection	Resource and Terrapin
Agency/Co.	FTG	Jurisdiction	Franklin, TN
Date Performed	Nov	East/West Street	Terrapin St
Analysis Year	2016	North/South Street	Resource Drive
Time Analyzed	PM Peak Hour	Peak Hour Factor	0.92
Intersection Orientation	North-South	Analysis Time Period (hrs)	0.25
Project Description	10765 (Existing)		

## Lanes

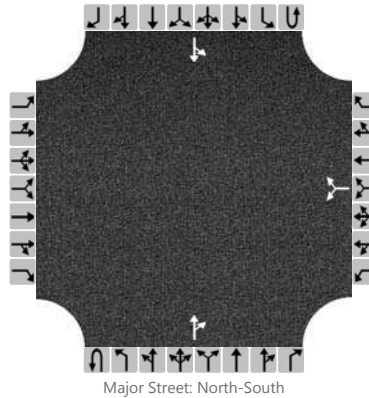

## Vehicle Volumes and Adjustments

Approach	Eastbound				Westbound				Northbound				Southbound			
	U	L	T	R	U	L	T	R	U	L	T	R	U	L	T	R
Movement																
Priority		10	11	12		7	8	9	1U	1	2	3	4U	4	5	6
Number of Lanes		0	0	0		0	0	0	0	0	1	0	0	0	1	0
Configuration							LR					TR		LT		
Volume (veh/h)						7		6			14	6		13	45	
Percent Heavy Vehicles						0		0						0		
Proportion Time Blocked																
Right Turn Channelized	No				No				No				No			
Median Type	Undivided															
Median Storage																

## Delay, Queue Length, and Level of Service

Flow Rate (veh/h)							15								63	
Capacity							962								1607	
v/c Ratio							0.02								0.04	
95% Queue Length							0.0								0.0	
Control Delay (s/veh)							8.8								7.3	
Level of Service (LOS)							A								A	
Approach Delay (s/veh)					8.8								1.7			
Approach LOS					A								A			



Phone:  
E-Mail:

Fax:

-----                    ROUNDBABOUT ANALYSIS                    -----

Analyst: FTG  
 Agency/Co.: FTG  
 Date Performed: Nov 2016  
 Analysis Time Period: AM Peak Hour  
 Intersection: Resource and Lemon Grass  
 Jurisdiction: Franklin, TN  
 Units: U. S. Customary  
 Analysis Year: 2016 (Existing)  
 Project ID: 10765  
 East/West Street: Resource Drive  
 North/South Street: Lemon Grass Drive

-----                    Volume Adjustments and Site Characteristics                    -----

	Eastbound			Westbound			Northbound			Southbound		
	L	T	R	L	T	R	L	T	R	L	T	R
Volume	0	18			20	80				12		11
U-Turn Vol	0			0			0			0		
% Thrus Left Lane	Eastbound			Westbound			Northbound			Southbound		
Lane Assn.	Left Right BP			Left Right BP			Left Right BP			Left Right BP		
RT Bypass	LT			TR			LR			LR		
PHF	0.92	0.92	0.92	0.92	0.92	0.92	0.92	0.92	0.92	0.92	0.92	0.92
%HV	0	0	0	0	0	0	0	0	0	0	0	0
NumPeds	0			0			0			0		
U-Turn PHF	1.00			1.00			1.00			1.00		
U-Turn %HV	3			3			3			3		
Flow Rate	0	20	0	0	22	87	0	0	0	13	0	12
No. Lanes	0	1	0	0	1	0	0	0	0	0	0	0
Cnfl. Lanes	1			1			1			1		
Duration, T	0.25 hrs.											

-----                    Critical and Follow-Up Headway Adjustment                    -----

Crit. Hdwy	5.1929	Eastbound			Westbound			Northbound			Southbound		
		5.1929	5.1929	5.1929	5.1929	5.1929	5.1929	5.1929	5.1929	5.1929	5.1929	5.1929	
Crit. Hdwy	5.1929	Northbound			Southbound			Northbound			Southbound		
		5.1929	5.1929	5.1929	5.1929	5.1929	5.1929	5.1929	5.1929	5.1929	5.1929	5.1929	
Flup. Hdwy	3.1858	Eastbound			Westbound			Northbound			Southbound		
		3.1858	3.1858	2.6087	3.1858	3.1858	2.6087	3.1858	3.1858	2.6087	3.1858	2.6087	
Flup. Hdwy	3.1858	Northbound			Southbound			Northbound			Southbound		
		3.1858	3.1858	2.6087	3.1858	3.1858	2.6087	3.1858	3.1858	2.6087	3.1858	2.6087	

-----                    Flow Computations                    -----

	Eastbound	Westbound	Northbound	Southbound
Circ. Flow	13	0	33	22
Exit. Flow	33	34	87	0

-----                    Capacity and Level of Service                    -----

Eastbound                      Westbound                      Northbound                      Southbound

	Left	Right	BP	Left	Right	BP	Left	Right	BP	Left	Right	BP
Entry Flow		20			109			0			25	
Entry Cap.		1115			1130			0			1106	
Volume (vph)		20			109						25	
Cap. (vph)		1115			1130			0			1106	
v/c Ratio		0.02			0.10						0.02	
Critical Lane		*			*						*	
Lane Delay		3.4			4.0						3.4	
Lane LOS		A			A			F			A	
95 % Queue		0.1			0.3						0.1	
Approach:												
Delay		3.38			4.01						3.44	
LOS		A			A						A	
Intersection Delay		3.83						Intersection LOS			A	

---

Phone:  
E-Mail:

Fax:

-----ROUNDBABOUT ANALYSIS-----

Analyst: FTG  
 Agency/Co.: FTG  
 Date Performed: Nov 2016  
 Analysis Time Period: PM Peak Hour  
 Intersection: Resource and Lemon Grass  
 Jurisdiction: Franklin, TN  
 Units: U. S. Customary  
 Analysis Year: 2016 (Existing)  
 Project ID: 10765  
 East/West Street: Resource Drive  
 North/South Street: Lemon Grass Drive

-----Volume Adjustments and Site Characteristics-----

	Eastbound			Westbound			Northbound			Southbound		
	L	T	R	L	T	R	L	T	R	L	T	R
Volume	13	39			10	22				90		10
U-Turn Vol	0			0			0			0		
% Thrus Left Lane	Eastbound			Westbound			Northbound			Southbound		
Lane Assn.	Left Right BP			Left Right BP			Left Right BP			Left Right BP		
RT Bypass	LT			TR			LR			LR		
PHF	0.92	0.92	0.92	0.92	0.92	0.92	0.92	0.92	0.92	0.92	0.92	0.92
%HV	0	0	0	0	0	0	0	0	0	0	0	0
NumPeds	0			0			0			0		
U-Turn PHF	1.00			1.00			1.00			1.00		
U-Turn %HV	3			3			3			3		
Flow Rate	14	42	0	0	11	24	0	0	0	98	0	11
No. Lanes	0	1	0	0	1	0	0	0	0	0	0	0
Cnfl. Lanes	1			1			1			1		
Duration, T	0.25 hrs.											

-----Critical and Follow-Up Headway Adjustment-----

Crit. Hdwy	5.1929	Eastbound			Westbound			Northbound			Southbound		
		5.1929	5.1929	5.1929	5.1929	5.1929	5.1929	5.1929	5.1929	5.1929	5.1929	5.1929	
Crit. Hdwy	5.1929	Northbound			Southbound			Northbound			Southbound		
		5.1929	5.1929	5.1929	5.1929	5.1929	5.1929	5.1929	5.1929	5.1929	5.1929	5.1929	
Flup. Hdwy	3.1858	Eastbound			Westbound			Northbound			Southbound		
		3.1858	3.1858	2.6087	3.1858	3.1858	2.6087	3.1858	3.1858	2.6087	3.1858	2.6087	
Flup. Hdwy	3.1858	Northbound			Southbound			Northbound			Southbound		
		3.1858	3.1858	2.6087	3.1858	3.1858	2.6087	3.1858	3.1858	2.6087	3.1858	2.6087	

-----Flow Computations-----

	Eastbound	Westbound	Northbound	Southbound
Circ. Flow	98	14	154	11
Exit. Flow	140	22	38	0

-----Capacity and Level of Service-----

Eastbound                      Westbound                      Northbound                      Southbound

	Left	Right	BP	Left	Right	BP	Left	Right	BP	Left	Right	BP
Entry Flow		57			35			0			109	
Entry Cap.		1025			1114			0			1118	
Volume (vph)		57			35						109	
Cap. (vph)		1025			1114			0			1118	
v/c Ratio		0.06			0.03						0.10	
Critical Lane		*			*						*	
Lane Delay		4.0			3.5						4.1	
Lane LOS		A			A			F			A	
95 % Queue		0.2			0.1						0.3	
Approach:												
Delay		4.00			3.49						4.06	
LOS		A			A						A	
Intersection Delay		3.94						Intersection LOS			A	

---

## **BACKGROUND CONDITIONS**

Lanes, Volumes, Timings

1: I65 NB off Ramp /I65 SB off ramp & McEwen/McEwen

11/18/2016

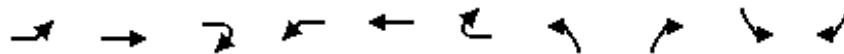

Lane Group	EBL	EBT	EBR2	WBL	WBT	WBR2	NBL	NBR2	SBL	SBR2
Lane Configurations										
Traffic Volume (vph)	480	804	117	164	686	437	614	937	684	372
Future Volume (vph)	480	804	117	164	686	437	614	937	684	372
Ideal Flow (vphpl)	1900	1900	1900	1900	1900	1900	1900	1900	1900	1900
Storage Length (ft)	370			495			0		0	
Storage Lanes	2			1			2		2	
Taper Length (ft)	25			25			25		25	
Lane Util. Factor	0.97	0.95	1.00	1.00	0.95	1.00	0.97	1.00	0.97	0.88
Frt			0.850			0.850		0.850		0.850
Flt Protected	0.950			0.950			0.950		0.950	
Satd. Flow (prot)	3433	3539	1583	1770	3539	1583	3433	1583	3433	2787
Flt Permitted	0.950			0.950			0.950		0.950	
Satd. Flow (perm)	3433	3539	1583	1770	3539	1583	3433	1583	3433	2787
Right Turn on Red			Yes			Yes		Yes		Yes
Satd. Flow (RTOR)			182			437		287		122
Link Speed (mph)		30			30					
Link Distance (ft)		826			1211					
Travel Time (s)		18.8			27.5					
Peak Hour Factor	1.00	1.00	1.00	1.00	1.00	1.00	1.00	1.00	1.00	1.00
Adj. Flow (vph)	480	804	117	164	686	437	614	937	684	372
Shared Lane Traffic (%)										
Lane Group Flow (vph)	480	804	117	164	686	437	614	937	684	372
Enter Blocked Intersection	No	No	No	No	No	No	No	No	No	No
Lane Alignment	Left	Left	Right	Left	Left	Right	Left	Right	Left	Right
Median Width(ft)		24			24					
Link Offset(ft)		0			0					
Crosswalk Width(ft)		16			16					
Two way Left Turn Lane										
Headway Factor	1.00	1.00	1.00	1.00	1.00	1.00	1.00	1.00	1.00	1.00
Turning Speed (mph)	15		9	15		9	15	9	15	9
Number of Detectors	1	2	1	1	2	1	1	1	1	1
Detector Template	Left	Thru	Right	Left	Thru	Right	Left	Right	Left	Right
Leading Detector (ft)	20	100	20	20	100	20	20	20	20	20
Trailing Detector (ft)	0	0	0	0	0	0	0	0	0	0
Detector 1 Position(ft)	0	0	0	0	0	0	0	0	0	0
Detector 1 Size(ft)	20	6	20	20	6	20	20	20	20	20
Detector 1 Type	Cl+Ex	Cl+Ex	Cl+Ex	Cl+Ex	Cl+Ex	Cl+Ex	Cl+Ex	Cl+Ex	Cl+Ex	Cl+Ex
Detector 1 Channel										
Detector 1 Extend (s)	0.0	0.0	0.0	0.0	0.0	0.0	0.0	0.0	0.0	0.0
Detector 1 Queue (s)	0.0	0.0	0.0	0.0	0.0	0.0	0.0	0.0	0.0	0.0
Detector 1 Delay (s)	0.0	0.0	0.0	0.0	0.0	0.0	0.0	0.0	0.0	0.0
Detector 2 Position(ft)		94			94					
Detector 2 Size(ft)		6			6					
Detector 2 Type		Cl+Ex			Cl+Ex					
Detector 2 Channel										
Detector 2 Extend (s)		0.0			0.0					
Turn Type	Prot	NA	Free	Prot	NA	Perm	Perm	Free	Perm	Prot
Protected Phases	1	6		5	2					1
Permitted Phases			Free			2	3	Free	7	

Lanes, Volumes, Timings

1: I65 NB off Ramp /I65 SB off ramp & McEwen/McEwen

11/18/2016

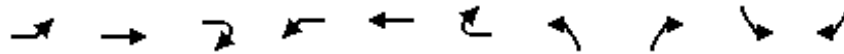

Lane Group	EBL	EBT	EBR2	WBL	WBT	WBR2	NBL	NBR2	SBL	SBR2
Detector Phase	1	6		5	2	2	3		7	1
Switch Phase										
Minimum Initial (s)	8.0	12.0		8.0	12.0	12.0	12.0		12.0	8.0
Minimum Split (s)	15.0	27.0		25.0	27.0	27.0	27.0		27.0	15.0
Total Split (s)	42.0	62.0		34.0	54.0	54.0	54.0		54.0	42.0
Total Split (%)	28.0%	41.3%		22.7%	36.0%	36.0%	36.0%		36.0%	28.0%
Maximum Green (s)	35.0	55.0		27.0	47.0	47.0	47.0		47.0	35.0
Yellow Time (s)	4.0	4.0		4.0	4.0	4.0	4.0		4.0	4.0
All-Red Time (s)	3.0	3.0		3.0	3.0	3.0	3.0		3.0	3.0
Lost Time Adjust (s)	0.0	0.0		0.0	0.0	0.0	0.0		0.0	0.0
Total Lost Time (s)	7.0	7.0		7.0	7.0	7.0	7.0		7.0	7.0
Lead/Lag	Lead	Lag		Lead	Lag	Lag				Lead
Lead-Lag Optimize?										
Vehicle Extension (s)	3.0	3.0		3.0	3.0	3.0	3.0		3.0	3.0
Recall Mode	None	C-Min		None	C-Min	C-Min	None		None	None
Walk Time (s)		7.0			7.0	7.0	7.0		7.0	
Flash Dont Walk (s)		13.0			13.0	13.0	13.0		13.0	
Pedestrian Calls (#/hr)		5			5	5	5		5	
Act Effct Green (s)	27.0	74.1	150.0	19.2	66.3	66.3	35.7	150.0	35.7	27.0
Actuated g/C Ratio	0.18	0.49	1.00	0.13	0.44	0.44	0.24	1.00	0.24	0.18
v/c Ratio	0.78	0.46	0.07	0.73	0.44	0.46	0.75	0.59	0.84	0.62
Control Delay	67.9	23.2	0.1	106.4	11.0	2.2	59.1	1.6	64.9	41.7
Queue Delay	0.0	0.0	0.0	0.0	0.0	0.0	0.0	0.0	0.0	0.0
Total Delay	67.9	23.2	0.1	106.4	11.0	2.2	59.1	1.6	64.9	41.7
LOS	E	C	A	F	B	A	E	A	E	D
Approach Delay		36.6			20.2					
Approach LOS		D			C					
90th %ile Green (s)	33.6	60.2		25.8	52.4	52.4	43.0		43.0	33.6
90th %ile Term Code	Gap	Coord		Gap	Coord	Coord	Hold		Gap	Gap
70th %ile Green (s)	29.4	68.0		21.9	60.5	60.5	39.1		39.1	29.4
70th %ile Term Code	Gap	Coord		Gap	Coord	Coord	Hold		Gap	Gap
50th %ile Green (s)	27.1	74.3		19.2	66.4	66.4	35.5		35.5	27.1
50th %ile Term Code	Gap	Coord		Gap	Coord	Coord	Hold		Gap	Gap
30th %ile Green (s)	24.7	80.0		16.4	71.7	71.7	32.6		32.6	24.7
30th %ile Term Code	Gap	Coord		Gap	Coord	Coord	Hold		Gap	Gap
10th %ile Green (s)	20.3	88.2		12.5	80.4	80.4	28.3		28.3	20.3
10th %ile Term Code	Gap	Coord		Gap	Coord	Coord	Hold		Gap	Gap
Stops (vph)	452	468	0	165	220	61	556	0	635	229
Fuel Used(gal)	12	12	1	6	9	5	14	6	17	7
CO Emissions (g/hr)	854	808	53	420	645	325	984	408	1168	467
NOx Emissions (g/hr)	166	157	10	82	126	63	192	79	227	91
VOC Emissions (g/hr)	198	187	12	97	150	75	228	95	271	108
Dilemma Vehicles (#)	0	0	0	0	0	0	0	0	0	0
Queue Length 50th (ft)	235	273	0	170	50	0	290	0	331	130
Queue Length 95th (ft)	342	256	0	m252	100	0	386	0	437	214
Internal Link Dist (ft)		746			1131					
Turn Bay Length (ft)	370			495						
Base Capacity (vph)	801	1749	1583	318	1563	943	1075	1583	1075	743
Starvation Cap Reductn	0	0	0	0	0	0	0	0	0	0



Lanes, Volumes, Timings

1: I65 NB off Ramp /I65 SB off ramp & McEwen/McEwen

11/18/2016

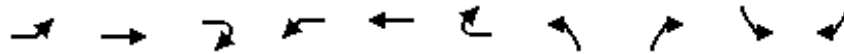

Lane Group	EBL	EBT	EBR2	WBL	WBT	WBR2	NBL	NBR2	SBL	SBR2
Spillback Cap Reductn	0	0	0	0	0	0	0	0	0	0
Storage Cap Reductn	0	0	0	0	0	0	0	0	0	0
Reduced v/c Ratio	0.60	0.46	0.07	0.52	0.44	0.46	0.57	0.59	0.64	0.50

Intersection Summary

Area Type:	Other
Cycle Length:	150
Actuated Cycle Length:	150
Offset:	88 (59%), Referenced to phase 2:WBT and 6:EBT, Start of Yellow
Natural Cycle:	80
Control Type:	Actuated-Coordinated
Maximum v/c Ratio:	0.84
Intersection Signal Delay:	33.0
Intersection LOS:	C
Intersection Capacity Utilization Err%	ICU Level of Service H
Analysis Period (min)	60

m Volume for 95th percentile queue is metered by upstream signal.

Splits and Phases: 1: I65 NB off Ramp /I65 SB off ramp & McEwen/McEwen

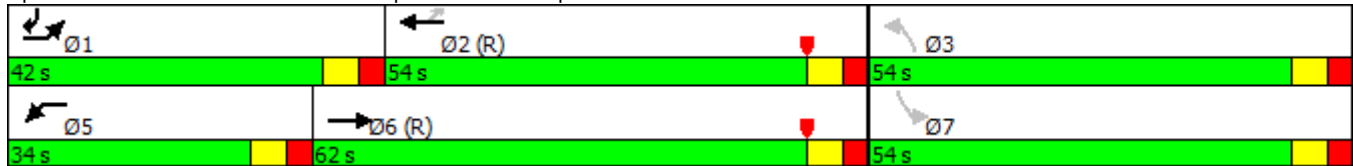

Lanes, Volumes, Timings  
2: McEwen /McEwen & Tower

11/18/2016

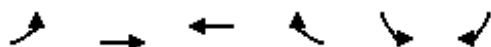

Lane Group	EBL	EBT	WBT	WBR	SBL	SBR
Lane Configurations	↖↖	↗↗	↖↖	↗	↘	↘↘
Traffic Volume (vph)	632	1845	1213	114	19	98
Future Volume (vph)	632	1845	1213	114	19	98
Ideal Flow (vphpl)	1900	1900	1900	1900	1900	1900
Storage Length (ft)	285			115	445	0
Storage Lanes	2			1	1	2
Taper Length (ft)	25				25	
Lane Util. Factor	0.97	0.95	0.95	1.00	1.00	0.88
Fr <sub>t</sub>				0.850		0.850
Fl <sub>t</sub> Protected	0.950				0.950	
Satd. Flow (prot)	3090	3185	3185	1425	1593	2508
Fl <sub>t</sub> Permitted	0.950				0.950	
Satd. Flow (perm)	3090	3185	3185	1425	1593	2508
Right Turn on Red				Yes		Yes
Satd. Flow (RTOR)				40		98
Link Speed (mph)		30	30		30	
Link Distance (ft)		1211	938		511	
Travel Time (s)		27.5	21.3		11.6	
Peak Hour Factor	1.00	1.00	1.00	1.00	1.00	1.00
Adj. Flow (vph)	632	1845	1213	114	19	98
Shared Lane Traffic (%)						
Lane Group Flow (vph)	632	1845	1213	114	19	98
Enter Blocked Intersection	No	No	No	No	No	No
Lane Alignment	Left	Left	Left	Right	Left	Right
Median Width(ft)		24	24		12	
Link Offset(ft)		0	0		0	
Crosswalk Width(ft)		16	16		16	
Two way Left Turn Lane						
Headway Factor	1.14	1.14	1.14	1.14	1.14	1.14
Turning Speed (mph)	15			9	15	9
Number of Detectors	1	2	2	1	1	1
Detector Template	Left	Thru	Thru	Right	Left	Right
Leading Detector (ft)	20	100	100	20	20	20
Trailing Detector (ft)	0	0	0	0	0	0
Detector 1 Position(ft)	0	0	0	0	0	0
Detector 1 Size(ft)	20	6	6	20	20	20
Detector 1 Type	Cl+Ex	Cl+Ex	Cl+Ex	Cl+Ex	Cl+Ex	Cl+Ex
Detector 1 Channel						
Detector 1 Extend (s)	0.0	0.0	0.0	0.0	0.0	0.0
Detector 1 Queue (s)	0.0	0.0	0.0	0.0	0.0	0.0
Detector 1 Delay (s)	0.0	0.0	0.0	0.0	0.0	0.0
Detector 2 Position(ft)		94	94			
Detector 2 Size(ft)		6	6			
Detector 2 Type		Cl+Ex	Cl+Ex			
Detector 2 Channel						
Detector 2 Extend (s)		0.0	0.0			
Turn Type	Prot	NA	NA	Prot	Prot	Prot
Protected Phases	1	6	2	2	8	8
Permitted Phases						

Lanes, Volumes, Timings  
2: McEwen /McEwen & Tower

11/18/2016

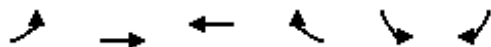

Lane Group	EBL	EBT	WBT	WBR	SBL	SBR
Detector Phase	1	6	2	2	8	8
Switch Phase						
Minimum Initial (s)	7.0	20.0	20.0	20.0	8.0	8.0
Minimum Split (s)	13.5	43.5	43.5	43.5	46.5	46.5
Total Split (s)	38.0	103.5	65.5	65.5	46.5	46.5
Total Split (%)	25.3%	69.0%	43.7%	43.7%	31.0%	31.0%
Maximum Green (s)	32.5	98.0	60.0	60.0	41.0	41.0
Yellow Time (s)	3.5	3.5	3.5	3.5	3.5	3.5
All-Red Time (s)	2.0	2.0	2.0	2.0	2.0	2.0
Lost Time Adjust (s)	0.0	0.0	0.0	0.0	0.0	0.0
Total Lost Time (s)	5.5	5.5	5.5	5.5	5.5	5.5
Lead/Lag	Lead		Lag	Lag		
Lead-Lag Optimize?						
Vehicle Extension (s)	3.0	3.0	3.0	3.0	3.0	3.0
Recall Mode	None	C-Min	C-Min	C-Min	None	None
Walk Time (s)		7.0	7.0	7.0	7.0	7.0
Flash Dont Walk (s)		18.0	18.0	18.0	34.0	34.0
Pedestrian Calls (#/hr)		3	3	3	3	3
Act Effct Green (s)	35.1	124.4	83.8	83.8	14.6	14.6
Actuated g/C Ratio	0.23	0.83	0.56	0.56	0.10	0.10
v/c Ratio	0.88	0.70	0.68	0.14	0.12	0.29
Control Delay	71.8	11.1	10.4	1.8	57.5	10.8
Queue Delay	0.0	0.0	0.0	0.0	0.0	0.0
Total Delay	71.8	11.1	10.4	1.8	57.5	10.8
LOS	E	B	B	A	E	B
Approach Delay		26.6	9.6		18.4	
Approach LOS		C	A		B	
90th %ile Green (s)	32.5	98.0	60.0	60.0	41.0	41.0
90th %ile Term Code	Max	Coord	Coord	Coord	Ped	Ped
70th %ile Green (s)	39.4	130.8	85.9	85.9	8.2	8.2
70th %ile Term Code	Gap	Coord	Coord	Coord	Gap	Gap
50th %ile Green (s)	37.6	131.0	87.9	87.9	8.0	8.0
50th %ile Term Code	Gap	Coord	Coord	Coord	Min	Min
30th %ile Green (s)	35.0	131.0	90.5	90.5	8.0	8.0
30th %ile Term Code	Gap	Coord	Coord	Coord	Min	Min
10th %ile Green (s)	30.8	131.0	94.7	94.7	8.0	8.0
10th %ile Term Code	Gap	Coord	Coord	Coord	Min	Min
Stops (vph)	557	627	413	13	18	14
Fuel Used(gal)	18	25	14	1	0	1
CO Emissions (g/hr)	1278	1751	958	66	28	48
NOx Emissions (g/hr)	249	341	186	13	5	9
VOC Emissions (g/hr)	296	406	222	15	6	11
Dilemma Vehicles (#)	0	0	0	0	0	0
Queue Length 50th (ft)	285	106	69	1	18	0
Queue Length 95th (ft)	#521	#1213	m#841	m41	40	33
Internal Link Dist (ft)		1131	858		431	
Turn Bay Length (ft)	285			115	445	
Base Capacity (vph)	729	2640	1779	813	435	756
Starvation Cap Reductn	0	0	0	0	0	0

Lanes, Volumes, Timings  
 2: McEwen /McEwen & Tower

11/18/2016

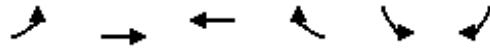

Lane Group	EBL	EBT	WBT	WBR	SBL	SBR
Spillback Cap Reductn	0	0	0	0	0	0
Storage Cap Reductn	0	0	0	0	0	0
Reduced v/c Ratio	0.87	0.70	0.68	0.14	0.04	0.13

Intersection Summary

























Area Type: CBD  
 Cycle Length: 150  
 Actuated Cycle Length: 150  
 Offset: 62 (41%), Referenced to phase 2:WBT and 6:EBT, Start of Yellow  
 Natural Cycle: 105  
 Control Type: Actuated-Coordinated  
 Maximum v/c Ratio: 0.88  
 Intersection Signal Delay: 20.6  
 Intersection LOS: C  
 Intersection Capacity Utilization 77.7%  
 ICU Level of Service D  
 Analysis Period (min) 60  
 # 95th percentile volume exceeds capacity, queue may be longer.  
 Queue shown is maximum after two cycles.  
 m Volume for 95th percentile queue is metered by upstream signal.

Splits and Phases: 2: McEwen /McEwen & Tower



Lanes, Volumes, Timings  
3: Carothers/Carothers & McEwen

11/18/2016

												
Lane Group	EBL	EBT	EBR	WBL	WBT	WBR	NBL	NBT	NBR	SBL	SBT	SBR
Lane Configurations												
Traffic Volume (vph)	871	633	346	104	816	367	234	1016	64	175	267	172
Future Volume (vph)	871	633	346	104	816	367	234	1016	64	175	267	172
Ideal Flow (vphpl)	1900	1900	1900	1900	1900	1900	1900	1900	1900	1900	1900	1900
Storage Length (ft)	205		205	218		97	300		300	280		310
Storage Lanes	2		1	2		1	2		1	2		1
Taper Length (ft)	25			25			25			25		
Lane Util. Factor	0.97	0.95	1.00	0.97	0.95	1.00	0.97	0.95	1.00	0.97	0.95	1.00
Frt			0.850			0.850			0.850			0.850
Flt Protected	0.950			0.950			0.950			0.950		
Satd. Flow (prot)	3433	3539	1583	3433	3539	1583	3433	3539	1583	3433	3539	1583
Flt Permitted	0.950			0.950			0.950			0.950		
Satd. Flow (perm)	3433	3539	1583	3433	3539	1583	3433	3539	1583	3433	3539	1583
Right Turn on Red			Yes			Yes			Yes			Yes
Satd. Flow (RTOR)			313			105			109			65
Link Speed (mph)		30			30			30				40
Link Distance (ft)		938			1960			1936				857
Travel Time (s)		21.3			44.5			44.0				14.6
Peak Hour Factor	1.00	1.00	1.00	1.00	1.00	1.00	1.00	1.00	1.00	1.00	1.00	1.00
Adj. Flow (vph)	871	633	346	104	816	367	234	1016	64	175	267	172
Shared Lane Traffic (%)												
Lane Group Flow (vph)	871	633	346	104	816	367	234	1016	64	175	267	172
Enter Blocked Intersection	No	No	No	No	No	No	No	No	No	No	No	No
Lane Alignment	Left	Left	Right	Left	Left	Right	Left	Left	Right	Left	Left	Right
Median Width(ft)		24			24			24				24
Link Offset(ft)		0			0			0				0
Crosswalk Width(ft)		16			16			16				16
Two way Left Turn Lane												
Headway Factor	1.00	1.00	1.00	1.00	1.00	1.00	1.00	1.00	1.00	1.00	1.00	1.00
Turning Speed (mph)	15		9	15		9	15		9	15		9
Number of Detectors	1	2	1	1	2	1	1	2	1	1	2	1
Detector Template	Left	Thru	Right	Left	Thru	Right	Left	Thru	Right	Left	Thru	Right
Leading Detector (ft)	20	100	20	20	100	20	20	100	20	20	100	20
Trailing Detector (ft)	0	0	0	0	0	0	0	0	0	0	0	0
Detector 1 Position(ft)	0	0	0	0	0	0	0	0	0	0	0	0
Detector 1 Size(ft)	20	6	20	20	6	20	20	6	20	20	6	20
Detector 1 Type	Cl+Ex	Cl+Ex	Cl+Ex	Cl+Ex	Cl+Ex	Cl+Ex	Cl+Ex	Cl+Ex	Cl+Ex	Cl+Ex	Cl+Ex	Cl+Ex
Detector 1 Channel												
Detector 1 Extend (s)	0.0	0.0	0.0	0.0	0.0	0.0	0.0	0.0	0.0	0.0	0.0	0.0
Detector 1 Queue (s)	0.0	0.0	0.0	0.0	0.0	0.0	0.0	0.0	0.0	0.0	0.0	0.0
Detector 1 Delay (s)	0.0	0.0	0.0	0.0	0.0	0.0	0.0	0.0	0.0	0.0	0.0	0.0
Detector 2 Position(ft)		94			94			94				94
Detector 2 Size(ft)		6			6			6				6
Detector 2 Type		Cl+Ex			Cl+Ex			Cl+Ex				Cl+Ex
Detector 2 Channel												
Detector 2 Extend (s)		0.0			0.0			0.0				0.0
Turn Type	Prot	NA	pm+ov	Prot	NA	pm+ov	Prot	NA	custom	Prot	NA	custom
Protected Phases	1	6	7	5	2	3	7	4	5	3	8	1
Permitted Phases			6			2			8			4

Lanes, Volumes, Timings  
3: Carothers/Carothers & McEwen

11/18/2016



Lane Group	EBL	EBT	EBR	WBL	WBT	WBR	NBL	NBT	NBR	SBL	SBT	SBR
Detector Phase	1	6	7	5	2	3	7	4	5	3	8	1
Switch Phase												
Minimum Initial (s)	6.0	13.0	6.0	4.0	13.0	6.0	6.0	13.0	4.0	6.0	13.0	6.0
Minimum Split (s)	13.0	52.0	12.5	10.0	52.0	13.0	12.5	52.0	10.0	13.0	52.0	13.0
Total Split (s)	30.0	69.0	15.0	14.0	53.0	14.0	15.0	53.0	14.0	14.0	52.0	30.0
Total Split (%)	20.0%	46.0%	10.0%	9.3%	35.3%	9.3%	10.0%	35.3%	9.3%	9.3%	34.7%	20.0%
Maximum Green (s)	24.0	63.0	9.0	8.5	47.0	8.0	9.0	47.0	8.5	8.0	46.0	24.0
Yellow Time (s)	4.0	4.0	4.0	3.5	4.0	4.0	4.0	4.0	3.5	4.0	4.0	4.0
All-Red Time (s)	2.0	2.0	2.0	2.0	2.0	2.0	2.0	2.0	2.0	2.0	2.0	2.0
Lost Time Adjust (s)	0.0	0.0	0.0	0.0	0.0	0.0	0.0	0.0	0.0	0.0	0.0	0.0
Total Lost Time (s)	6.0	6.0	6.0	5.5	6.0	6.0	6.0	6.0	5.5	6.0	6.0	6.0
Lead/Lag	Lead	Lag	Lead	Lead	Lag	Lead	Lead	Lag	Lead	Lead	Lag	Lead
Lead-Lag Optimize?												
Vehicle Extension (s)	3.0	3.0	3.0	3.0	3.0	3.0	3.0	3.0	3.0	3.0	3.0	3.0
Recall Mode	Max	C-Max	None	None	C-Max	None	None	None	None	None	None	Max
Walk Time (s)		7.0			7.0			7.0			7.0	
Flash Dont Walk (s)		39.0			39.0			37.0			37.0	
Pedestrian Calls (#/hr)		5			5			5			5	
Act Effct Green (s)	24.7	64.0	79.0	8.2	47.0	61.0	9.0	46.3	59.5	8.0	45.3	77.0
Actuated g/C Ratio	0.16	0.43	0.53	0.05	0.31	0.41	0.06	0.31	0.40	0.05	0.30	0.51
v/c Ratio	1.54	0.42	0.35	0.55	0.74	0.52	1.14	0.93	0.09	0.96	0.25	0.20
Control Delay	1021.7	30.2	7.1	69.0	39.3	22.3	372.2	69.6	0.7	150.5	49.5	16.2
Queue Delay	2.9	0.0	0.0	0.0	0.0	0.3	0.0	0.0	0.0	0.0	0.0	0.0
Total Delay	1024.6	30.2	7.1	69.0	39.3	22.6	372.2	69.6	0.7	150.5	49.5	16.2
LOS	F	C	A	E	D	C	F	E	A	F	D	B
Approach Delay		494.1			37.0			120.1			69.0	
Approach LOS		F			D			F			E	
90th %ile Green (s)	24.0	63.0	9.0	8.5	47.0	8.0	9.0	47.0	8.5	8.0	46.0	24.0
90th %ile Term Code	MaxR	Coord	Max	Max	Coord	Max	Max	Max	Max	Max	Hold	MaxR
70th %ile Green (s)	24.0	63.0	9.0	8.5	47.0	8.0	9.0	47.0	8.5	8.0	46.0	24.0
70th %ile Term Code	MaxR	Coord	Max	Max	Coord	Max	Max	Max	Max	Max	Hold	MaxR
50th %ile Green (s)	24.0	63.0	9.0	8.5	47.0	8.0	9.0	47.0	8.5	8.0	46.0	24.0
50th %ile Term Code	MaxR	Coord	Max	Max	Coord	Max	Max	Max	Max	Max	Hold	MaxR
30th %ile Green (s)	24.0	63.0	9.0	8.5	47.0	8.0	9.0	47.0	8.5	8.0	46.0	24.0
30th %ile Term Code	MaxR	Coord	Max	Max	Coord	Max	Max	Max	Max	Max	Hold	MaxR
10th %ile Green (s)	27.6	67.9	9.0	7.2	47.0	8.0	9.0	43.4	7.2	8.0	42.4	27.6
10th %ile Term Code	MaxR	Coord	Max	Gap	Coord	Max	Max	Gap	Gap	Max	Hold	MaxR
Stops (vph)	815	382	65	101	589	273	206	939	1	156	232	81
Fuel Used(gal)	192	11	3	4	22	9	22	35	1	8	7	2
CO Emissions (g/hr)	13424	743	237	252	1556	614	1566	2440	69	553	456	165
NOx Emissions (g/hr)	2612	145	46	49	303	119	305	475	13	108	89	32
VOC Emissions (g/hr)	3111	172	55	58	361	142	363	566	16	128	106	38
Dilemma Vehicles (#)	0	0	0	0	0	0	0	0	0	0	1	0
Queue Length 50th (ft)	~627	160	45	52	265	152	~137	505	0	91	110	39
Queue Length 95th (ft)	#896	353	m199	m79	419	m233	#265	#767	11	#204	214	186
Internal Link Dist (ft)		858			1880			1856			777	
Turn Bay Length (ft)	205		205	218		97	300		300	280		310
Base Capacity (vph)	565	1509	981	194	1108	706	205	1108	696	183	1085	844
Starvation Cap Reductn	0	0	0	0	0	0	0	0	0	0	0	0

Lanes, Volumes, Timings  
 3: Carothers/Carothers & McEwen

11/18/2016

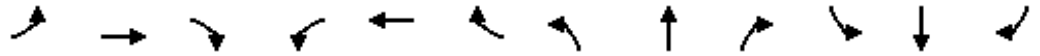

Lane Group	EBL	EBT	EBR	WBL	WBT	WBR	NBL	NBT	NBR	SBL	SBT	SBR
Spillback Cap Reductn	134	0	0	0	0	63	0	0	0	0	0	0
Storage Cap Reductn	0	0	0	0	0	0	0	0	0	0	0	0
Reduced v/c Ratio	2.02	0.42	0.35	0.54	0.74	0.57	1.14	0.92	0.09	0.96	0.25	0.20

Intersection Summary

Area Type: Other  
 Cycle Length: 150  
 Actuated Cycle Length: 150  
 Offset: 8 (5%), Referenced to phase 2:WBT and 6:EBT, Start of Yellow  
 Natural Cycle: 130  
 Control Type: Actuated-Coordinated  
 Maximum v/c Ratio: 1.54  
 Intersection Signal Delay: 229.4  
 Intersection LOS: F  
 Intersection Capacity Utilization 100.5%  
 ICU Level of Service G  
 Analysis Period (min) 60

~ Volume exceeds capacity, queue is theoretically infinite.

Queue shown is maximum after two cycles.

# 95th percentile volume exceeds capacity, queue may be longer.

Queue shown is maximum after two cycles.

m Volume for 95th percentile queue is metered by upstream signal.

Splits and Phases: 3: Carothers/Carothers & McEwen





Lanes, Volumes, Timings  
4: Ovation/Resource Parkway & McEwen

11/18/2016



Lane Group	EBL	EBT	EBR	WBL	WBT	WBR	NBL	NBT	NBR	SBL	SBT	SBR
Lane Configurations												
Traffic Volume (vph)	113	268	381	160	1051	59	145	30	21	21	85	105
Future Volume (vph)	113	268	381	160	1051	59	145	30	21	21	85	105
Ideal Flow (vphpl)	1900	1900	1900	1900	1900	1900	1900	1900	1900	1900	1900	1900
Lane Util. Factor	1.00	0.95	1.00	1.00	0.95	0.95	0.97	1.00	1.00	1.00	1.00	1.00
Fr <sub>t</sub>			0.850		0.992				0.850		0.917	
Fl <sub>t</sub> Protected	0.950			0.950			0.950			0.950		
Satd. Flow (prot)	1770	3539	1583	1770	3511	0	3433	1863	1583	1770	1708	0
Fl <sub>t</sub> Permitted	0.140			0.563			0.456			0.738		
Satd. Flow (perm)	261	3539	1583	1049	3511	0	1648	1863	1583	1375	1708	0
Right Turn on Red			Yes			Yes			Yes			Yes
Satd. Flow (RTOR)			381		9				73		75	
Link Speed (mph)		30			30			30			30	
Link Distance (ft)		1960			345			402			456	
Travel Time (s)		44.5			7.8			9.1			10.4	
Peak Hour Factor	1.00	1.00	1.00	1.00	1.00	1.00	1.00	1.00	1.00	1.00	1.00	1.00
Adj. Flow (vph)	113	268	381	160	1051	59	145	30	21	21	85	105
Shared Lane Traffic (%)												
Lane Group Flow (vph)	113	268	381	160	1110	0	145	30	21	21	190	0
Enter Blocked Intersection	No	No	No	No	No	No	No	No	No	No	No	No
Lane Alignment	Left	Left	Right	Left	Left	Right	Left	Left	Right	Left	Left	Right
Median Width(ft)		36			36			24			24	
Link Offset(ft)		0			0			0			0	
Crosswalk Width(ft)		16			16			16			16	
Two way Left Turn Lane												
Headway Factor	1.00	1.00	1.00	1.00	1.00	1.00	1.00	1.00	1.00	1.00	1.00	1.00
Turning Speed (mph)	15		9	15		9	15		9	15		9
Number of Detectors	1	2	1	1	2		1	2	1	1	2	
Detector Template	Left	Thru	Right	Left	Thru		Left	Thru	Right	Left	Thru	
Leading Detector (ft)	20	100	20	20	100		20	100	20	20	100	
Trailing Detector (ft)	0	0	0	0	0		0	0	0	0	0	
Detector 1 Position(ft)	0	0	0	0	0		0	0	0	0	0	
Detector 1 Size(ft)	20	6	20	20	6		20	6	20	20	6	
Detector 1 Type	Cl+Ex	Cl+Ex	Cl+Ex	Cl+Ex	Cl+Ex		Cl+Ex	Cl+Ex	Cl+Ex	Cl+Ex	Cl+Ex	
Detector 1 Channel												
Detector 1 Extend (s)	0.0	0.0	0.0	0.0	0.0		0.0	0.0	0.0	0.0	0.0	
Detector 1 Queue (s)	0.0	0.0	0.0	0.0	0.0		0.0	0.0	0.0	0.0	0.0	
Detector 1 Delay (s)	0.0	0.0	0.0	0.0	0.0		0.0	0.0	0.0	0.0	0.0	
Detector 2 Position(ft)		94			94			94			94	
Detector 2 Size(ft)		6			6			6			6	
Detector 2 Type		Cl+Ex			Cl+Ex			Cl+Ex			Cl+Ex	
Detector 2 Channel												
Detector 2 Extend (s)		0.0			0.0			0.0			0.0	
Turn Type	pm+pt	NA	pm+ov	pm+pt	NA		pm+pt	NA	pm+ov	pm+pt	NA	
Protected Phases	3	8	1	7	4		1	6	7	5	2	
Permitted Phases	8		8	4			6		6	2		
Detector Phase	3	8	1	7	4		1	6	7	5	2	
Switch Phase												
Minimum Initial (s)	4.0	4.0	4.0	4.0	4.0		4.0	4.0	4.0	4.0	4.0	

Lanes, Volumes, Timings  
4: Ovation/Resource Parkway & McEwen

11/18/2016



Lane Group	EBL	EBT	EBR	WBL	WBT	WBR	NBL	NBT	NBR	SBL	SBT	SBR
Minimum Split (s)	10.0	20.0	10.0	10.0	20.0		10.0	20.0	10.0	10.0	20.0	
Total Split (s)	10.0	35.0	10.0	10.0	35.0		10.0	20.0	10.0	10.0	20.0	
Total Split (%)	13.3%	46.7%	13.3%	13.3%	46.7%		13.3%	26.7%	13.3%	13.3%	26.7%	
Maximum Green (s)	6.0	31.0	6.0	6.0	31.0		6.0	16.0	6.0	6.0	16.0	
Yellow Time (s)	3.5	3.5	3.5	3.5	3.5		3.5	3.5	3.5	3.5	3.5	
All-Red Time (s)	0.5	0.5	0.5	0.5	0.5		0.5	0.5	0.5	0.5	0.5	
Lost Time Adjust (s)	0.0	0.0	0.0	0.0	0.0		0.0	0.0	0.0	0.0	0.0	
Total Lost Time (s)	4.0	4.0	4.0	4.0	4.0		4.0	4.0	4.0	4.0	4.0	
Lead/Lag	Lead	Lag	Lead	Lead	Lag		Lead	Lag	Lead	Lead	Lag	
Lead-Lag Optimize?												
Vehicle Extension (s)	3.0	3.0	3.0	3.0	3.0		3.0	3.0	3.0	3.0	3.0	
Recall Mode	None	C-Max	None	None	C-Max		None	Max	None	None	Max	
Walk Time (s)		5.0			5.0			5.0			5.0	
Flash Dont Walk (s)		11.0			11.0			11.0			11.0	
Pedestrian Calls (#/hr)		10			10			10			10	
Act Effect Green (s)	37.0	31.0	41.0	37.8	33.0		24.4	22.0	32.0	21.8	16.0	
Actuated g/C Ratio	0.49	0.41	0.55	0.50	0.44		0.33	0.29	0.43	0.29	0.21	
v/c Ratio	0.46	0.18	0.37	0.27	0.72		0.21	0.05	0.03	0.05	0.45	
Control Delay	14.4	15.5	9.7	10.0	21.0		17.7	22.4	0.1	16.8	19.4	
Queue Delay	0.0	0.0	0.0	0.0	0.0		0.0	0.0	0.0	0.0	0.0	
Total Delay	14.4	15.5	9.7	10.0	21.0		17.7	22.4	0.1	16.8	19.4	
LOS	B	B	A	A	C		B	C	A	B	B	
Approach Delay		12.4			19.6			16.5			19.1	
Approach LOS		B			B			B			B	
90th %ile Green (s)	6.0	31.0	6.0	6.0	31.0		6.0	16.0	6.0	6.0	16.0	
90th %ile Term Code	Max	Coord	Max	Max	Coord		Max	MaxR	Max	Max	MaxR	
70th %ile Green (s)	6.0	31.0	6.0	6.0	31.0		6.0	16.0	6.0	6.0	16.0	
70th %ile Term Code	Max	Coord	Max	Max	Coord		Max	MaxR	Max	Max	MaxR	
50th %ile Green (s)	6.0	31.0	6.0	6.0	31.0		6.0	26.0	6.0	0.0	16.0	
50th %ile Term Code	Max	Coord	Max	Max	Coord		Max	MaxR	Max	Skip	MaxR	
30th %ile Green (s)	6.0	31.0	6.0	6.0	31.0		6.0	26.0	6.0	0.0	16.0	
30th %ile Term Code	Max	Coord	Max	Max	Coord		Max	MaxR	Max	Skip	MaxR	
10th %ile Green (s)	0.0	31.0	6.0	6.0	41.0		6.0	26.0	6.0	0.0	16.0	
10th %ile Term Code	Skip	Coord	Max	Max	Coord		Max	MaxR	Max	Skip	MaxR	
Stops (vph)	70	216	209	78	875		97	25	0	17	100	
Fuel Used(gal)	2	6	8	1	13		2	0	0	0	2	
CO Emissions (g/hr)	171	429	540	83	879		106	26	5	17	138	
NOx Emissions (g/hr)	33	83	105	16	171		21	5	1	3	27	
VOC Emissions (g/hr)	40	99	125	19	204		25	6	1	4	32	
Dilemma Vehicles (#)	0	0	0	0	0		0	0	0	0	0	
Queue Length 50th (ft)	39	64	139	34	223		23	9	0	6	45	
Queue Length 95th (ft)	m67	m92	m257	71	#373		47	36	0	23	122	
Internal Link Dist (ft)		1880			265			322			376	
Turn Bay Length (ft)												
Base Capacity (vph)	249	1462	1038	586	1549		679	546	717	434	423	
Starvation Cap Reductn	0	0	0	0	0		0	0	0	0	0	
Spillback Cap Reductn	0	0	0	0	0		0	0	0	0	0	
Storage Cap Reductn	0	0	0	0	0		0	0	0	0	0	
Reduced v/c Ratio	0.45	0.18	0.37	0.27	0.72		0.21	0.05	0.03	0.05	0.45	

Intersection Summary





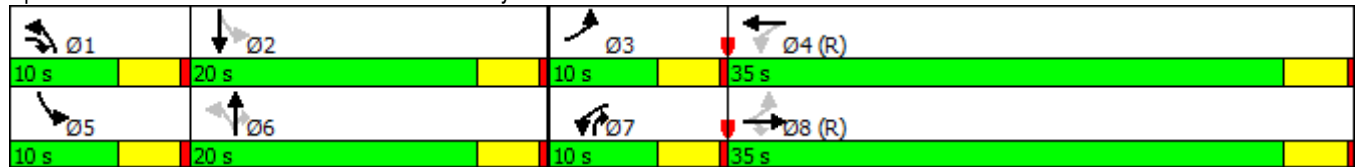





















Area Type:	Other
Cycle Length:	75
Actuated Cycle Length:	75
Offset:	8 (11%), Referenced to phase 4:WBTL and 8:EBTL, Start of Green
Natural Cycle:	65
Control Type:	Actuated-Coordinated
Maximum v/c Ratio:	0.72
Intersection Signal Delay:	17.1
Intersection LOS:	B
Intersection Capacity Utilization:	65.6%
ICU Level of Service:	C
Analysis Period (min):	60
#	95th percentile volume exceeds capacity, queue may be longer. Queue shown is maximum after two cycles.
m	Volume for 95th percentile queue is metered by upstream signal.

Splits and Phases: 4: Ovation/Resource Parkway & McEwen



Lanes, Volumes, Timings  
5: Carothers /Carothers & Tower/Pacific

11/18/2016

												
Lane Group	EBL	EBT	EBR	WBL	WBT	WBR	NBL	NBT	NBR	SBL	SBT	SBR
Lane Configurations	 							 			 	
Traffic Volume (vph)	109	0	53	28	1	14	195	2086	6	3	545	320
Future Volume (vph)	109	0	53	28	1	14	195	2086	6	3	545	320
Ideal Flow (vphpl)	1900	1900	1900	1900	1900	1900	1900	1900	1900	1900	1900	1900
Grade (%)		0%			0%			2%			0%	
Storage Length (ft)	84		78	106		77	177		100	85		144
Storage Lanes	2		1	1		1	1		1	1		1
Taper Length (ft)	25			25			25			25		
Lane Util. Factor	0.97	1.00	1.00	1.00	1.00	1.00	1.00	0.95	1.00	1.00	0.95	1.00
Fr <sub>t</sub>			0.850				0.850			0.850		0.850
Fl <sub>t</sub> Protected	0.950			0.950			0.950			0.950		
Satd. Flow (prot)	3433	1863	1583	1770	1863	1583	1752	3504	1567	1770	3539	1583
Fl <sub>t</sub> Permitted	0.950			0.950			0.401			0.043		
Satd. Flow (perm)	3433	1863	1583	1770	1863	1583	739	3504	1567	80	3539	1583
Right Turn on Red			Yes			Yes			Yes			Yes
Satd. Flow (RTOR)			316			102			98			320
Link Speed (mph)		30			30			40			30	
Link Distance (ft)		881			890			857			905	
Travel Time (s)		20.0			20.2			14.6			20.6	
Peak Hour Factor	1.00	1.00	1.00	1.00	1.00	1.00	1.00	1.00	1.00	1.00	1.00	1.00
Adj. Flow (vph)	109	0	53	28	1	14	195	2086	6	3	545	320
Shared Lane Traffic (%)												
Lane Group Flow (vph)	109	0	53	28	1	14	195	2086	6	3	545	320
Enter Blocked Intersection	No	No	No	No	No	No	No	No	No	No	No	No
Lane Alignment	Left	Left	Right	Left	Left	Right	Left	Left	Right	Left	Left	Right
Median Width(ft)		24			24			24			24	
Link Offset(ft)		0			0			0			0	
Crosswalk Width(ft)		16			16			16			16	
Two way Left Turn Lane												
Headway Factor	1.00	1.00	1.00	1.00	1.00	1.00	1.01	1.01	1.01	1.00	1.00	1.00
Turning Speed (mph)	15		9	15		9	15		9	15		9
Number of Detectors	1	2	1	1	2	1	1	2	1	1	2	1
Detector Template	Left	Thru	Right	Left	Thru	Right	Left	Thru	Right	Left	Thru	Right
Leading Detector (ft)	20	100	20	20	100	20	20	100	20	20	100	20
Trailing Detector (ft)	0	0	0	0	0	0	0	0	0	0	0	0
Detector 1 Position(ft)	0	0	0	0	0	0	0	0	0	0	0	0
Detector 1 Size(ft)	20	6	20	20	6	20	20	6	20	20	6	20
Detector 1 Type	Cl+Ex	Cl+Ex	Cl+Ex	Cl+Ex	Cl+Ex	Cl+Ex	Cl+Ex	Cl+Ex	Cl+Ex	Cl+Ex	Cl+Ex	Cl+Ex
Detector 1 Channel												
Detector 1 Extend (s)	0.0	0.0	0.0	0.0	0.0	0.0	0.0	0.0	0.0	0.0	0.0	0.0
Detector 1 Queue (s)	0.0	0.0	0.0	0.0	0.0	0.0	0.0	0.0	0.0	0.0	0.0	0.0
Detector 1 Delay (s)	0.0	0.0	0.0	0.0	0.0	0.0	0.0	0.0	0.0	0.0	0.0	0.0
Detector 2 Position(ft)		94			94			94			94	
Detector 2 Size(ft)		6			6			6			6	
Detector 2 Type		Cl+Ex			Cl+Ex			Cl+Ex			Cl+Ex	
Detector 2 Channel												
Detector 2 Extend (s)		0.0			0.0			0.0			0.0	
Turn Type	Prot		Perm	Prot	NA	Perm	pm+pt	NA	Perm	pm+pt	NA	Perm
Protected Phases	3	8		7	4		1	6		5	2	

Lanes, Volumes, Timings  
5: Carothers /Carothers & Tower/Pacific

11/18/2016



Lane Group	EBL	EBT	EBR	WBL	WBT	WBR	NBL	NBT	NBR	SBL	SBT	SBR
Permitted Phases			8			4	6		6	2		2
Detector Phase	3	8	8	7	4	4	1	6	6	5	2	2
Switch Phase												
Minimum Initial (s)	6.0	8.0	8.0	6.0	8.0	8.0	6.0	20.0	20.0	6.0	20.0	20.0
Minimum Split (s)	12.5	48.5	48.5	12.5	48.5	48.5	12.0	42.0	42.0	12.0	42.0	42.0
Total Split (s)	12.5	48.5	48.5	12.5	48.5	48.5	16.0	77.0	77.0	12.0	73.0	73.0
Total Split (%)	8.3%	32.3%	32.3%	8.3%	32.3%	32.3%	10.7%	51.3%	51.3%	8.0%	48.7%	48.7%
Maximum Green (s)	7.0	43.0	43.0	7.0	43.0	43.0	10.5	71.0	71.0	6.5	67.0	67.0
Yellow Time (s)	3.5	3.5	3.5	3.5	3.5	3.5	3.5	4.0	4.0	3.5	4.0	4.0
All-Red Time (s)	2.0	2.0	2.0	2.0	2.0	2.0	2.0	2.0	2.0	2.0	2.0	2.0
Lost Time Adjust (s)	0.0	0.0	0.0	0.0	0.0	0.0	0.0	0.0	0.0	0.0	0.0	0.0
Total Lost Time (s)	5.5	5.5	5.5	5.5	5.5	5.5	5.5	6.0	6.0	5.5	6.0	6.0
Lead/Lag	Lead	Lag	Lag	Lead	Lag	Lag	Lead	Lag	Lag	Lead	Lag	Lag
Lead-Lag Optimize?												
Vehicle Extension (s)	3.0	3.0	3.0	3.0	3.0	3.0	3.0	3.0	3.0	3.0	3.0	3.0
Recall Mode	None	None	None	None	None	None	None	C-Min	C-Min	None	C-Min	C-Min
Walk Time (s)		7.0	7.0		7.0	7.0		7.0	7.0		7.0	7.0
Flash Dont Walk (s)		36.0	36.0		36.0	36.0		29.0	29.0		29.0	29.0
Pedestrian Calls (#/hr)		10	10		10	10		10	10		10	10
Act Effct Green (s)	7.4		22.0	6.7	22.0	22.0	109.3	106.7	106.7	101.1	94.6	94.6
Actuated g/C Ratio	0.05		0.15	0.04	0.15	0.15	0.73	0.71	0.71	0.67	0.63	0.63
v/c Ratio	0.64		0.11	0.35	0.00	0.04	0.33	0.84	0.01	0.02	0.24	0.29
Control Delay	88.8		0.4	82.5	41.0	0.3	4.3	16.1	0.0	12.3	11.5	1.3
Queue Delay	0.0		0.0	0.0	0.0	0.0	0.0	10.7	0.0	0.0	0.0	0.0
Total Delay	88.8		0.4	82.5	41.0	0.3	4.3	26.9	0.0	12.3	11.5	1.3
LOS	F		A	F	D	A	A	C	A	B	B	A
Approach Delay					54.7			24.9			7.8	
Approach LOS					D			C			A	
90th %ile Green (s)	7.0	43.0	43.0	7.0	43.0	43.0	10.5	71.5	71.5	6.0	67.0	67.0
90th %ile Term Code	Max	Ped	Ped	Max	Ped	Ped	Max	Coord	Coord	Min	Coord	Coord
70th %ile Green (s)	7.0	43.0	43.0	7.0	43.0	43.0	10.5	83.0	83.0	0.0	67.0	67.0
70th %ile Term Code	Max	Ped	Ped	Max	Ped	Ped	Max	Coord	Coord	Skip	Coord	Coord
50th %ile Green (s)	7.0	8.0	8.0	7.0	8.0	8.0	9.4	118.0	118.0	0.0	103.1	103.1
50th %ile Term Code	Max	Min	Min	Max	Min	Min	Gap	Coord	Coord	Skip	Coord	Coord
30th %ile Green (s)	8.0	8.0	8.0	0.0	0.0	0.0	7.3	130.5	130.5	0.0	117.7	117.7
30th %ile Term Code	Hold	Min	Min	Skip	Skip	Skip	Gap	Coord	Coord	Skip	Coord	Coord
10th %ile Green (s)	8.0	8.0	8.0	0.0	0.0	0.0	6.7	130.5	130.5	0.0	118.3	118.3
10th %ile Term Code	Hold	Hold	Hold	Skip	Skip	Skip	Gap	Coord	Coord	Skip	Coord	Coord
Stops (vph)	103		0	28	2	0	38	891	0	1	139	8
Fuel Used(gal)	3		0	1	0	0	2	28	0	0	6	2
CO Emissions (g/hr)	230		26	57	2	7	117	1938	2	2	412	167
NOx Emissions (g/hr)	45		5	11	0	1	23	377	0	0	80	32
VOC Emissions (g/hr)	53		6	13	0	2	27	449	1	1	95	39
Dilemma Vehicles (#)	0		0	0	0	0	0	24	0	0	0	0
Queue Length 50th (ft)	55		0	27	1	0	9	142	0	1	76	0
Queue Length 95th (ft)	#118		0	70	6	0	m58	m#1216	m0	m3	112	37
Internal Link Dist (ft)		801			810			777			825	
Turn Bay Length (ft)	84		78	106		77	177		100	85		144
Base Capacity (vph)	169		679	82	534	526	609	2492	1143	127	2232	1117

Lanes, Volumes, Timings  
 5: Carothers /Carothers & Tower/Pacific

11/18/2016



Lane Group	EBL	EBT	EBR	WBL	WBT	WBR	NBL	NBT	NBR	SBL	SBT	SBR
Starvation Cap Reductn	0		0	0	0	0	0	375	0	0	0	0
Spillback Cap Reductn	0		0	0	0	0	0	182	0	0	0	0
Storage Cap Reductn	0		0	0	0	0	0	0	0	0	0	0
Reduced v/c Ratio	0.64		0.08	0.34	0.00	0.03	0.32	0.99	0.01	0.02	0.24	0.29

Intersection Summary

Area Type: Other  
 Cycle Length: 150  
 Actuated Cycle Length: 150  
 Offset: 0 (0%), Referenced to phase 2:SBTL and 6:NBTL, Start of Yellow  
 Natural Cycle: 115  
 Control Type: Actuated-Coordinated  
 Maximum v/c Ratio: 0.84  
 Intersection Signal Delay: 22.5 Intersection LOS: C  
 Intersection Capacity Utilization 86.6% ICU Level of Service E  
 Analysis Period (min) 60  
 # 95th percentile volume exceeds capacity, queue may be longer.  
 Queue shown is maximum after two cycles.  
 m Volume for 95th percentile queue is metered by upstream signal.

Splits and Phases: 5: Carothers /Carothers & Tower/Pacific

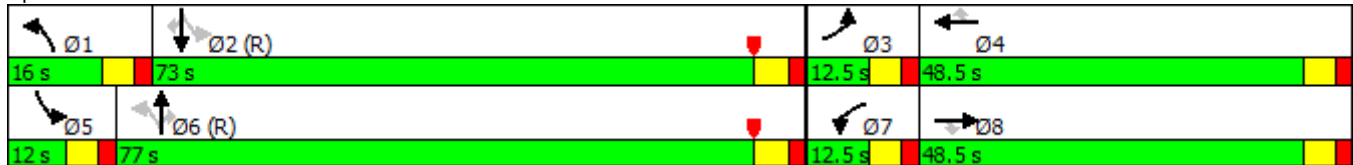

Lanes, Volumes, Timings

6: Carothers/Carothers Parkway & Apartments/Resource

11/18/2016



Lane Group	EBL	EBT	EBR	WBL	WBT	WBR	NBL	NBT	NBR	SBL	SBT	SBR
Lane Configurations												
Traffic Volume (vph)	35	0	52	9	0	93	123	2150	1	92	822	184
Future Volume (vph)	35	0	52	9	0	93	123	2150	1	92	822	184
Ideal Flow (vphpl)	1900	1900	1900	1900	1900	1900	1900	1900	1900	1900	1900	1900
Grade (%)		0%			0%			2%			0%	
Storage Length (ft)	0		0	0		0	210		128	480		93
Storage Lanes	1		0	1		1	1		0	1		1
Taper Length (ft)	25			25			25			25		
Lane Util. Factor	1.00	1.00	1.00	1.00	1.00	1.00	1.00	0.95	0.95	1.00	0.95	1.00
Frt		0.850				0.850						0.850
Flt Protected	0.950			0.950			0.950			0.950		
Satd. Flow (prot)	1770	1583	0	1770	1863	1583	1752	3504	0	1770	3539	1583
Flt Permitted	0.592			0.723			0.297			0.042		
Satd. Flow (perm)	1103	1583	0	1347	1863	1583	548	3504	0	78	3539	1583
Right Turn on Red			Yes			Yes			Yes			Yes
Satd. Flow (RTOR)		249				79						104
Link Speed (mph)		30			30			40				40
Link Distance (ft)		762			773			905				2004
Travel Time (s)		17.3			17.6			15.4				34.2
Peak Hour Factor	1.00	1.00	1.00	1.00	1.00	1.00	1.00	1.00	1.00	1.00	1.00	1.00
Adj. Flow (vph)	35	0	52	9	0	93	123	2150	1	92	822	184
Shared Lane Traffic (%)												
Lane Group Flow (vph)	35	52	0	9	0	93	123	2151	0	92	822	184
Enter Blocked Intersection	No	No	No	No	No	No	No	No	No	No	No	No
Lane Alignment	Left	Left	Right	Left	Left	Right	Left	Left	Right	Left	Left	Right
Median Width(ft)		12			12			12				12
Link Offset(ft)		0			0			0				0
Crosswalk Width(ft)		16			16			16				16
Two way Left Turn Lane												
Headway Factor	1.00	1.00	1.00	1.00	1.00	1.00	1.01	1.01	1.01	1.00	1.00	1.00
Turning Speed (mph)	15		9	15		9	15		9	15		9
Number of Detectors	1	2		1	2	1	1	2		1	2	1
Detector Template	Left	Thru		Left	Thru	Right	Left	Thru		Left	Thru	Right
Leading Detector (ft)	20	100		20	100	20	20	100		20	100	20
Trailing Detector (ft)	0	0		0	0	0	0	0		0	0	0
Detector 1 Position(ft)	0	0		0	0	0	0	0		0	0	0
Detector 1 Size(ft)	20	6		20	6	20	20	6		20	6	20
Detector 1 Type	Cl+Ex	Cl+Ex		Cl+Ex	Cl+Ex	Cl+Ex	Cl+Ex	Cl+Ex		Cl+Ex	Cl+Ex	Cl+Ex
Detector 1 Channel												
Detector 1 Extend (s)	0.0	0.0		0.0	0.0	0.0	0.0	0.0		0.0	0.0	0.0
Detector 1 Queue (s)	0.0	0.0		0.0	0.0	0.0	0.0	0.0		0.0	0.0	0.0
Detector 1 Delay (s)	0.0	0.0		0.0	0.0	0.0	0.0	0.0		0.0	0.0	0.0
Detector 2 Position(ft)		94			94			94				94
Detector 2 Size(ft)		6			6			6				6
Detector 2 Type		Cl+Ex			Cl+Ex			Cl+Ex				Cl+Ex
Detector 2 Channel												
Detector 2 Extend (s)		0.0			0.0			0.0				0.0
Turn Type	pm+pt	NA		pm+pt		pm+ov	pm+pt	NA		pm+pt	NA	pm+ov
Protected Phases	3	8		7	4	5	1	6		5	2	3



Lanes, Volumes, Timings  
6: Carothers/Carothers Parkway & Apartments/Resource

11/18/2016



Lane Group	EBL	EBT	EBR	WBL	WBT	WBR	NBL	NBT	NBR	SBL	SBT	SBR
Permitted Phases	8			4		4	6			2		2
Detector Phase	3	8		7	4	5	1	6		5	2	3
Switch Phase												
Minimum Initial (s)	5.0	6.0		5.0	6.0	5.0	5.0	15.0		5.0	15.0	5.0
Minimum Split (s)	12.0	48.5		12.0	48.5	11.5	11.5	48.0		11.5	48.0	12.0
Total Split (s)	12.0	48.5		12.0	48.5	11.5	15.2	78.0		11.5	74.3	12.0
Total Split (%)	8.0%	32.3%		8.0%	32.3%	7.7%	10.1%	52.0%		7.7%	49.5%	8.0%
Maximum Green (s)	6.5	43.0		6.5	43.0	6.0	9.7	72.0		6.0	68.3	6.5
Yellow Time (s)	3.5	3.5		3.5	3.5	3.5	3.5	4.0		3.5	4.0	3.5
All-Red Time (s)	2.0	2.0		2.0	2.0	2.0	2.0	2.0		2.0	2.0	2.0
Lost Time Adjust (s)	0.0	0.0		0.0	0.0	0.0	0.0	0.0		0.0	0.0	0.0
Total Lost Time (s)	5.5	5.5		5.5	5.5	5.5	5.5	6.0		5.5	6.0	5.5
Lead/Lag	Lead	Lag		Lead	Lag	Lead	Lead	Lag		Lead	Lag	Lead
Lead-Lag Optimize?												
Vehicle Extension (s)	3.0	3.0		3.0	3.0	3.0	3.0	3.0		3.0	3.0	3.0
Recall Mode	None	None		None	None	None	None	C-Max		None	C-Max	None
Walk Time (s)		7.0			7.0			7.0			7.0	
Flash Dont Walk (s)		36.0			36.0			35.0			35.0	
Pedestrian Calls (#/hr)		10			10			10			10	
Act Effct Green (s)	24.7	23.4		23.2		25.9	108.9	100.7		106.5	99.5	111.9
Actuated g/C Ratio	0.16	0.16		0.15		0.17	0.73	0.67		0.71	0.66	0.75
v/c Ratio	0.17	0.11		0.04		0.27	0.27	0.91		0.72	0.35	0.15
Control Delay	44.9	0.5		38.0		11.8	3.0	16.1		61.2	16.5	5.8
Queue Delay	0.0	0.0		0.0		0.0	0.0	0.7		0.0	0.0	0.0
Total Delay	44.9	0.5		38.0		11.8	3.0	16.7		61.2	16.5	5.8
LOS	D	A		D		B	A	B		E	B	A
Approach Delay		18.4						16.0			18.4	
Approach LOS		B						B			B	
90th %ile Green (s)	6.5	43.0		6.5	43.0	6.0	9.7	72.0		6.0	68.3	6.5
90th %ile Term Code	Max	Ped		Max	Ped	Max	Max	Coord		Max	Coord	Max
70th %ile Green (s)	6.5	55.0		0.0	43.0	6.0	9.7	72.0		6.0	68.3	6.5
70th %ile Term Code	Max	Hold		Skip	Ped	Max	Max	Coord		Max	Coord	Max
50th %ile Green (s)	6.5	6.5		0.0	0.0	7.2	6.8	119.3		7.2	119.7	6.5
50th %ile Term Code	Max	Hold		Skip	Skip	Gap	Gap	Coord		Gap	Coord	Max
30th %ile Green (s)	6.5	6.5		0.0	0.0	6.9	6.4	119.6		6.9	120.1	6.5
30th %ile Term Code	Max	Hold		Skip	Skip	Gap	Gap	Coord		Gap	Coord	Max
10th %ile Green (s)	6.0	6.0		0.0	0.0	6.5	6.0	120.5		6.5	121.0	6.0
10th %ile Term Code	Hold	Hold		Skip	Skip	Gap	Gap	Coord		Gap	Coord	Hold
Stops (vph)	27	0		8		18	8	598		37	373	31
Fuel Used(gal)	1	0		0		1	1	26		3	18	3
CO Emissions (g/hr)	47	22		12		62	63	1826		193	1230	211
NOx Emissions (g/hr)	9	4		2		12	12	355		38	239	41
VOC Emissions (g/hr)	11	5		3		14	15	423		45	285	49
Dilemma Vehicles (#)	0	0		0		0	0	17		0	27	0
Queue Length 50th (ft)	34	0		9		13	6	64		24	95	7
Queue Length 95th (ft)	54	0		21		61	m10	#1787		#199	415	96
Internal Link Dist (ft)		682			693			825			1924	
Turn Bay Length (ft)							210			480		93
Base Capacity (vph)	211	652		230		339	483	2351		128	2347	1208

Lanes, Volumes, Timings  
 6: Carothers/Carothers Parkway & Apartments/Resource

11/18/2016

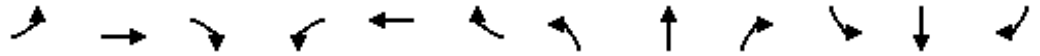

Lane Group	EBL	EBT	EBR	WBL	WBT	WBR	NBL	NBT	NBR	SBL	SBT	SBR
Starvation Cap Reductn	0	0		0		0	0	41		0	0	0
Spillback Cap Reductn	0	0		0		0	0	0		0	0	0
Storage Cap Reductn	0	0		0		0	0	0		0	0	0
Reduced v/c Ratio	0.17	0.08		0.04		0.27	0.25	0.93		0.72	0.35	0.15

Intersection Summary

Area Type: Other  
 Cycle Length: 150  
 Actuated Cycle Length: 150  
 Offset: 16 (11%), Referenced to phase 2:SBTL and 6:NBTL, Start of Yellow  
 Natural Cycle: 120  
 Control Type: Actuated-Coordinated  
 Maximum v/c Ratio: 0.91  
 Intersection Signal Delay: 16.8 Intersection LOS: B  
 Intersection Capacity Utilization 87.3% ICU Level of Service E  
 Analysis Period (min) 60  
 # 95th percentile volume exceeds capacity, queue may be longer.  
 Queue shown is maximum after two cycles.  
 m Volume for 95th percentile queue is metered by upstream signal.

Splits and Phases: 6: Carothers/Carothers Parkway & Apartments/Resource

15.2 s	74.3 s	12 s	48.5 s
11.5 s	78 s	12 s	48.5 s

Lanes, Volumes, Timings

1: I65 NB off Ramp /I65 SB off ramp & McEwen/McEwen

11/18/2016

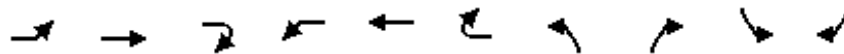

Lane Group	EBL	EBT	EBR2	WBL	WBT	WBR2	NBL	NBR2	SBL	SBR2
Lane Configurations										
Traffic Volume (vph)	572	875	366	513	1162	1124	285	161	605	671
Future Volume (vph)	572	875	366	513	1162	1124	285	161	605	671
Ideal Flow (vphpl)	1900	1900	1900	1900	1900	1900	1900	1900	1900	1900
Storage Length (ft)	370			495			0		0	
Storage Lanes	2			1			2		2	
Taper Length (ft)	25			25			25		25	
Lane Util. Factor	0.97	0.95	1.00	1.00	0.95	1.00	0.97	1.00	0.97	0.88
Frt			0.850				0.850		0.850	0.850
Flt Protected	0.950			0.950			0.950		0.950	
Satd. Flow (prot)	3433	3539	1583	1770	3539	1583	3433	1583	3433	2787
Flt Permitted	0.950			0.950			0.950		0.950	
Satd. Flow (perm)	3433	3539	1583	1770	3539	1583	3433	1583	3433	2787
Right Turn on Red			Yes			Yes		Yes		Yes
Satd. Flow (RTOR)			210			523		182		131
Link Speed (mph)		30			30					
Link Distance (ft)		826			1211					
Travel Time (s)		18.8			27.5					
Peak Hour Factor	1.00	1.00	1.00	1.00	1.00	1.00	1.00	1.00	1.00	1.00
Adj. Flow (vph)	572	875	366	513	1162	1124	285	161	605	671
Shared Lane Traffic (%)										
Lane Group Flow (vph)	572	875	366	513	1162	1124	285	161	605	671
Enter Blocked Intersection	No	No	No	No	No	No	No	No	No	No
Lane Alignment	Left	Left	Right	Left	Left	Right	Left	Right	Left	Right
Median Width(ft)		24			24					
Link Offset(ft)		0			0					
Crosswalk Width(ft)		16			16					
Two way Left Turn Lane										
Headway Factor	1.00	1.00	1.00	1.00	1.00	1.00	1.00	1.00	1.00	1.00
Turning Speed (mph)	15		9	15		9	15	9	15	9
Number of Detectors	1	2	1	1	2	1	1	1	1	1
Detector Template	Left	Thru	Right	Left	Thru	Right	Left	Right	Left	Right
Leading Detector (ft)	20	100	20	20	100	20	20	20	20	20
Trailing Detector (ft)	0	0	0	0	0	0	0	0	0	0
Detector 1 Position(ft)	0	0	0	0	0	0	0	0	0	0
Detector 1 Size(ft)	20	6	20	20	6	20	20	20	20	20
Detector 1 Type	Cl+Ex	Cl+Ex	Cl+Ex	Cl+Ex	Cl+Ex	Cl+Ex	Cl+Ex	Cl+Ex	Cl+Ex	Cl+Ex
Detector 1 Channel										
Detector 1 Extend (s)	0.0	0.0	0.0	0.0	0.0	0.0	0.0	0.0	0.0	0.0
Detector 1 Queue (s)	0.0	0.0	0.0	0.0	0.0	0.0	0.0	0.0	0.0	0.0
Detector 1 Delay (s)	0.0	0.0	0.0	0.0	0.0	0.0	0.0	0.0	0.0	0.0
Detector 2 Position(ft)		94			94					
Detector 2 Size(ft)		6			6					
Detector 2 Type		Cl+Ex			Cl+Ex					
Detector 2 Channel										
Detector 2 Extend (s)		0.0			0.0					
Turn Type	Prot	NA	Free	Prot	NA	Perm	Perm	Free	Perm	Prot
Protected Phases	1	6		5	2					1
Permitted Phases			Free			2	3	Free	7	

Lanes, Volumes, Timings

1: I65 NB off Ramp /I65 SB off ramp & McEwen/McEwen

11/18/2016

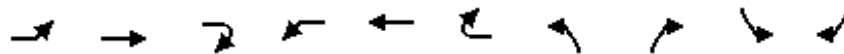

Lane Group	EBL	EBT	EBR2	WBL	WBT	WBR2	NBL	NBR2	SBL	SBR2
Detector Phase	1	6		5	2	2	3		7	1
Switch Phase										
Minimum Initial (s)	8.0	12.0		8.0	12.0	12.0	12.0		12.0	8.0
Minimum Split (s)	15.0	27.0		25.0	27.0	27.0	27.0		27.0	15.0
Total Split (s)	35.0	59.0		59.0	83.0	83.0	32.0		32.0	35.0
Total Split (%)	23.3%	39.3%		39.3%	55.3%	55.3%	21.3%		21.3%	23.3%
Maximum Green (s)	28.0	52.0		52.0	76.0	76.0	25.0		25.0	28.0
Yellow Time (s)	4.0	4.0		4.0	4.0	4.0	4.0		4.0	4.0
All-Red Time (s)	3.0	3.0		3.0	3.0	3.0	3.0		3.0	3.0
Lost Time Adjust (s)	0.0	0.0		0.0	0.0	0.0	0.0		0.0	0.0
Total Lost Time (s)	7.0	7.0		7.0	7.0	7.0	7.0		7.0	7.0
Lead/Lag	Lead	Lag		Lead	Lag	Lag				Lead
Lead-Lag Optimize?										
Vehicle Extension (s)	3.0	3.0		3.0	3.0	3.0	3.0		3.0	3.0
Recall Mode	None	C-Min		None	C-Min	C-Min	None		None	None
Walk Time (s)		7.0			7.0	7.0	7.0		7.0	
Flash Dont Walk (s)		13.0			13.0	13.0	13.0		13.0	
Pedestrian Calls (#/hr)		5			5	5	5		5	
Act Effct Green (s)	28.0	56.6	150.0	47.4	76.0	76.0	25.0	150.0	25.0	28.0
Actuated g/C Ratio	0.19	0.38	1.00	0.32	0.51	0.51	0.17	1.00	0.17	0.19
v/c Ratio	0.89	0.65	0.23	0.92	0.65	1.06	0.50	0.10	1.06	1.07
Control Delay	79.2	42.2	0.3	45.0	25.2	137.9	60.3	0.1	203.5	208.6
Queue Delay	0.0	0.0	0.0	0.0	0.0	0.0	0.0	0.0	0.0	0.0
Total Delay	79.2	42.2	0.3	45.0	25.2	137.9	60.3	0.1	203.5	208.6
LOS	E	D	A	D	C	F	E	A	F	F
Approach Delay		45.4			74.1					
Approach LOS		D			E					
90th %ile Green (s)	28.0	52.0		52.0	76.0	76.0	25.0		25.0	28.0
90th %ile Term Code	Max	Coord		Max	Coord	Coord	Hold		Max	Max
70th %ile Green (s)	28.0	52.0		52.0	76.0	76.0	25.0		25.0	28.0
70th %ile Term Code	Max	Coord		Max	Coord	Coord	Hold		Max	Max
50th %ile Green (s)	28.0	54.5		49.5	76.0	76.0	25.0		25.0	28.0
50th %ile Term Code	Max	Coord		Gap	Coord	Coord	Hold		Max	Max
30th %ile Green (s)	28.0	58.9		45.1	76.0	76.0	25.0		25.0	28.0
30th %ile Term Code	Max	Coord		Gap	Coord	Coord	Hold		Max	Max
10th %ile Green (s)	28.0	65.8		38.2	76.0	76.0	25.0		25.0	28.0
10th %ile Term Code	Max	Coord		Gap	Coord	Coord	Hold		Max	Max
Stops (vph)	537	739	0	449	954	868	255	0	552	504
Fuel Used(gal)	16	17	2	12	22	47	7	1	32	35
CO Emissions (g/hr)	1109	1205	167	840	1552	3282	460	67	2222	2472
NOx Emissions (g/hr)	216	234	32	163	302	639	90	13	432	481
VOC Emissions (g/hr)	257	279	39	195	360	761	107	15	515	573
Dilemma Vehicles (#)	0	0	0	0	0	0	0	0	0	0
Queue Length 50th (ft)	286	404	0	429	510	~1055	132	0	~333	~350
Queue Length 95th (ft)	#471	501	0	m384	m474	m#921	204	0	#540	#593
Internal Link Dist (ft)		746			1131					
Turn Bay Length (ft)	370			495						
Base Capacity (vph)	640	1336	1583	613	1793	1060	572	1583	572	626
Starvation Cap Reductn	0	0	0	0	0	0	0	0	0	0

Lanes, Volumes, Timings

1: I65 NB off Ramp /I65 SB off ramp & McEwen/McEwen

11/18/2016

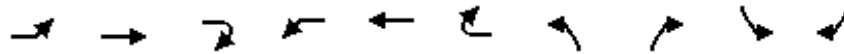

Lane Group	EBL	EBT	EBR2	WBL	WBT	WBR2	NBL	NBR2	SBL	SBR2
Spillback Cap Reductn	0	0	0	0	6	0	0	0	0	0
Storage Cap Reductn	0	0	0	0	0	0	0	0	0	0
Reduced v/c Ratio	0.89	0.65	0.23	0.84	0.65	1.06	0.50	0.10	1.06	1.07

Intersection Summary

Area Type:	Other
Cycle Length:	150
Actuated Cycle Length:	150
Offset:	22 (15%), Referenced to phase 2:WBT and 6:EBT, Start of Yellow
Natural Cycle:	100
Control Type:	Actuated-Coordinated
Maximum v/c Ratio:	1.07
Intersection Signal Delay:	90.0
Intersection LOS:	F
Intersection Capacity Utilization Err%	ICU Level of Service H
Analysis Period (min)	60

~ Volume exceeds capacity, queue is theoretically infinite.

Queue shown is maximum after two cycles.

# 95th percentile volume exceeds capacity, queue may be longer.

Queue shown is maximum after two cycles.

m Volume for 95th percentile queue is metered by upstream signal.

Splits and Phases: 1: I65 NB off Ramp /I65 SB off ramp & McEwen/McEwen

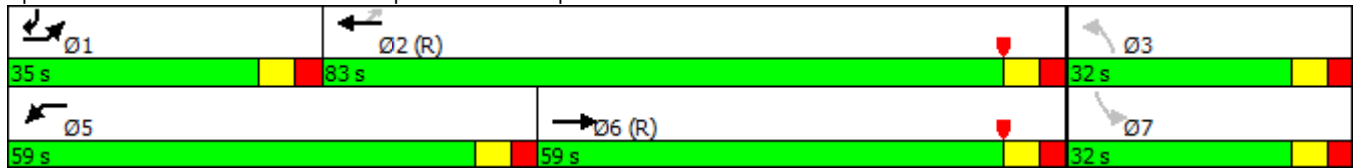

Lanes, Volumes, Timings  
2: McEwen /McEwen & Tower

11/18/2016

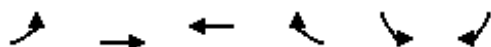

Lane Group	EBL	EBT	WBT	WBR	SBL	SBR
Lane Configurations	↖↖	↗↗	↖↖	↗	↖	↗↗
Traffic Volume (vph)	160	1475	2160	22	170	627
Future Volume (vph)	160	1475	2160	22	170	627
Ideal Flow (vphpl)	1900	1900	1900	1900	1900	1900
Storage Length (ft)	285			115	445	0
Storage Lanes	2			1	1	2
Taper Length (ft)	25				25	
Lane Util. Factor	0.97	0.95	0.95	1.00	1.00	0.88
Fr <sub>t</sub>				0.850		0.850
Fl <sub>t</sub> Protected	0.950				0.950	
Satd. Flow (prot)	3090	3185	3185	1425	1593	2508
Fl <sub>t</sub> Permitted	0.950				0.950	
Satd. Flow (perm)	3090	3185	3185	1425	1593	2508
Right Turn on Red				Yes		Yes
Satd. Flow (RTOR)				6		175
Link Speed (mph)		30	30		30	
Link Distance (ft)		1211	938		511	
Travel Time (s)		27.5	21.3		11.6	
Peak Hour Factor	1.00	1.00	1.00	1.00	1.00	1.00
Adj. Flow (vph)	160	1475	2160	22	170	627
Shared Lane Traffic (%)						
Lane Group Flow (vph)	160	1475	2160	22	170	627
Enter Blocked Intersection	No	No	No	No	No	No
Lane Alignment	Left	Left	Left	Right	Left	Right
Median Width(ft)		24	24		12	
Link Offset(ft)		0	0		0	
Crosswalk Width(ft)		16	16		16	
Two way Left Turn Lane						
Headway Factor	1.14	1.14	1.14	1.14	1.14	1.14
Turning Speed (mph)	15			9	15	9
Number of Detectors	1	2	2	1	1	1
Detector Template	Left	Thru	Thru	Right	Left	Right
Leading Detector (ft)	20	100	100	20	20	20
Trailing Detector (ft)	0	0	0	0	0	0
Detector 1 Position(ft)	0	0	0	0	0	0
Detector 1 Size(ft)	20	6	6	20	20	20
Detector 1 Type	Cl+Ex	Cl+Ex	Cl+Ex	Cl+Ex	Cl+Ex	Cl+Ex
Detector 1 Channel						
Detector 1 Extend (s)	0.0	0.0	0.0	0.0	0.0	0.0
Detector 1 Queue (s)	0.0	0.0	0.0	0.0	0.0	0.0
Detector 1 Delay (s)	0.0	0.0	0.0	0.0	0.0	0.0
Detector 2 Position(ft)		94	94			
Detector 2 Size(ft)		6	6			
Detector 2 Type		Cl+Ex	Cl+Ex			
Detector 2 Channel						
Detector 2 Extend (s)		0.0	0.0			
Turn Type	Prot	NA	NA	Prot	Prot	Prot
Protected Phases	1	6	2	2	8	8
Permitted Phases						

Lanes, Volumes, Timings  
2: McEwen /McEwen & Tower

11/18/2016

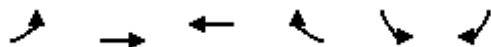

Lane Group	EBL	EBT	WBT	WBR	SBL	SBR
Detector Phase	1	6	2	2	8	8
Switch Phase						
Minimum Initial (s)	7.0	20.0	20.0	20.0	8.0	8.0
Minimum Split (s)	13.5	43.5	43.5	43.5	46.5	46.5
Total Split (s)	13.5	103.5	90.0	90.0	46.5	46.5
Total Split (%)	9.0%	69.0%	60.0%	60.0%	31.0%	31.0%
Maximum Green (s)	8.0	98.0	84.5	84.5	41.0	41.0
Yellow Time (s)	3.5	3.5	3.5	3.5	3.5	3.5
All-Red Time (s)	2.0	2.0	2.0	2.0	2.0	2.0
Lost Time Adjust (s)	0.0	0.0	0.0	0.0	0.0	0.0
Total Lost Time (s)	5.5	5.5	5.5	5.5	5.5	5.5
Lead/Lag	Lead		Lag	Lag		
Lead-Lag Optimize?						
Vehicle Extension (s)	3.0	3.0	3.0	3.0	3.0	3.0
Recall Mode	None	C-Min	C-Min	C-Min	None	None
Walk Time (s)		7.0	7.0	7.0	7.0	7.0
Flash Dont Walk (s)		18.0	18.0	18.0	34.0	34.0
Pedestrian Calls (#/hr)		3	3	3	3	3
Act Effct Green (s)	11.7	105.1	87.9	87.9	33.9	33.9
Actuated g/C Ratio	0.08	0.70	0.59	0.59	0.23	0.23
v/c Ratio	0.67	0.66	1.16	0.03	0.47	0.89
Control Delay	83.5	6.9	309.8	10.4	53.7	59.1
Queue Delay	0.0	0.0	0.0	0.0	0.0	0.5
Total Delay	83.5	6.9	309.8	10.4	53.7	59.6
LOS	F	A	F	B	D	E
Approach Delay		14.4	306.8		58.3	
Approach LOS		B	F		E	
90th %ile Green (s)	8.0	98.0	84.5	84.5	41.0	41.0
90th %ile Term Code	Max	Coord	Coord	Coord	Max	Max
70th %ile Green (s)	10.1	100.1	84.5	84.5	38.9	38.9
70th %ile Term Code	Max	Coord	Coord	Coord	Gap	Gap
50th %ile Green (s)	13.9	103.9	84.5	84.5	35.1	35.1
50th %ile Term Code	Max	Coord	Coord	Coord	Gap	Gap
30th %ile Green (s)	13.9	108.7	89.3	89.3	30.3	30.3
30th %ile Term Code	Gap	Coord	Coord	Coord	Gap	Gap
10th %ile Green (s)	12.4	114.6	96.7	96.7	24.4	24.4
10th %ile Term Code	Gap	Coord	Coord	Coord	Gap	Gap
Stops (vph)	127	848	1642	14	142	455
Fuel Used(gal)	5	21	161	0	3	13
CO Emissions (g/hr)	345	1445	11261	20	232	878
NOx Emissions (g/hr)	67	281	2191	4	45	171
VOC Emissions (g/hr)	80	335	2610	5	54	203
Dilemma Vehicles (#)	0	0	0	0	0	0
Queue Length 50th (ft)	68	433	~1334	4	144	253
Queue Length 95th (ft)	m#134	m517	m#1156	m4	238	#411
Internal Link Dist (ft)		1131	858		431	
Turn Bay Length (ft)	285			115	445	
Base Capacity (vph)	240	2230	1866	837	435	812
Starvation Cap Reductn	0	0	0	0	0	0

Lanes, Volumes, Timings  
 2: McEwen /McEwen & Tower

11/18/2016

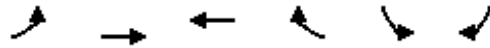

Lane Group	EBL	EBT	WBT	WBR	SBL	SBR
Spillback Cap Reductn	0	0	4	0	0	27
Storage Cap Reductn	0	0	0	0	0	0
Reduced v/c Ratio	0.67	0.66	1.16	0.03	0.39	0.80

Intersection Summary

Area Type: CBD  
 Cycle Length: 150  
 Actuated Cycle Length: 150  
 Offset: 104 (69%), Referenced to phase 2:WBT and 6:EBT, Start of Yellow  
 Natural Cycle: 105  
 Control Type: Actuated-Coordinated  
 Maximum v/c Ratio: 1.16  
 Intersection Signal Delay: 160.2  
 Intersection LOS: F  
 Intersection Capacity Utilization 99.9%  
 ICU Level of Service F  
 Analysis Period (min) 60  
 ~ Volume exceeds capacity, queue is theoretically infinite.  
 Queue shown is maximum after two cycles.  
 # 95th percentile volume exceeds capacity, queue may be longer.  
 Queue shown is maximum after two cycles.  
 m Volume for 95th percentile queue is metered by upstream signal.

Splits and Phases: 2: McEwen /McEwen & Tower

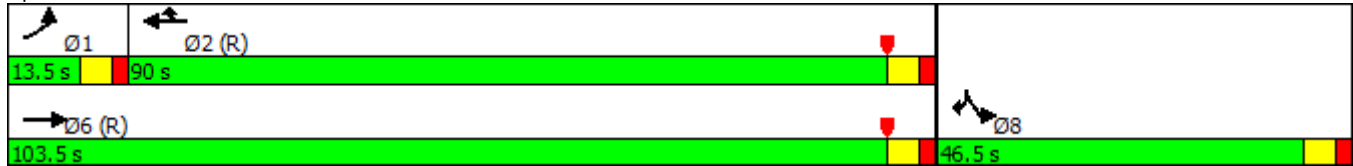



Lanes, Volumes, Timings  
3: Carothers/Carothers & McEwen

11/18/2016



Lane Group	EBL	EBT	EBR	WBL	WBT	WBR	NBL	NBT	NBR	SBL	SBT	SBR
Lane Configurations												
Traffic Volume (vph)	181	872	540	72	749	188	364	385	84	342	1277	1022
Future Volume (vph)	181	872	540	72	749	188	364	385	84	342	1277	1022
Ideal Flow (vphpl)	1900	1900	1900	1900	1900	1900	1900	1900	1900	1900	1900	1900
Storage Length (ft)	205		205	218		97	300		300	280		310
Storage Lanes	2		1	2		1	2		1	2		1
Taper Length (ft)	25			25			25			25		
Lane Util. Factor	0.97	0.95	1.00	0.97	0.95	1.00	0.97	0.95	1.00	0.97	0.95	1.00
Frt			0.850			0.850			0.850			0.850
Flt Protected	0.950			0.950			0.950			0.950		
Satd. Flow (prot)	3433	3539	1583	3433	3539	1583	3433	3539	1583	3433	3539	1583
Flt Permitted	0.950			0.950			0.950			0.950		
Satd. Flow (perm)	3433	3539	1583	3433	3539	1583	3433	3539	1583	3433	3539	1583
Right Turn on Red			Yes			Yes			Yes			Yes
Satd. Flow (RTOR)			62			105			109			65
Link Speed (mph)		30			30			30				40
Link Distance (ft)		938			1960			1936				857
Travel Time (s)		21.3			44.5			44.0				14.6
Peak Hour Factor	1.00	1.00	1.00	1.00	1.00	1.00	1.00	1.00	1.00	1.00	1.00	1.00
Adj. Flow (vph)	181	872	540	72	749	188	364	385	84	342	1277	1022
Shared Lane Traffic (%)												
Lane Group Flow (vph)	181	872	540	72	749	188	364	385	84	342	1277	1022
Enter Blocked Intersection	No	No	No	No	No	No	No	No	No	No	No	No
Lane Alignment	Left	Left	Right	Left	Left	Right	Left	Left	Right	Left	Left	Right
Median Width(ft)		24			24			24				24
Link Offset(ft)		0			0			0				0
Crosswalk Width(ft)		16			16			16				16
Two way Left Turn Lane												
Headway Factor	1.00	1.00	1.00	1.00	1.00	1.00	1.00	1.00	1.00	1.00	1.00	1.00
Turning Speed (mph)	15		9	15		9	15		9	15		9
Number of Detectors	1	2	1	1	2	1	1	2	1	1	2	1
Detector Template	Left	Thru	Right	Left	Thru	Right	Left	Thru	Right	Left	Thru	Right
Leading Detector (ft)	20	100	20	20	100	20	20	100	20	20	100	20
Trailing Detector (ft)	0	0	0	0	0	0	0	0	0	0	0	0
Detector 1 Position(ft)	0	0	0	0	0	0	0	0	0	0	0	0
Detector 1 Size(ft)	20	6	20	20	6	20	20	6	20	20	6	20
Detector 1 Type	Cl+Ex	Cl+Ex	Cl+Ex	Cl+Ex	Cl+Ex	Cl+Ex	Cl+Ex	Cl+Ex	Cl+Ex	Cl+Ex	Cl+Ex	Cl+Ex
Detector 1 Channel												
Detector 1 Extend (s)	0.0	0.0	0.0	0.0	0.0	0.0	0.0	0.0	0.0	0.0	0.0	0.0
Detector 1 Queue (s)	0.0	0.0	0.0	0.0	0.0	0.0	0.0	0.0	0.0	0.0	0.0	0.0
Detector 1 Delay (s)	0.0	0.0	0.0	0.0	0.0	0.0	0.0	0.0	0.0	0.0	0.0	0.0
Detector 2 Position(ft)		94			94			94				94
Detector 2 Size(ft)		6			6			6				6
Detector 2 Type		Cl+Ex			Cl+Ex			Cl+Ex				Cl+Ex
Detector 2 Channel												
Detector 2 Extend (s)		0.0			0.0			0.0				0.0
Turn Type	Prot	NA	pm+ov	Prot	NA	pm+ov	Prot	NA	custom	Prot	NA	custom
Protected Phases	1	6	7	5	2	3	7	4	5	3	8	1
Permitted Phases			6			2			8			4

Lanes, Volumes, Timings  
 3: Carothers/Carothers & McEwen

11/18/2016



Lane Group	EBL	EBT	EBR	WBL	WBT	WBR	NBL	NBT	NBR	SBL	SBT	SBR
Detector Phase	1	6	7	5	2	3	7	4	5	3	8	1
Switch Phase												
Minimum Initial (s)	6.0	13.0	6.0	4.0	13.0	6.0	6.0	13.0	4.0	6.0	13.0	6.0
Minimum Split (s)	13.0	52.0	12.5	10.0	52.0	13.0	12.5	52.0	10.0	13.0	52.0	13.0
Total Split (s)	24.0	66.0	19.0	12.0	54.0	20.0	19.0	52.0	12.0	20.0	53.0	24.0
Total Split (%)	16.0%	44.0%	12.7%	8.0%	36.0%	13.3%	12.7%	34.7%	8.0%	13.3%	35.3%	16.0%
Maximum Green (s)	18.0	60.0	13.0	6.5	48.0	14.0	13.0	46.0	6.5	14.0	47.0	18.0
Yellow Time (s)	4.0	4.0	4.0	3.5	4.0	4.0	4.0	4.0	3.5	4.0	4.0	4.0
All-Red Time (s)	2.0	2.0	2.0	2.0	2.0	2.0	2.0	2.0	2.0	2.0	2.0	2.0
Lost Time Adjust (s)	0.0	0.0	0.0	0.0	0.0	0.0	0.0	0.0	0.0	0.0	0.0	0.0
Total Lost Time (s)	6.0	6.0	6.0	5.5	6.0	6.0	6.0	6.0	5.5	6.0	6.0	6.0
Lead/Lag	Lead	Lag	Lead	Lead	Lag	Lead	Lead	Lag	Lead	Lead	Lag	Lead
Lead-Lag Optimize?												
Vehicle Extension (s)	3.0	3.0	3.0	3.0	3.0	3.0	3.0	3.0	3.0	3.0	3.0	3.0
Recall Mode	Max	C-Max	None	None	C-Max	None	None	None	None	None	None	Max
Walk Time (s)		7.0			7.0			7.0			7.0	
Flash Dont Walk (s)		39.0			39.0			37.0			37.0	
Pedestrian Calls (#/hr)		5			5			5			5	
Act Effct Green (s)	18.0	60.0	79.0	6.5	48.0	68.0	13.0	46.0	59.5	14.0	47.0	70.0
Actuated g/C Ratio	0.12	0.40	0.53	0.04	0.32	0.45	0.09	0.31	0.40	0.09	0.31	0.47
v/c Ratio	0.44	0.62	0.63	0.49	0.66	0.24	1.23	0.35	0.12	1.07	1.15	1.32
Control Delay	64.4	19.5	19.3	74.5	41.8	13.7	490.9	41.6	2.5	245.2	331.9	621.2
Queue Delay	0.0	0.0	0.0	0.0	10.5	0.0	0.0	0.0	0.0	0.0	0.0	0.7
Total Delay	64.4	19.5	19.3	74.5	52.3	13.7	490.9	41.6	2.5	245.2	331.9	622.0
LOS	E	B	B	E	D	B	F	D	A	F	F	F
Approach Delay		24.5			46.7			234.0			432.9	
Approach LOS		C			D			F			F	
90th %ile Green (s)	18.0	60.0	13.0	6.5	48.0	14.0	13.0	46.0	6.5	14.0	47.0	18.0
90th %ile Term Code	MaxR	Coord	Max	Max	Coord	Max	Max	Hold	Max	Max	Max	MaxR
70th %ile Green (s)	18.0	60.0	13.0	6.5	48.0	14.0	13.0	46.0	6.5	14.0	47.0	18.0
70th %ile Term Code	MaxR	Coord	Max	Max	Coord	Max	Max	Hold	Max	Max	Max	MaxR
50th %ile Green (s)	18.0	60.0	13.0	6.5	48.0	14.0	13.0	46.0	6.5	14.0	47.0	18.0
50th %ile Term Code	MaxR	Coord	Max	Max	Coord	Max	Max	Hold	Max	Max	Max	MaxR
30th %ile Green (s)	18.0	60.0	13.0	6.5	48.0	14.0	13.0	46.0	6.5	14.0	47.0	18.0
30th %ile Term Code	MaxR	Coord	Max	Max	Coord	Max	Max	Hold	Max	Max	Max	MaxR
10th %ile Green (s)	18.0	60.2	13.0	6.3	48.0	14.0	13.0	46.0	6.3	14.0	47.0	18.0
10th %ile Term Code	MaxR	Coord	Max	Gap	Coord	Max	Max	Hold	Gap	Max	Max	MaxR
Stops (vph)	156	558	400	70	564	98	327	293	4	308	1172	891
Fuel Used(gal)	5	13	8	3	21	4	44	11	1	22	105	144
CO Emissions (g/hr)	319	904	579	180	1464	275	3053	747	93	1544	7355	10062
NOx Emissions (g/hr)	62	176	113	35	285	54	594	145	18	300	1431	1958
VOC Emissions (g/hr)	74	209	134	42	339	64	708	173	22	358	1704	2332
Dilemma Vehicles (#)	0	0	0	0	0	0	0	0	0	0	37	0
Queue Length 50th (ft)	74	304	331	37	295	52	~225	154	0	~190	~771	~1259
Queue Length 95th (ft)	m125	370	666	m58	426	m99	#386	230	30	#345	#1078	#1790
Internal Link Dist (ft)		858			1880			1856			777	
Turn Bay Length (ft)	205		205	218		97	300		300	280		310
Base Capacity (vph)	411	1416	863	148	1132	775	297	1085	693	320	1108	773
Starvation Cap Reductn	0	0	0	0	0	0	0	0	0	0	0	0

Lanes, Volumes, Timings  
 3: Carothers/Carothers & McEwen

11/18/2016



Lane Group	EBL	EBT	EBR	WBL	WBT	WBR	NBL	NBT	NBR	SBL	SBT	SBR
Spillback Cap Reductn	0	0	0	0	343	0	0	0	0	0	0	73
Storage Cap Reductn	0	0	0	0	0	0	0	0	0	0	0	0
Reduced v/c Ratio	0.44	0.62	0.63	0.49	0.95	0.24	1.23	0.35	0.12	1.07	1.15	1.46

Intersection Summary

Area Type: Other  
 Cycle Length: 150  
 Actuated Cycle Length: 150  
 Offset: 108 (72%), Referenced to phase 2:WBT and 6:EBT, Start of Yellow  
 Natural Cycle: 130  
 Control Type: Actuated-Coordinated  
 Maximum v/c Ratio: 1.32  
 Intersection Signal Delay: 234.4  
 Intersection LOS: F  
 Intersection Capacity Utilization 109.4%  
 ICU Level of Service H  
 Analysis Period (min) 60

- ~ Volume exceeds capacity, queue is theoretically infinite.  
 Queue shown is maximum after two cycles.
- # 95th percentile volume exceeds capacity, queue may be longer.  
 Queue shown is maximum after two cycles.
- m Volume for 95th percentile queue is metered by upstream signal.

Splits and Phases: 3: Carothers/Carothers & McEwen

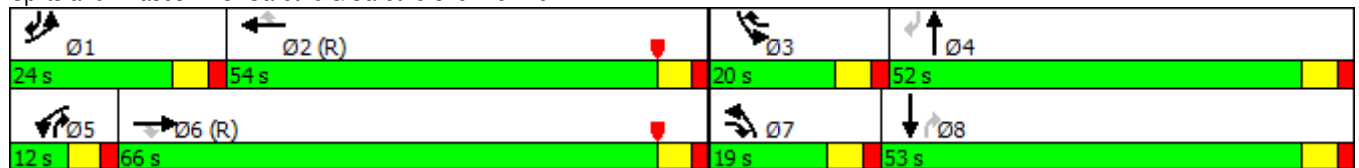

Lanes, Volumes, Timings  
4: Ovation/Resource Parkway & McEwen

11/18/2016



Lane Group	EBL	EBT	EBR	WBL	WBT	WBR	NBL	NBT	NBR	SBL	SBT	SBR
Lane Configurations												
Traffic Volume (vph)	96	1029	181	101	379	16	603	109	86	89	59	112
Future Volume (vph)	96	1029	181	101	379	16	603	109	86	89	59	112
Ideal Flow (vphpl)	1900	1900	1900	1900	1900	1900	1900	1900	1900	1900	1900	1900
Lane Util. Factor	1.00	0.95	1.00	1.00	0.95	0.95	0.97	1.00	1.00	1.00	1.00	1.00
Fr't			0.850		0.994				0.850		0.902	
Flt Protected	0.950			0.950			0.950			0.950		
Satd. Flow (prot)	1770	3539	1583	1770	3518	0	3433	1863	1583	1770	1680	0
Flt Permitted	0.481			0.141			0.458			0.687		
Satd. Flow (perm)	896	3539	1583	263	3518	0	1655	1863	1583	1280	1680	0
Right Turn on Red			Yes			Yes			Yes			Yes
Satd. Flow (RTOR)			181		6				86		112	
Link Speed (mph)		30			30			30			30	
Link Distance (ft)		1960			345			402			456	
Travel Time (s)		44.5			7.8			9.1			10.4	
Peak Hour Factor	1.00	1.00	1.00	1.00	1.00	1.00	1.00	1.00	1.00	1.00	1.00	1.00
Adj. Flow (vph)	96	1029	181	101	379	16	603	109	86	89	59	112
Shared Lane Traffic (%)												
Lane Group Flow (vph)	96	1029	181	101	395	0	603	109	86	89	171	0
Enter Blocked Intersection	No	No	No	No	No	No	No	No	No	No	No	No
Lane Alignment	Left	Left	Right	Left	Left	Right	Left	Left	Right	Left	Left	Right
Median Width(ft)		36			36			24			24	
Link Offset(ft)		0			0			0			0	
Crosswalk Width(ft)		16			16			16			16	
Two way Left Turn Lane												
Headway Factor	1.00	1.00	1.00	1.00	1.00	1.00	1.00	1.00	1.00	1.00	1.00	1.00
Turning Speed (mph)	15		9	15		9	15		9	15		9
Number of Detectors	1	2	1	1	2		1	2	1	1	2	
Detector Template	Left	Thru	Right	Left	Thru		Left	Thru	Right	Left	Thru	
Leading Detector (ft)	20	100	20	20	100		20	100	20	20	100	
Trailing Detector (ft)	0	0	0	0	0		0	0	0	0	0	
Detector 1 Position(ft)	0	0	0	0	0		0	0	0	0	0	
Detector 1 Size(ft)	20	6	20	20	6		20	6	20	20	6	
Detector 1 Type	Cl+Ex	Cl+Ex	Cl+Ex	Cl+Ex	Cl+Ex		Cl+Ex	Cl+Ex	Cl+Ex	Cl+Ex	Cl+Ex	
Detector 1 Channel												
Detector 1 Extend (s)	0.0	0.0	0.0	0.0	0.0		0.0	0.0	0.0	0.0	0.0	
Detector 1 Queue (s)	0.0	0.0	0.0	0.0	0.0		0.0	0.0	0.0	0.0	0.0	
Detector 1 Delay (s)	0.0	0.0	0.0	0.0	0.0		0.0	0.0	0.0	0.0	0.0	
Detector 2 Position(ft)		94			94			94			94	
Detector 2 Size(ft)		6			6			6			6	
Detector 2 Type		Cl+Ex			Cl+Ex			Cl+Ex			Cl+Ex	
Detector 2 Channel												
Detector 2 Extend (s)		0.0			0.0			0.0			0.0	
Turn Type	pm+pt	NA	pm+ov	pm+pt	NA		pm+pt	NA	pm+ov	pm+pt	NA	
Protected Phases	3	8	1	7	4		1	6	7	5	2	
Permitted Phases	8		8	4			6		6	2		
Detector Phase	3	8	1	7	4		1	6	7	5	2	
Switch Phase												
Minimum Initial (s)	4.0	4.0	4.0	4.0	4.0		4.0	4.0	4.0	4.0	4.0	

Lanes, Volumes, Timings  
4: Ovation/Resource Parkway & McEwen

11/18/2016



Lane Group	EBL	EBT	EBR	WBL	WBT	WBR	NBL	NBT	NBR	SBL	SBT	SBR
Minimum Split (s)	10.0	20.0	10.0	10.0	20.0		10.0	20.0	10.0	10.0	20.0	
Total Split (s)	10.0	32.0	13.0	10.0	32.0		13.0	23.0	10.0	10.0	20.0	
Total Split (%)	13.3%	42.7%	17.3%	13.3%	42.7%		17.3%	30.7%	13.3%	13.3%	26.7%	
Maximum Green (s)	6.0	28.0	9.0	6.0	28.0		9.0	19.0	6.0	6.0	16.0	
Yellow Time (s)	3.5	3.5	3.5	3.5	3.5		3.5	3.5	3.5	3.5	3.5	
All-Red Time (s)	0.5	0.5	0.5	0.5	0.5		0.5	0.5	0.5	0.5	0.5	
Lost Time Adjust (s)	0.0	0.0	0.0	0.0	0.0		0.0	0.0	0.0	0.0	0.0	
Total Lost Time (s)	4.0	4.0	4.0	4.0	4.0		4.0	4.0	4.0	4.0	4.0	
Lead/Lag	Lead	Lag	Lead	Lead	Lag		Lead	Lag	Lead	Lead	Lag	
Lead-Lag Optimize?												
Vehicle Extension (s)	3.0	3.0	3.0	3.0	3.0		3.0	3.0	3.0	3.0	3.0	
Recall Mode	None	C-Max	None	None	C-Max		None	Max	None	None	Max	
Walk Time (s)		5.0			5.0			5.0			5.0	
Flash Dont Walk (s)		11.0			11.0			11.0			11.0	
Pedestrian Calls (#/hr)		10			10			10			10	
Act Effect Green (s)	34.8	30.0	43.0	34.8	30.0		28.2	21.0	30.9	21.9	16.0	
Actuated g/C Ratio	0.46	0.40	0.57	0.46	0.40		0.38	0.28	0.41	0.29	0.21	
v/c Ratio	0.20	0.73	0.18	0.42	0.28		0.72	0.21	0.12	0.22	0.38	
Control Delay	7.0	17.1	1.6	15.5	16.4		23.6	23.4	4.3	16.7	12.9	
Queue Delay	0.0	0.0	0.0	0.0	0.0		0.0	0.0	0.0	0.0	0.0	
Total Delay	7.0	17.1	1.6	15.5	16.4		23.6	23.4	4.3	16.7	12.9	
LOS	A	B	A	B	B		C	C	A	B	B	
Approach Delay		14.2			16.2			21.5			14.2	
Approach LOS		B			B			C			B	
90th %ile Green (s)	6.0	28.0	9.0	6.0	28.0		9.0	19.0	6.0	6.0	16.0	
90th %ile Term Code	Max	Coord	Max	Max	Coord		Max	MaxR	Max	Max	MaxR	
70th %ile Green (s)	6.0	28.0	9.0	6.0	28.0		9.0	19.0	6.0	6.0	16.0	
70th %ile Term Code	Max	Coord	Max	Max	Coord		Max	MaxR	Max	Max	MaxR	
50th %ile Green (s)	6.0	28.0	9.0	6.0	28.0		9.0	19.0	6.0	6.0	16.0	
50th %ile Term Code	Max	Coord	Max	Max	Coord		Max	MaxR	Max	Max	MaxR	
30th %ile Green (s)	6.0	28.0	9.0	6.0	28.0		9.0	19.0	6.0	6.0	16.0	
30th %ile Term Code	Max	Coord	Max	Max	Coord		Max	MaxR	Max	Max	MaxR	
10th %ile Green (s)	0.0	38.0	9.0	0.0	38.0		9.0	29.0	0.0	0.0	16.0	
10th %ile Term Code	Skip	Coord	Max	Skip	Coord		Max	MaxR	Skip	Skip	MaxR	
Stops (vph)	30	584	27	51	254		438	83	14	61	60	
Fuel Used(gal)	2	23	3	1	4		7	1	0	1	1	
CO Emissions (g/hr)	124	1575	208	61	264		504	92	30	67	97	
NOx Emissions (g/hr)	24	306	40	12	51		98	18	6	13	19	
VOC Emissions (g/hr)	29	365	48	14	61		117	21	7	16	23	
Dilemma Vehicles (#)	0	0	0	0	0		0	0	0	0	0	
Queue Length 50th (ft)	25	296	5	23	65		104	40	0	26	23	
Queue Length 95th (ft)	m42	m376	m16	53	112		#186	90	32	62	89	
Internal Link Dist (ft)		1880			265			322			376	
Turn Bay Length (ft)												
Base Capacity (vph)	485	1415	984	242	1411		835	521	704	414	446	
Starvation Cap Reductn	0	0	0	0	0		0	0	0	0	0	
Spillback Cap Reductn	0	0	0	0	0		0	0	0	0	0	
Storage Cap Reductn	0	0	0	0	0		0	0	0	0	0	
Reduced v/c Ratio	0.20	0.73	0.18	0.42	0.28		0.72	0.21	0.12	0.21	0.38	

Intersection Summary

Area Type:	Other
Cycle Length:	75
Actuated Cycle Length:	75
Offset:	16 (21%), Referenced to phase 4:WBTL and 8:EBTL, Start of Green
Natural Cycle:	60
Control Type:	Actuated-Coordinated
Maximum v/c Ratio:	0.73
Intersection Signal Delay:	16.6
Intersection LOS:	B
Intersection Capacity Utilization	74.6%
ICU Level of Service	D
Analysis Period (min)	60
#	95th percentile volume exceeds capacity, queue may be longer. Queue shown is maximum after two cycles.
m	Volume for 95th percentile queue is metered by upstream signal.

Splits and Phases: 4: Ovation/Resource Parkway & McEwen

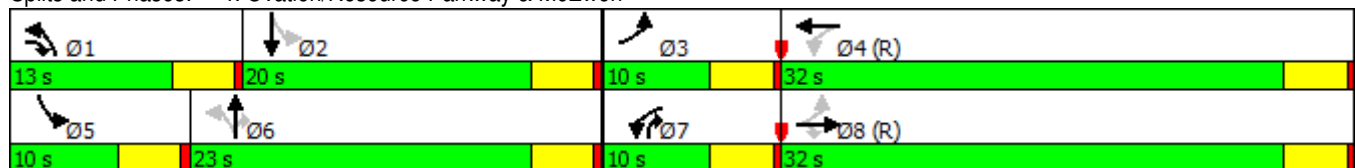

Lanes, Volumes, Timings  
5: Carothers /Carothers & Tower/Pacific

11/18/2016



Lane Group	EBL	EBT	EBR	WBL	WBT	WBR	NBL	NBT	NBR	SBL	SBT	SBR
Lane Configurations	↖↖	↑	↗	↖	↑	↗	↖	↑↑	↗	↖	↑↑	↗
Traffic Volume (vph)	395	1	213	10	0	8	68	667	29	4	2343	120
Future Volume (vph)	395	1	213	10	0	8	68	667	29	4	2343	120
Ideal Flow (vphpl)	1900	1900	1900	1900	1900	1900	1900	1900	1900	1900	1900	1900
Grade (%)		0%			0%			2%			0%	
Storage Length (ft)	84		78	106		77	177		100	85		144
Storage Lanes	2		1	1		1	1		1	1		1
Taper Length (ft)	25			25			25			25		
Lane Util. Factor	0.97	1.00	1.00	1.00	1.00	1.00	1.00	0.95	1.00	1.00	0.95	1.00
Fr <sub>t</sub>			0.850				0.850			0.850		0.850
Fl <sub>t</sub> Protected	0.950			0.950			0.950			0.950		
Satd. Flow (prot)	3433	1863	1583	1770	1863	1583	1752	3504	1567	1770	3539	1583
Fl <sub>t</sub> Permitted	0.950			0.950			0.046			0.385		
Satd. Flow (perm)	3433	1863	1583	1770	1863	1583	85	3504	1567	717	3539	1583
Right Turn on Red			Yes			Yes			Yes			Yes
Satd. Flow (RTOR)			183			204			105			105
Link Speed (mph)		30			30			40			30	
Link Distance (ft)		881			890			857			905	
Travel Time (s)		20.0			20.2			14.6			20.6	
Peak Hour Factor	1.00	1.00	1.00	1.00	1.00	1.00	1.00	1.00	1.00	1.00	1.00	1.00
Adj. Flow (vph)	395	1	213	10	0	8	68	667	29	4	2343	120
Shared Lane Traffic (%)												
Lane Group Flow (vph)	395	1	213	10	0	8	68	667	29	4	2343	120
Enter Blocked Intersection	No	No	No	No	No	No	No	No	No	No	No	No
Lane Alignment	Left	Left	Right	Left	Left	Right	Left	Left	Right	Left	Left	Right
Median Width(ft)		24			24			24			24	
Link Offset(ft)		0			0			0			0	
Crosswalk Width(ft)		16			16			16			16	
Two way Left Turn Lane												
Headway Factor	1.00	1.00	1.00	1.00	1.00	1.00	1.01	1.01	1.01	1.00	1.00	1.00
Turning Speed (mph)	15		9	15		9	15		9	15		9
Number of Detectors	1	2	1	1	2	1	1	2	1	1	2	1
Detector Template	Left	Thru	Right	Left	Thru	Right	Left	Thru	Right	Left	Thru	Right
Leading Detector (ft)	20	100	20	20	100	20	20	100	20	20	100	20
Trailing Detector (ft)	0	0	0	0	0	0	0	0	0	0	0	0
Detector 1 Position(ft)	0	0	0	0	0	0	0	0	0	0	0	0
Detector 1 Size(ft)	20	6	20	20	6	20	20	6	20	20	6	20
Detector 1 Type	Cl+Ex	Cl+Ex	Cl+Ex	Cl+Ex	Cl+Ex	Cl+Ex	Cl+Ex	Cl+Ex	Cl+Ex	Cl+Ex	Cl+Ex	Cl+Ex
Detector 1 Channel												
Detector 1 Extend (s)	0.0	0.0	0.0	0.0	0.0	0.0	0.0	0.0	0.0	0.0	0.0	0.0
Detector 1 Queue (s)	0.0	0.0	0.0	0.0	0.0	0.0	0.0	0.0	0.0	0.0	0.0	0.0
Detector 1 Delay (s)	0.0	0.0	0.0	0.0	0.0	0.0	0.0	0.0	0.0	0.0	0.0	0.0
Detector 2 Position(ft)		94			94			94			94	
Detector 2 Size(ft)		6			6			6			6	
Detector 2 Type		Cl+Ex			Cl+Ex			Cl+Ex			Cl+Ex	
Detector 2 Channel												
Detector 2 Extend (s)		0.0			0.0			0.0			0.0	
Turn Type	Prot	NA	Perm	Prot		Perm	pm+pt	NA	Perm	pm+pt	NA	Perm
Protected Phases	3	8		7	4		1	6		5	2	

Lanes, Volumes, Timings  
5: Carothers /Carothers & Tower/Pacific

11/18/2016



Lane Group	EBL	EBT	EBR	WBL	WBT	WBR	NBL	NBT	NBR	SBL	SBT	SBR
Permitted Phases			8			4	6		6	2		2
Detector Phase	3	8	8	7	4	4	1	6	6	5	2	2
Switch Phase												
Minimum Initial (s)	6.0	8.0	8.0	6.0	8.0	8.0	6.0	20.0	20.0	6.0	20.0	20.0
Minimum Split (s)	12.5	48.5	48.5	12.5	48.5	48.5	12.0	42.0	42.0	12.0	42.0	42.0
Total Split (s)	16.0	52.0	52.0	12.5	48.5	48.5	12.0	63.5	63.5	12.0	63.5	63.5
Total Split (%)	11.4%	37.1%	37.1%	8.9%	34.6%	34.6%	8.6%	45.4%	45.4%	8.6%	45.4%	45.4%
Maximum Green (s)	10.5	46.5	46.5	7.0	43.0	43.0	6.5	57.5	57.5	6.5	57.5	57.5
Yellow Time (s)	3.5	3.5	3.5	3.5	3.5	3.5	3.5	4.0	4.0	3.5	4.0	4.0
All-Red Time (s)	2.0	2.0	2.0	2.0	2.0	2.0	2.0	2.0	2.0	2.0	2.0	2.0
Lost Time Adjust (s)	0.0	0.0	0.0	0.0	0.0	0.0	0.0	0.0	0.0	0.0	0.0	0.0
Total Lost Time (s)	5.5	5.5	5.5	5.5	5.5	5.5	5.5	6.0	6.0	5.5	6.0	6.0
Lead/Lag	Lead	Lag	Lag	Lead	Lag	Lag	Lead	Lag	Lag	Lead	Lag	Lag
Lead-Lag Optimize?												
Vehicle Extension (s)	3.0	3.0	3.0	3.0	3.0	3.0	3.0	3.0	3.0	3.0	3.0	3.0
Recall Mode	None	None	None	None	None	None	None	C-Min	C-Min	None	C-Min	C-Min
Walk Time (s)		7.0	7.0		7.0	7.0		7.0	7.0		7.0	7.0
Flash Dont Walk (s)		36.0	36.0		36.0	36.0		29.0	29.0		29.0	29.0
Pedestrian Calls (#/hr)		10	10		10	10		10	10		10	10
Act Effct Green (s)	10.5	27.4	27.4	6.4		22.0	98.1	96.3	96.3	94.4	89.1	89.1
Actuated g/C Ratio	0.08	0.20	0.20	0.05		0.16	0.70	0.69	0.69	0.67	0.64	0.64
v/c Ratio	1.54	0.00	0.47	0.12		0.02	0.51	0.28	0.03	0.01	1.04	0.11
Control Delay	1027.2	31.0	10.8	67.4		0.1	33.0	14.2	0.0	7.5	97.5	0.6
Queue Delay	0.0	0.0	0.0	0.0		0.0	0.0	0.0	0.0	0.0	0.0	0.0
Total Delay	1027.2	31.0	10.8	67.4		0.1	33.0	14.2	0.0	7.5	97.5	0.6
LOS	F	C	B	E		A	C	B	A	A	F	A
Approach Delay		670.1						15.4			92.6	
Approach LOS		F						B			F	
90th %ile Green (s)	10.5	46.5	46.5	7.0	43.0	43.0	6.5	57.9	57.9	6.1	57.5	57.5
90th %ile Term Code	Max	Hold	Hold	Max	Ped	Ped	Max	Coord	Coord	Gap	Coord	Coord
70th %ile Green (s)	10.5	59.0	59.0	0.0	43.0	43.0	6.5	69.5	69.5	0.0	57.5	57.5
70th %ile Term Code	Max	Hold	Hold	Skip	Ped	Ped	Max	Coord	Coord	Skip	Coord	Coord
50th %ile Green (s)	10.5	10.5	10.5	0.0	0.0	0.0	6.5	118.0	118.0	0.0	106.0	106.0
50th %ile Term Code	Max	Hold	Hold	Skip	Skip	Skip	Gap	Coord	Coord	Skip	Coord	Coord
30th %ile Green (s)	10.5	10.5	10.5	0.0	0.0	0.0	6.0	118.0	118.0	0.0	106.5	106.5
30th %ile Term Code	Max	Hold	Hold	Skip	Skip	Skip	Min	Coord	Coord	Skip	Coord	Coord
10th %ile Green (s)	10.5	10.5	10.5	0.0	0.0	0.0	0.0	118.0	118.0	0.0	118.0	118.0
10th %ile Term Code	Max	Hold	Hold	Skip	Skip	Skip	Skip	Coord	Coord	Skip	Coord	Coord
Stops (vph)	376	1	33	11		0	29	272	0	0	1009	3
Fuel Used(gal)	87	0	2	0		0	1	8	0	0	69	1
CO Emissions (g/hr)	6109	1	148	19		4	79	593	12	2	4796	61
NOx Emissions (g/hr)	1189	0	29	4		1	15	115	2	0	933	12
VOC Emissions (g/hr)	1416	0	34	4		1	18	137	3	1	1112	14
Dilemma Vehicles (#)	0	0	0	0		0	0	24	0	0	0	0
Queue Length 50th (ft)	~259	1	26	9		0	8	47	0	0	79	1
Queue Length 95th (ft)	#421	6	107	32		0	#115	327	0	m1	m#1748	m1
Internal Link Dist (ft)		801			810			777			825	
Turn Bay Length (ft)	84		78	106		77	177		100	85		144
Base Capacity (vph)	257	651	673	88		627	136	2409	1110	534	2252	1045



Lanes, Volumes, Timings  
 5: Carothers /Carothers & Tower/Pacific

11/18/2016



Lane Group	EBL	EBT	EBR	WBL	WBT	WBR	NBL	NBT	NBR	SBL	SBT	SBR
Starvation Cap Reductn	0	0	0	0		0	0	0	0	0	0	0
Spillback Cap Reductn	0	0	0	0		0	0	0	0	0	0	0
Storage Cap Reductn	0	0	0	0		0	0	0	0	0	0	0
Reduced v/c Ratio	1.54	0.00	0.32	0.11		0.01	0.50	0.28	0.03	0.01	1.04	0.11

Intersection Summary

Area Type: Other  
 Cycle Length: 140  
 Actuated Cycle Length: 140  
 Offset: 14 (10%), Referenced to phase 2:SBTL and 6:NBTL, Start of Yellow  
 Natural Cycle: 115  
 Control Type: Actuated-Coordinated  
 Maximum v/c Ratio: 1.54  
 Intersection Signal Delay: 168.2 Intersection LOS: F  
 Intersection Capacity Utilization 97.1% ICU Level of Service F  
 Analysis Period (min) 60  
 ~ Volume exceeds capacity, queue is theoretically infinite.  
 Queue shown is maximum after two cycles.  
 # 95th percentile volume exceeds capacity, queue may be longer.  
 Queue shown is maximum after two cycles.  
 m Volume for 95th percentile queue is metered by upstream signal.

Splits and Phases: 5: Carothers /Carothers & Tower/Pacific

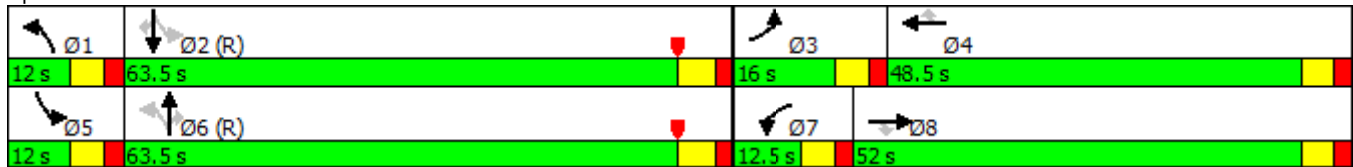

Lanes, Volumes, Timings  
6: Carothers/Carothers Parkway & Apartments/Resource

11/18/2016

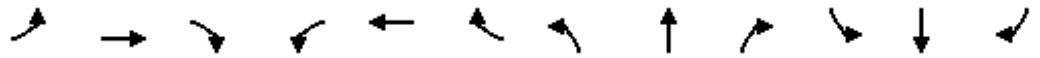

Lane Group	EBL	EBT	EBR	WBL	WBT	WBR	NBL	NBT	NBR	SBL	SBT	SBR
Lane Configurations												
Traffic Volume (vph)	127	0	194	8	0	126	47	1050	3	123	2230	66
Future Volume (vph)	127	0	194	8	0	126	47	1050	3	123	2230	66
Ideal Flow (vphpl)	1900	1900	1900	1900	1900	1900	1900	1900	1900	1900	1900	1900
Grade (%)		0%			0%			2%			0%	
Storage Length (ft)	0		0	0		0	210		128	480		93
Storage Lanes	1		0	1		1	1		0	1		1
Taper Length (ft)	25			25			25			25		
Lane Util. Factor	1.00	1.00	1.00	1.00	1.00	1.00	1.00	0.95	0.95	1.00	0.95	1.00
Fr <sub>t</sub>		0.850				0.850						0.850
Fl <sub>t</sub> Protected	0.950			0.950			0.950			0.950		
Satd. Flow (prot)	1770	1583	0	1770	1863	1583	1752	3504	0	1770	3539	1583
Fl <sub>t</sub> Permitted	0.590			0.518			0.048			0.199		
Satd. Flow (perm)	1099	1583	0	965	1863	1583	89	3504	0	371	3539	1583
Right Turn on Red			Yes			Yes			Yes			Yes
Satd. Flow (RTOR)		194				84						62
Link Speed (mph)		30			30			40				40
Link Distance (ft)		762			773			905				2004
Travel Time (s)		17.3			17.6			15.4				34.2
Peak Hour Factor	1.00	1.00	1.00	1.00	1.00	1.00	1.00	1.00	1.00	1.00	1.00	1.00
Adj. Flow (vph)	127	0	194	8	0	126	47	1050	3	123	2230	66
Shared Lane Traffic (%)												
Lane Group Flow (vph)	127	194	0	8	0	126	47	1053	0	123	2230	66
Enter Blocked Intersection	No	No	No	No	No	No	No	No	No	No	No	No
Lane Alignment	Left	Left	Right	Left	Left	Right	Left	Left	Right	Left	Left	Right
Median Width(ft)		12			12			12				12
Link Offset(ft)		0			0			0				0
Crosswalk Width(ft)		16			16			16				16
Two way Left Turn Lane												
Headway Factor	1.00	1.00	1.00	1.00	1.00	1.00	1.01	1.01	1.01	1.00	1.00	1.00
Turning Speed (mph)	15		9	15		9	15		9	15		9
Number of Detectors	1	2		1	2	1	1	2		1	2	1
Detector Template	Left	Thru		Left	Thru	Right	Left	Thru		Left	Thru	Right
Leading Detector (ft)	20	100		20	100	20	20	100		20	100	20
Trailing Detector (ft)	0	0		0	0	0	0	0		0	0	0
Detector 1 Position(ft)	0	0		0	0	0	0	0		0	0	0
Detector 1 Size(ft)	20	6		20	6	20	20	6		20	6	20
Detector 1 Type	Cl+Ex	Cl+Ex		Cl+Ex	Cl+Ex	Cl+Ex	Cl+Ex	Cl+Ex		Cl+Ex	Cl+Ex	Cl+Ex
Detector 1 Channel												
Detector 1 Extend (s)	0.0	0.0		0.0	0.0	0.0	0.0	0.0		0.0	0.0	0.0
Detector 1 Queue (s)	0.0	0.0		0.0	0.0	0.0	0.0	0.0		0.0	0.0	0.0
Detector 1 Delay (s)	0.0	0.0		0.0	0.0	0.0	0.0	0.0		0.0	0.0	0.0
Detector 2 Position(ft)		94			94			94				94
Detector 2 Size(ft)		6			6			6				6
Detector 2 Type		Cl+Ex			Cl+Ex			Cl+Ex				Cl+Ex
Detector 2 Channel												
Detector 2 Extend (s)		0.0			0.0			0.0				0.0
Turn Type	pm+pt	NA		pm+pt		pm+ov	pm+pt	NA		pm+pt	NA	pm+ov
Protected Phases	3	8		7	4	5	1	6		5	2	3

Lanes, Volumes, Timings  
6: Carothers/Carothers Parkway & Apartments/Resource

11/18/2016



Lane Group	EBL	EBT	EBR	WBL	WBT	WBR	NBL	NBT	NBR	SBL	SBT	SBR
Permitted Phases	8			4		4	6			2		2
Detector Phase	3	8		7	4	5	1	6		5	2	3
Switch Phase												
Minimum Initial (s)	5.0	6.0		5.0	6.0	5.0	5.0	15.0		5.0	15.0	5.0
Minimum Split (s)	12.0	48.5		12.0	48.5	11.5	11.5	48.0		11.5	48.0	12.0
Total Split (s)	12.0	48.5		12.0	48.5	18.2	11.5	61.3		18.2	68.0	12.0
Total Split (%)	8.6%	34.6%		8.6%	34.6%	13.0%	8.2%	43.8%		13.0%	48.6%	8.6%
Maximum Green (s)	6.5	43.0		6.5	43.0	12.7	6.0	55.3		12.7	62.0	6.5
Yellow Time (s)	3.5	3.5		3.5	3.5	3.5	3.5	4.0		3.5	4.0	3.5
All-Red Time (s)	2.0	2.0		2.0	2.0	2.0	2.0	2.0		2.0	2.0	2.0
Lost Time Adjust (s)	0.0	0.0		0.0	0.0	0.0	0.0	0.0		0.0	0.0	0.0
Total Lost Time (s)	5.5	5.5		5.5	5.5	5.5	5.5	6.0		5.5	6.0	5.5
Lead/Lag	Lead	Lag		Lead	Lag	Lead	Lead	Lag		Lead	Lag	Lead
Lead-Lag Optimize?												
Vehicle Extension (s)	3.0	3.0		3.0	3.0	3.0	3.0	3.0		3.0	3.0	3.0
Recall Mode	None	None		None	None	None	None	C-Max		None	C-Max	None
Walk Time (s)		7.0			7.0			7.0			7.0	
Flash Dont Walk (s)		36.0			36.0			35.0			35.0	
Pedestrian Calls (#/hr)		10			10			10			10	
Act Effct Green (s)	24.8	23.5		23.2		28.5	94.3	88.0		101.6	93.5	107.1
Actuated g/C Ratio	0.18	0.17		0.17		0.20	0.67	0.63		0.73	0.67	0.76
v/c Ratio	0.56	0.45		0.04		0.32	0.36	0.48		0.34	0.94	0.05
Control Delay	55.5	7.9		32.8		14.8	31.7	17.5		12.9	35.5	4.1
Queue Delay	0.0	0.0		0.0		0.0	0.0	0.0		0.0	0.0	0.0
Total Delay	55.5	7.9		32.8		14.8	31.7	17.5		12.9	35.5	4.1
LOS	E	A		C		B	C	B		B	D	A
Approach Delay		26.7						18.1			33.5	
Approach LOS		C						B			C	
90th %ile Green (s)	6.5	43.0		6.5	43.0	12.7	6.0	55.3		12.7	62.0	6.5
90th %ile Term Code	Max	Ped		Max	Ped	Max	Max	Coord		Max	Coord	Max
70th %ile Green (s)	6.5	55.0		0.0	43.0	11.7	6.0	56.3		11.7	62.0	6.5
70th %ile Term Code	Max	Hold		Skip	Ped	Gap	Max	Coord		Gap	Coord	Max
50th %ile Green (s)	6.5	6.5		0.0	0.0	8.6	5.9	107.9		8.6	110.6	6.5
50th %ile Term Code	Max	Hold		Skip	Skip	Gap	Gap	Coord		Gap	Coord	Max
30th %ile Green (s)	6.5	6.5		0.0	0.0	6.4	5.7	110.1		6.4	110.8	6.5
30th %ile Term Code	Max	Hold		Skip	Skip	Gap	Gap	Coord		Gap	Coord	Max
10th %ile Green (s)	6.5	6.5		0.0	0.0	6.0	0.0	110.5		6.0	122.0	6.5
10th %ile Term Code	Max	Hold		Skip	Skip	Gap	Skip	Coord		Gap	Coord	Max
Stops (vph)	95	19		7		32	34	501		41	1128	7
Fuel Used(gal)	3	2		0		1	1	15		2	57	1
CO Emissions (g/hr)	190	110		10		92	65	1058		168	4019	71
NOx Emissions (g/hr)	37	21		2		18	13	206		33	782	14
VOC Emissions (g/hr)	44	25		2		21	15	245		39	931	17
Dilemma Vehicles (#)	0	0		0		0	0	24		0	67	0
Queue Length 50th (ft)	~162	0		7		38	5	268		11	516	0
Queue Length 95th (ft)	139	81		18		76	m57	m286		103	#1830	31
Internal Link Dist (ft)		682			693			825			1924	
Turn Bay Length (ft)							210			480		93
Base Capacity (vph)	225	644		200		427	131	2203		400	2362	1225

Lanes, Volumes, Timings  
 6: Carothers/Carothers Parkway & Apartments/Resource

11/18/2016

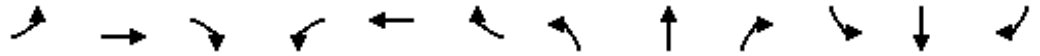

Lane Group	EBL	EBT	EBR	WBL	WBT	WBR	NBL	NBT	NBR	SBL	SBT	SBR
Starvation Cap Reductn	0	0		0		0	0	0		0	0	0
Spillback Cap Reductn	0	0		0		0	0	0		0	0	0
Storage Cap Reductn	0	0		0		0	0	0		0	0	0
Reduced v/c Ratio	0.56	0.30		0.04		0.30	0.36	0.48		0.31	0.94	0.05

Intersection Summary

Area Type: Other  
 Cycle Length: 140  
 Actuated Cycle Length: 140  
 Offset: 0 (0%), Referenced to phase 2:SBTL and 6:NBTL, Start of Yellow  
 Natural Cycle: 120  
 Control Type: Actuated-Coordinated  
 Maximum v/c Ratio: 0.94  
 Intersection Signal Delay: 28.1      Intersection LOS: C  
 Intersection Capacity Utilization 93.7%      ICU Level of Service F  
 Analysis Period (min) 60  
 ~ Volume exceeds capacity, queue is theoretically infinite.  
 Queue shown is maximum after two cycles.  
 # 95th percentile volume exceeds capacity, queue may be longer.  
 Queue shown is maximum after two cycles.  
 m Volume for 95th percentile queue is metered by upstream signal.

Splits and Phases: 6: Carothers/Carothers Parkway & Apartments/Resource

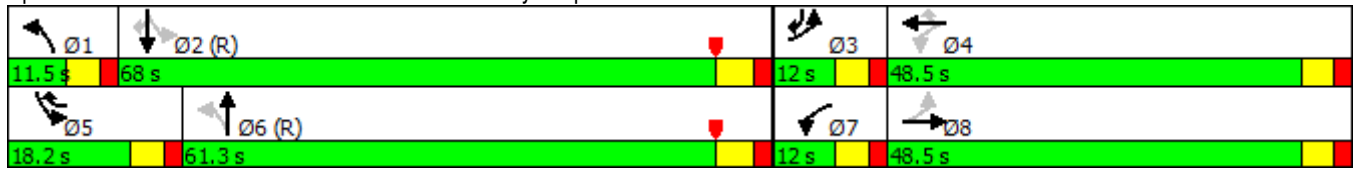

# HCS 2010 Two-Way Stop Control Summary Report

General Information		Site Information	
Analyst	FTG	Intersection	Resource and Pacific
Agency/Co.	FTG	Jurisdiction	Franklin, TN
Date Performed	Nov	East/West Street	Pacific Drive
Analysis Year	2016	North/South Street	Resource Drive
Time Analyzed	AM Peak Hour	Peak Hour Factor	0.92
Intersection Orientation	North-South	Analysis Time Period (hrs)	0.25
Project Description	10765 (Background)		

## Lanes

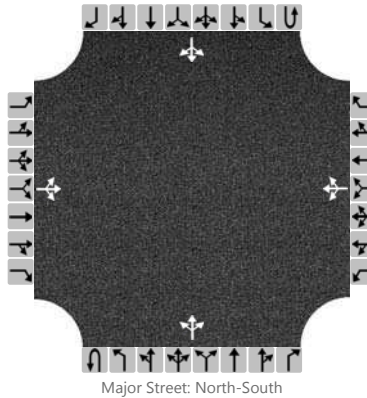

## Vehicle Volumes and Adjustments

Approach	Eastbound				Westbound				Northbound				Southbound				
	U	L	T	R	U	L	T	R	U	L	T	R	U	L	T	R	
Movement																	
Priority		10	11	12		7	8	9	1U	1	2	3	4U	4	5	6	
Number of Lanes		0	1	0		0	1	0	0	0	1	0	0	0	1	0	
Configuration			LTR				LTR				LTR				LTR		
Volume (veh/h)		2	4	3		5	11	10		21	58	0		1	88	11	
Percent Heavy Vehicles		0	0	0		0	0	0		0				0			
Proportion Time Blocked																	
Right Turn Channelized	No				No				No				No				
Median Type	Undivided																
Median Storage																	

## Delay, Queue Length, and Level of Service

Flow Rate (veh/h)			9				28				23					1	
Capacity			759				786				1495					1553	
v/c Ratio			0.01				0.04				0.02					0.00	
95% Queue Length			0.0				0.1				0.0					0.0	
Control Delay (s/veh)			9.8				9.8				7.4					7.3	
Level of Service (LOS)			A				A				A					A	
Approach Delay (s/veh)	9.8				9.8				2.1				0.1				
Approach LOS	A				A				A				A				

# HCS 2010 Two-Way Stop Control Summary Report

General Information		Site Information	
Analyst	FTG	Intersection	Resource and Pacific
Agency/Co.	FTG	Jurisdiction	Franklin, TN
Date Performed	Nov	East/West Street	Pacific Drive
Analysis Year	2016	North/South Street	Resource Drive
Time Analyzed	PM Peak Hour	Peak Hour Factor	0.92
Intersection Orientation	North-South	Analysis Time Period (hrs)	0.25
Project Description	10765 (Background)		

## Lanes

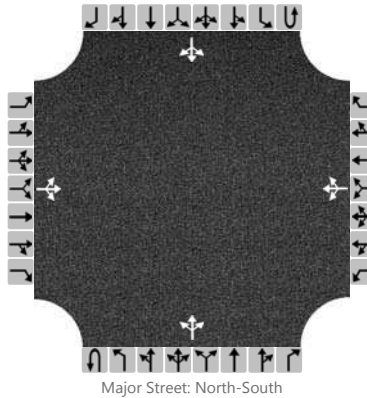

## Vehicle Volumes and Adjustments

Approach	Eastbound				Westbound				Northbound				Southbound			
	U	L	T	R	U	L	T	R	U	L	T	R	U	L	T	R
Movement																
Priority		10	11	12		7	8	9	1U	1	2	3	4U	4	5	6
Number of Lanes		0	1	0		0	1	0	0	0	1	0	0	0	1	0
Configuration			LTR				LTR				LTR				LTR	
Volume (veh/h)		4	4	26		6	4	1		9	119	1		12	85	5
Percent Heavy Vehicles		0	0	0		0	0	0		0				0		
Proportion Time Blocked																
Right Turn Channelized	No				No				No				No			
Median Type	Undivided															
Median Storage																

## Delay, Queue Length, and Level of Service

Flow Rate (veh/h)			36				12				10				13		
Capacity			873				652				1509				1468		
v/c Ratio			0.04				0.02				0.01				0.01		
95% Queue Length			0.1				0.1				0.0				0.0		
Control Delay (s/veh)			9.3				10.6				7.4				7.5		
Level of Service (LOS)			A				B				A				A		
Approach Delay (s/veh)	9.3				10.6				0.6				0.9				
Approach LOS	A				B				A				A				

# HCS 2010 Two-Way Stop Control Summary Report

General Information		Site Information	
Analyst	FTG	Intersection	Resource and Terrapin
Agency/Co.	FTG	Jurisdiction	Franklin, TN
Date Performed	Nov	East/West Street	Terrapin St
Analysis Year	2016	North/South Street	Resource Drive
Time Analyzed	AM Peak Hour	Peak Hour Factor	0.92
Intersection Orientation	North-South	Analysis Time Period (hrs)	0.25
Project Description	10765 (Background)		

## Lanes

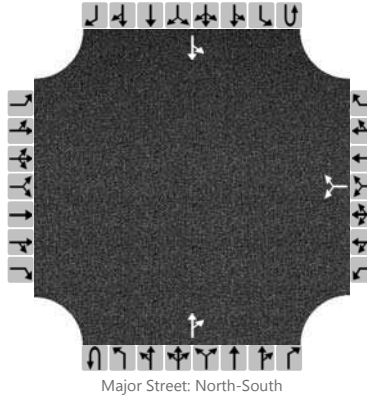

## Vehicle Volumes and Adjustments

Approach	Eastbound				Westbound				Northbound				Southbound			
	U	L	T	R	U	L	T	R	U	L	T	R	U	L	T	R
Movement																
Priority		10	11	12		7	8	9	1U	1	2	3	4U	4	5	6
Number of Lanes		0	0	0		0	0	0		0	1	0		0	1	0
Configuration							LR					TR		LT		
Volume (veh/h)						9		20			59	2		2	94	
Percent Heavy Vehicles						0		0						0		
Proportion Time Blocked																
Right Turn Channelized	No				No				No				No			
Median Type	Undivided															
Median Storage																

## Delay, Queue Length, and Level of Service

Flow Rate (veh/h)							32								104		
Capacity							929								1549		
v/c Ratio							0.03								0.07		
95% Queue Length							0.1								0.0		
Control Delay (s/veh)							9.0								7.3		
Level of Service (LOS)							A								A		
Approach Delay (s/veh)					9.0								0.2				
Approach LOS					A								A				

# HCS 2010 Two-Way Stop Control Summary Report

General Information		Site Information	
Analyst	FTG	Intersection	Resource and Terrapin
Agency/Co.	FTG	Jurisdiction	Franklin, TN
Date Performed	Nov	East/West Street	Terrapin St
Analysis Year	2016	North/South Street	Resource Drive
Time Analyzed	PM Peak Hour	Peak Hour Factor	0.92
Intersection Orientation	North-South	Analysis Time Period (hrs)	0.25
Project Description	10765 (Background)		

## Lanes

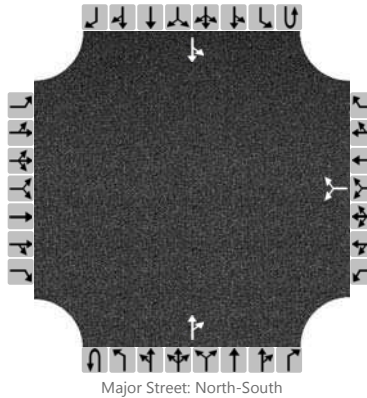

## Vehicle Volumes and Adjustments

Approach	Eastbound				Westbound				Northbound				Southbound			
	U	L	T	R	U	L	T	R	U	L	T	R	U	L	T	R
Movement																
Priority		10	11	12		7	8	9	1U	1	2	3	4U	4	5	6
Number of Lanes		0	0	0		0	0	0	0	0	1	0	0	0	1	0
Configuration							LR					TR		LT		
Volume (veh/h)						7		6			123	6		13	104	
Percent Heavy Vehicles						0		0						0		
Proportion Time Blocked																
Right Turn Channelized	No				No				No				No			
Median Type	Undivided															
Median Storage																

## Delay, Queue Length, and Level of Service

Flow Rate (veh/h)							15								127		
Capacity							768								1455		
v/c Ratio							0.02								0.09		
95% Queue Length							0.1								0.0		
Control Delay (s/veh)							9.8								7.5		
Level of Service (LOS)							A								A		
Approach Delay (s/veh)					9.8								0.9				
Approach LOS					A								A				



Phone:  
E-Mail:

Fax:

-----                    ROUNDBOUT ANALYSIS                    -----

Analyst: FTG  
 Agency/Co.: FTG  
 Date Performed: Nov 2016  
 Analysis Time Period: AM Peak Hour  
 Intersection: Resource and Lemon Grass  
 Jurisdiction: Franklin, TN  
 Units: U. S. Customary  
 Analysis Year: 2016 (Background)  
 Project ID: 10765  
 East/West Street: Resource Drive  
 North/South Street: Lemon Grass Drive

-----                    Volume Adjustments and Site Characteristics                    -----

	Eastbound			Westbound			Northbound			Southbound		
	L	T	R	L	T	R	L	T	R	L	T	R
Volume	0	103			50	148				22		11
U-Turn Vol	0			0			0			0		
% Thrus Left Lane	Eastbound			Westbound			Northbound			Southbound		
Lane Assn.	Left Right BP			Left Right BP			Left Right BP			Left Right BP		
RT Bypass	LT			TR			LR			LR		
PHF	0.92	0.92	0.92	0.92	0.92	0.92	0.92	0.92	0.92	0.92	0.92	0.92
%HV	0	0	0	0	0	0	0	0	0	0	0	0
NumPeds	0			0			0			0		
U-Turn PHF	0.92			0.92			0.92			0.92		
U-Turn %HV	3			3			3			3		
Flow Rate	0	112	0	0	54	161	0	0	0	24	0	12
No. Lanes	0	1	0	0	1	0	0	0	0	0	0	0
Cnfl. Lanes	1			1			1			1		
Duration, T	0.25 hrs.											

-----                    Critical and Follow-Up Headway Adjustment                    -----

Crit. Hdwy	5.1929	Eastbound			Westbound			Northbound			Southbound		
		5.1929	5.1929	5.1929	5.1929	5.1929	5.1929	5.1929	5.1929	5.1929	5.1929	5.1929	
Crit. Hdwy	5.1929	Northbound			Southbound			Northbound			Southbound		
		5.1929	5.1929	5.1929	5.1929	5.1929	5.1929	5.1929	5.1929	5.1929	5.1929	5.1929	
Flup. Hdwy	3.1858	Eastbound			Westbound			Northbound			Southbound		
		3.1858	3.1858	3.1858	3.1858	3.1858	3.1858	3.1858	3.1858	3.1858	3.1858	3.1858	
Flup. Hdwy	3.1858	Northbound			Southbound			Northbound			Southbound		
		3.1858	3.1858	3.1858	3.1858	3.1858	3.1858	3.1858	3.1858	3.1858	3.1858	3.1858	

-----                    Flow Computations                    -----

	Eastbound	Westbound	Northbound	Southbound
Circ. Flow	24	0	136	54
Exit. Flow	136	66	161	0

-----                    Capacity and Level of Service                    -----

Eastbound                      Westbound                      Northbound                      Southbound

	Left	Right	BP	Left	Right	BP	Left	Right	BP	Left	Right	BP
Entry Flow		112			215			25			36	
Entry Cap.		1103			1130			0			1070	
Volume (vph)		112			215						36	
Cap. (vph)		1103			1130			0			1070	
v/c Ratio		0.10			0.19						0.03	
Critical Lane		*			*						*	
Lane Delay		4.1			4.9						3.6	
Lane LOS		A			A			F			A	
95 % Queue		0.3			0.7						0.1	
Approach:												
Delay		4.14			4.88						3.65	
LOS		A			A						A	
Intersection Delay		4.53						Intersection LOS			A	

---

Phone:  
E-Mail:

Fax:

-----                    ROUNDBOUT ANALYSIS                    -----

Analyst: FTG  
 Agency/Co.: FTG  
 Date Performed: Nov 2016  
 Analysis Time Period: PM Peak Hour  
 Intersection: Resource and Lemon Grass  
 Jurisdiction: Franklin, TN  
 Units: U. S. Customary  
 Analysis Year: 2016 (Background)  
 Project ID: 10765  
 East/West Street: Resource Drive  
 North/South Street: Lemon Grass Drive

-----                    Volume Adjustments and Site Characteristics                    -----

	Eastbound			Westbound			Northbound			Southbound		
	L	T	R	L	T	R	L	T	R	L	T	R
Volume	13	98			119	34				149		10
U-Turn Vol	0			0			0			0		
% Thrus Left Lane	Eastbound			Westbound			Northbound			Southbound		
Lane Assn.	Left Right BP			Left Right BP			Left Right BP			Left Right BP		
RT Bypass	LT			TR			LR			LR		
PHF	0.92	0.92	0.92	0.92	0.92	0.92	0.92	0.92	0.92	0.92	0.92	0.92
%HV	0	0	0	0	0	0	0	0	0	0	0	0
NumPeds	0			0			0			0		
U-Turn PHF	0.92			0.92			0.92			0.92		
U-Turn %HV	3			3			3			3		
Flow Rate	14	107	0	0	129	37	0	0	0	162	0	11
No. Lanes	0	1	0	0	1	0	0	0	0	0	0	0
Cnfl. Lanes	1			1			1			1		
Duration, T	0.25 hrs.											

-----                    Critical and Follow-Up Headway Adjustment                    -----

Crit. Hdwy	5.1929	Eastbound			Westbound			Northbound			Southbound		
		5.1929	5.1929	5.1929	5.1929	5.1929	5.1929	5.1929	5.1929	5.1929	5.1929	5.1929	
Crit. Hdwy	5.1929	Northbound			Southbound			Northbound			Southbound		
		5.1929	5.1929	5.1929	5.1929	5.1929	5.1929	5.1929	5.1929	5.1929	5.1929	5.1929	
Flup. Hdwy	3.1858	Eastbound			Westbound			Northbound			Southbound		
		3.1858	3.1858	3.1858	3.1858	3.1858	3.1858	3.1858	3.1858	3.1858	3.1858	3.1858	
Flup. Hdwy	3.1858	Northbound			Southbound			Northbound			Southbound		
		3.1858	3.1858	3.1858	3.1858	3.1858	3.1858	3.1858	3.1858	3.1858	3.1858	3.1858	

-----                    Flow Computations                    -----

	Eastbound	Westbound	Northbound	Southbound
Circ. Flow	162	14	283	129
Exit. Flow	268	140	51	0

-----                    Capacity and Level of Service                    -----

Eastbound                      Westbound                      Northbound                      Southbound

	Left	Right	BP	Left	Right	BP	Left	Right	BP	Left	Right	BP
Entry Flow		121			166			109			173	
Entry Cap.		961			1114			0			993	
Volume (vph)		121			166						173	
Cap. (vph)		961			1114			0			993	
v/c Ratio		0.13			0.15						0.17	
Critical Lane		*			*						*	
Lane Delay		4.9			4.5						5.3	
Lane LOS		A			A			F			A	
95 % Queue		0.4			0.5						0.6	
Approach:												
Delay		4.91			4.54						5.26	
LOS		A			A						A	
Intersection Delay		4.91						Intersection LOS				A

---

**TOTAL PROJECTED CONDITIONS**

Lanes, Volumes, Timings

1: I65 NB off Ramp /I65 SB off ramp & McEwen/McEwen

11/18/2016

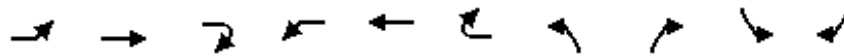

Lane Group	EBL	EBT	EBR2	WBL	WBT	WBR2	NBL	NBR2	SBL	SBR2
Lane Configurations										
Traffic Volume (vph)	480	913	117	199	755	506	614	991	793	372
Future Volume (vph)	480	913	117	199	755	506	614	991	793	372
Ideal Flow (vphpl)	1900	1900	1900	1900	1900	1900	1900	1900	1900	1900
Storage Length (ft)	370			495			0		0	
Storage Lanes	2			1			2		2	
Taper Length (ft)	25			25			25		25	
Lane Util. Factor	0.97	0.95	1.00	1.00	0.95	1.00	0.97	1.00	0.97	0.88
Frt			0.850			0.850		0.850		0.850
Flt Protected	0.950			0.950			0.950		0.950	
Satd. Flow (prot)	3433	3539	1583	1770	3539	1583	3433	1583	3433	2787
Flt Permitted	0.950			0.950			0.950		0.950	
Satd. Flow (perm)	3433	3539	1583	1770	3539	1583	3433	1583	3433	2787
Right Turn on Red			Yes			Yes		Yes		Yes
Satd. Flow (RTOR)			131			506		270		119
Link Speed (mph)		30			30					
Link Distance (ft)		826			1211					
Travel Time (s)		18.8			27.5					
Peak Hour Factor	1.00	1.00	1.00	1.00	1.00	1.00	1.00	1.00	1.00	1.00
Adj. Flow (vph)	480	913	117	199	755	506	614	991	793	372
Shared Lane Traffic (%)										
Lane Group Flow (vph)	480	913	117	199	755	506	614	991	793	372
Enter Blocked Intersection	No	No	No	No	No	No	No	No	No	No
Lane Alignment	Left	Left	Right	Left	Left	Right	Left	Right	Left	Right
Median Width(ft)		24			24					
Link Offset(ft)		0			0					
Crosswalk Width(ft)		16			16					
Two way Left Turn Lane										
Headway Factor	1.00	1.00	1.00	1.00	1.00	1.00	1.00	1.00	1.00	1.00
Turning Speed (mph)	15		9	15		9	15	9	15	9
Number of Detectors	1	2	1	1	2	1	1	1	1	1
Detector Template	Left	Thru	Right	Left	Thru	Right	Left	Right	Left	Right
Leading Detector (ft)	20	100	20	20	100	20	20	20	20	20
Trailing Detector (ft)	0	0	0	0	0	0	0	0	0	0
Detector 1 Position(ft)	0	0	0	0	0	0	0	0	0	0
Detector 1 Size(ft)	20	6	20	20	6	20	20	20	20	20
Detector 1 Type	Cl+Ex	Cl+Ex	Cl+Ex	Cl+Ex	Cl+Ex	Cl+Ex	Cl+Ex	Cl+Ex	Cl+Ex	Cl+Ex
Detector 1 Channel										
Detector 1 Extend (s)	0.0	0.0	0.0	0.0	0.0	0.0	0.0	0.0	0.0	0.0
Detector 1 Queue (s)	0.0	0.0	0.0	0.0	0.0	0.0	0.0	0.0	0.0	0.0
Detector 1 Delay (s)	0.0	0.0	0.0	0.0	0.0	0.0	0.0	0.0	0.0	0.0
Detector 2 Position(ft)		94			94					
Detector 2 Size(ft)		6			6					
Detector 2 Type		Cl+Ex			Cl+Ex					
Detector 2 Channel										
Detector 2 Extend (s)		0.0			0.0					
Turn Type	Prot	NA	Free	Prot	NA	Perm	Perm	Free	Perm	Prot
Protected Phases	1	6		5	2					1
Permitted Phases			Free			2	3	Free	7	

Lanes, Volumes, Timings

1: I65 NB off Ramp /I65 SB off ramp & McEwen/McEwen

11/18/2016

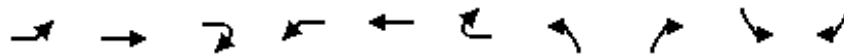

Lane Group	EBL	EBT	EBR2	WBL	WBT	WBR2	NBL	NBR2	SBL	SBR2
Detector Phase	1	6		5	2	2	3		7	1
Switch Phase										
Minimum Initial (s)	8.0	12.0		8.0	12.0	12.0	12.0		12.0	8.0
Minimum Split (s)	15.0	27.0		25.0	27.0	27.0	27.0		27.0	15.0
Total Split (s)	38.0	61.0		35.0	58.0	58.0	54.0		54.0	38.0
Total Split (%)	25.3%	40.7%		23.3%	38.7%	38.7%	36.0%		36.0%	25.3%
Maximum Green (s)	31.0	54.0		28.0	51.0	51.0	47.0		47.0	31.0
Yellow Time (s)	4.0	4.0		4.0	4.0	4.0	4.0		4.0	4.0
All-Red Time (s)	3.0	3.0		3.0	3.0	3.0	3.0		3.0	3.0
Lost Time Adjust (s)	0.0	0.0		0.0	0.0	0.0	0.0		0.0	0.0
Total Lost Time (s)	7.0	7.0		7.0	7.0	7.0	7.0		7.0	7.0
Lead/Lag	Lead	Lag		Lead	Lag	Lag				Lead
Lead-Lag Optimize?										
Vehicle Extension (s)	3.0	3.0		3.0	3.0	3.0	3.0		3.0	3.0
Recall Mode	None	C-Min		None	C-Min	C-Min	None		None	None
Walk Time (s)		7.0			7.0	7.0	7.0		7.0	
Flash Dont Walk (s)		13.0			13.0	13.0	13.0		13.0	
Pedestrian Calls (#/hr)		5			5	5	5		5	
Act Effct Green (s)	26.4	66.9	150.0	21.8	62.2	62.2	40.4	150.0	40.4	26.4
Actuated g/C Ratio	0.18	0.45	1.00	0.15	0.41	0.41	0.27	1.00	0.27	0.18
v/c Ratio	0.79	0.58	0.07	0.78	0.51	0.53	0.66	0.63	0.86	0.63
Control Delay	70.3	30.0	0.1	95.2	22.3	3.6	52.2	1.9	63.0	43.1
Queue Delay	0.0	0.0	0.0	0.0	0.0	0.0	0.0	0.0	0.0	0.0
Total Delay	70.3	30.0	0.1	95.2	22.3	3.6	52.2	1.9	63.0	43.1
LOS	E	C	A	F	C	A	D	A	E	D
Approach Delay		40.5			25.7					
Approach LOS		D			C					
90th %ile Green (s)	31.0	54.0		28.0	51.0	51.0	47.0		47.0	31.0
90th %ile Term Code	Max	Coord		Max	Coord	Coord	Hold		Max	Max
70th %ile Green (s)	29.3	60.3		25.0	56.0	56.0	43.7		43.7	29.3
70th %ile Term Code	Gap	Coord		Gap	Coord	Coord	Hold		Gap	Gap
50th %ile Green (s)	27.0	66.1		22.1	61.2	61.2	40.8		40.8	27.0
50th %ile Term Code	Gap	Coord		Gap	Coord	Coord	Hold		Gap	Gap
30th %ile Green (s)	24.6	72.1		19.1	66.6	66.6	37.8		37.8	24.6
30th %ile Term Code	Gap	Coord		Gap	Coord	Coord	Hold		Gap	Gap
10th %ile Green (s)	20.2	81.8		14.6	76.2	76.2	32.6		32.6	20.2
10th %ile Term Code	Gap	Coord		Gap	Coord	Coord	Hold		Gap	Gap
Stops (vph)	457	635	0	201	297	84	531	1	736	234
Fuel Used(gal)	12	15	1	7	12	6	13	6	19	7
CO Emissions (g/hr)	873	1046	53	479	852	392	914	435	1333	477
NOx Emissions (g/hr)	170	204	10	93	166	76	178	85	259	93
VOC Emissions (g/hr)	202	243	12	111	198	91	212	101	309	111
Dilemma Vehicles (#)	0	0	0	0	0	0	0	0	0	0
Queue Length 50th (ft)	235	357	0	206	105	33	276	0	380	131
Queue Length 95th (ft)	344	365	0	m262	m182	m100	370	0	504	221
Internal Link Dist (ft)		746			1131					
Turn Bay Length (ft)	370			495						
Base Capacity (vph)	709	1577	1583	330	1467	952	1075	1583	1075	670
Starvation Cap Reductn	0	0	0	0	0	0	0	0	0	0

Lanes, Volumes, Timings

1: I65 NB off Ramp /I65 SB off ramp & McEwen/McEwen

11/18/2016

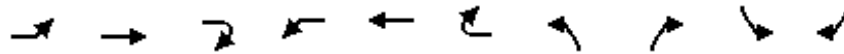

Lane Group	EBL	EBT	EBR2	WBL	WBT	WBR2	NBL	NBR2	SBL	SBR2
Spillback Cap Reductn	0	0	0	0	0	0	0	0	0	0
Storage Cap Reductn	0	0	0	0	0	0	0	0	0	0
Reduced v/c Ratio	0.68	0.58	0.07	0.60	0.51	0.53	0.57	0.63	0.74	0.56

Intersection Summary

Area Type:	Other
Cycle Length:	150
Actuated Cycle Length:	150
Offset:	98 (65%), Referenced to phase 2:WBT and 6:EBT, Start of Yellow
Natural Cycle:	80
Control Type:	Actuated-Coordinated
Maximum v/c Ratio:	0.86
Intersection Signal Delay:	34.6
Intersection LOS:	C
Intersection Capacity Utilization Err%	ICU Level of Service H
Analysis Period (min)	60

m Volume for 95th percentile queue is metered by upstream signal.

Splits and Phases: 1: I65 NB off Ramp /I65 SB off ramp & McEwen/McEwen





Lanes, Volumes, Timings  
2: McEwen /McEwen & Tower

11/18/2016

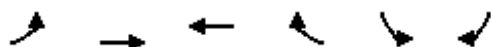

Lane Group	EBL	EBT	WBT	WBR	SBL	SBR
Lane Configurations	↗↗	↑↑	↑↑	↖	↘	↘↘
Traffic Volume (vph)	632	2117	1386	114	19	98
Future Volume (vph)	632	2117	1386	114	19	98
Ideal Flow (vphpl)	1900	1900	1900	1900	1900	1900
Storage Length (ft)	285			115	445	0
Storage Lanes	2			1	1	2
Taper Length (ft)	25				25	
Lane Util. Factor	0.97	0.95	0.95	1.00	1.00	0.88
Fr <sub>t</sub>				0.850		0.850
Fl <sub>t</sub> Protected	0.950				0.950	
Satd. Flow (prot)	3090	3185	3185	1425	1593	2508
Fl <sub>t</sub> Permitted	0.950				0.950	
Satd. Flow (perm)	3090	3185	3185	1425	1593	2508
Right Turn on Red				Yes		Yes
Satd. Flow (RTOR)				36		98
Link Speed (mph)		30	30		30	
Link Distance (ft)		1211	938		511	
Travel Time (s)		27.5	21.3		11.6	
Peak Hour Factor	1.00	1.00	1.00	1.00	1.00	1.00
Adj. Flow (vph)	632	2117	1386	114	19	98
Shared Lane Traffic (%)						
Lane Group Flow (vph)	632	2117	1386	114	19	98
Enter Blocked Intersection	No	No	No	No	No	No
Lane Alignment	Left	Left	Left	Right	Left	Right
Median Width(ft)		24	24		12	
Link Offset(ft)		0	0		0	
Crosswalk Width(ft)		16	16		16	
Two way Left Turn Lane						
Headway Factor	1.14	1.14	1.14	1.14	1.14	1.14
Turning Speed (mph)	15			9	15	9
Number of Detectors	1	2	2	1	1	1
Detector Template	Left	Thru	Thru	Right	Left	Right
Leading Detector (ft)	20	100	100	20	20	20
Trailing Detector (ft)	0	0	0	0	0	0
Detector 1 Position(ft)	0	0	0	0	0	0
Detector 1 Size(ft)	20	6	6	20	20	20
Detector 1 Type	Cl+Ex	Cl+Ex	Cl+Ex	Cl+Ex	Cl+Ex	Cl+Ex
Detector 1 Channel						
Detector 1 Extend (s)	0.0	0.0	0.0	0.0	0.0	0.0
Detector 1 Queue (s)	0.0	0.0	0.0	0.0	0.0	0.0
Detector 1 Delay (s)	0.0	0.0	0.0	0.0	0.0	0.0
Detector 2 Position(ft)		94	94			
Detector 2 Size(ft)		6	6			
Detector 2 Type		Cl+Ex	Cl+Ex			
Detector 2 Channel						
Detector 2 Extend (s)		0.0	0.0			
Turn Type	Prot	NA	NA	Prot	Prot	Prot
Protected Phases	1	6	2	2	8	8
Permitted Phases						

Lanes, Volumes, Timings  
2: McEwen /McEwen & Tower

11/18/2016

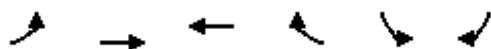

Lane Group	EBL	EBT	WBT	WBR	SBL	SBR
Detector Phase	1	6	2	2	8	8
Switch Phase						
Minimum Initial (s)	7.0	20.0	20.0	20.0	8.0	8.0
Minimum Split (s)	13.5	43.5	43.5	43.5	46.5	46.5
Total Split (s)	35.0	103.5	68.5	68.5	46.5	46.5
Total Split (%)	23.3%	69.0%	45.7%	45.7%	31.0%	31.0%
Maximum Green (s)	29.5	98.0	63.0	63.0	41.0	41.0
Yellow Time (s)	3.5	3.5	3.5	3.5	3.5	3.5
All-Red Time (s)	2.0	2.0	2.0	2.0	2.0	2.0
Lost Time Adjust (s)	0.0	0.0	0.0	0.0	0.0	0.0
Total Lost Time (s)	5.5	5.5	5.5	5.5	5.5	5.5
Lead/Lag	Lead		Lag	Lag		
Lead-Lag Optimize?						
Vehicle Extension (s)	3.0	3.0	3.0	3.0	3.0	3.0
Recall Mode	None	C-Min	C-Min	C-Min	None	None
Walk Time (s)		7.0	7.0	7.0	7.0	7.0
Flash Dont Walk (s)		18.0	18.0	18.0	34.0	34.0
Pedestrian Calls (#/hr)		3	3	3	3	3
Act Effct Green (s)	37.6	124.4	81.3	81.3	14.6	14.6
Actuated g/C Ratio	0.25	0.83	0.54	0.54	0.10	0.10
v/c Ratio	0.82	0.80	0.80	0.14	0.12	0.29
Control Delay	53.6	14.2	13.5	2.2	57.5	10.8
Queue Delay	0.0	0.0	0.0	0.0	0.0	0.0
Total Delay	53.6	14.2	13.5	2.2	57.5	10.8
LOS	D	B	B	A	E	B
Approach Delay		23.2	12.6		18.4	
Approach LOS		C	B		B	
90th %ile Green (s)	29.5	98.0	63.0	63.0	41.0	41.0
90th %ile Term Code	Max	Coord	Coord	Coord	Ped	Ped
70th %ile Green (s)	39.9	130.8	85.4	85.4	8.2	8.2
70th %ile Term Code	Gap	Coord	Coord	Coord	Gap	Gap
50th %ile Green (s)	39.3	131.0	86.2	86.2	8.0	8.0
50th %ile Term Code	Gap	Coord	Coord	Coord	Min	Min
30th %ile Green (s)	39.1	131.0	86.4	86.4	8.0	8.0
30th %ile Term Code	Gap	Coord	Coord	Coord	Min	Min
10th %ile Green (s)	40.2	131.0	85.3	85.3	8.0	8.0
10th %ile Term Code	Gap	Coord	Coord	Coord	Min	Min
Stops (vph)	506	1062	489	9	18	14
Fuel Used(gal)	16	32	17	1	0	1
CO Emissions (g/hr)	1095	2234	1163	65	28	48
NOx Emissions (g/hr)	213	435	226	13	5	9
VOC Emissions (g/hr)	254	518	270	15	6	11
Dilemma Vehicles (#)	0	0	0	0	0	0
Queue Length 50th (ft)	259	132	89	0	18	0
Queue Length 95th (ft)	#554	#1536	m#986	m13	40	33
Internal Link Dist (ft)		1131	858		431	
Turn Bay Length (ft)	285			115	445	
Base Capacity (vph)	774	2640	1725	788	435	756
Starvation Cap Reductn	0	0	0	0	0	0

Lanes, Volumes, Timings  
 2: McEwen /McEwen & Tower

11/18/2016

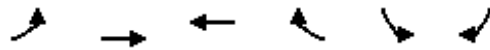

Lane Group	EBL	EBT	WBT	WBR	SBL	SBR
Spillback Cap Reductn	0	0	0	0	0	0
Storage Cap Reductn	0	0	0	0	0	0
Reduced v/c Ratio	0.82	0.80	0.80	0.14	0.04	0.13

Intersection Summary

Area Type: CBD  
 Cycle Length: 150  
 Actuated Cycle Length: 150  
 Offset: 86 (57%), Referenced to phase 2:WBT and 6:EBT, Start of Yellow  
 Natural Cycle: 105  
 Control Type: Actuated-Coordinated  
 Maximum v/c Ratio: 0.82  
 Intersection Signal Delay: 19.5  
 Intersection LOS: B  
 Intersection Capacity Utilization 83.0%  
 ICU Level of Service E  
 Analysis Period (min) 60  
 # 95th percentile volume exceeds capacity, queue may be longer.  
 Queue shown is maximum after two cycles.  
 m Volume for 95th percentile queue is metered by upstream signal.

Splits and Phases: 2: McEwen /McEwen & Tower



Lanes, Volumes, Timings  
3: Carothers/Carothers & McEwen

11/18/2016



Lane Group	EBL	EBT	EBR	WBL	WBT	WBR	NBL	NBT	NBR	SBL	SBT	SBR
Lane Configurations	↖↖	↗↗	↘	↖↖	↗↗	↘	↖↖	↗↗	↘	↖↖	↗↗	↘
Traffic Volume (vph)	1007	769	346	121	920	367	234	1071	91	175	302	241
Future Volume (vph)	1007	769	346	121	920	367	234	1071	91	175	302	241
Ideal Flow (vphpl)	1900	1900	1900	1900	1900	1900	1900	1900	1900	1900	1900	1900
Storage Length (ft)	205		205	218		97	300		300	280		310
Storage Lanes	2		1	2		1	2		1	2		1
Taper Length (ft)	25			25			25			25		
Lane Util. Factor	0.97	0.95	1.00	0.97	0.95	1.00	0.97	0.95	1.00	0.97	0.95	1.00
Frt			0.850			0.850			0.850			0.850
Flt Protected	0.950			0.950			0.950			0.950		
Satd. Flow (prot)	3433	3539	1583	3433	3539	1583	3433	3539	1583	3433	3539	1583
Flt Permitted	0.950			0.950			0.950			0.950		
Satd. Flow (perm)	3433	3539	1583	3433	3539	1583	3433	3539	1583	3433	3539	1583
Right Turn on Red			Yes			Yes			Yes			Yes
Satd. Flow (RTOR)			266			105			109			65
Link Speed (mph)		30			30			30				40
Link Distance (ft)		938			1960			1936				857
Travel Time (s)		21.3			44.5			44.0				14.6
Peak Hour Factor	1.00	1.00	1.00	1.00	1.00	1.00	1.00	1.00	1.00	1.00	1.00	1.00
Adj. Flow (vph)	1007	769	346	121	920	367	234	1071	91	175	302	241
Shared Lane Traffic (%)												
Lane Group Flow (vph)	1007	769	346	121	920	367	234	1071	91	175	302	241
Enter Blocked Intersection	No	No	No	No	No	No	No	No	No	No	No	No
Lane Alignment	Left	Left	Right	Left	Left	Right	Left	Left	Right	Left	Left	Right
Median Width(ft)		24			24			24				24
Link Offset(ft)		0			0			0				0
Crosswalk Width(ft)		16			16			16				16
Two way Left Turn Lane												
Headway Factor	1.00	1.00	1.00	1.00	1.00	1.00	1.00	1.00	1.00	1.00	1.00	1.00
Turning Speed (mph)	15		9	15		9	15		9	15		9
Number of Detectors	1	2	1	1	2	1	1	2	1	1	2	1
Detector Template	Left	Thru	Right	Left	Thru	Right	Left	Thru	Right	Left	Thru	Right
Leading Detector (ft)	20	100	20	20	100	20	20	100	20	20	100	20
Trailing Detector (ft)	0	0	0	0	0	0	0	0	0	0	0	0
Detector 1 Position(ft)	0	0	0	0	0	0	0	0	0	0	0	0
Detector 1 Size(ft)	20	6	20	20	6	20	20	6	20	20	6	20
Detector 1 Type	Cl+Ex	Cl+Ex	Cl+Ex	Cl+Ex	Cl+Ex	Cl+Ex	Cl+Ex	Cl+Ex	Cl+Ex	Cl+Ex	Cl+Ex	Cl+Ex
Detector 1 Channel												
Detector 1 Extend (s)	0.0	0.0	0.0	0.0	0.0	0.0	0.0	0.0	0.0	0.0	0.0	0.0
Detector 1 Queue (s)	0.0	0.0	0.0	0.0	0.0	0.0	0.0	0.0	0.0	0.0	0.0	0.0
Detector 1 Delay (s)	0.0	0.0	0.0	0.0	0.0	0.0	0.0	0.0	0.0	0.0	0.0	0.0
Detector 2 Position(ft)		94			94			94				94
Detector 2 Size(ft)		6			6			6				6
Detector 2 Type		Cl+Ex			Cl+Ex			Cl+Ex				Cl+Ex
Detector 2 Channel												
Detector 2 Extend (s)		0.0			0.0			0.0				0.0
Turn Type	Prot	NA	pm+ov	Prot	NA	pm+ov	Prot	NA	custom	Prot	NA	custom
Protected Phases	1	6	7	5	2	3	7	4	5	3	8	1
Permitted Phases			6			2			8			4

Lanes, Volumes, Timings  
3: Carothers/Carothers & McEwen

11/18/2016



Lane Group	EBL	EBT	EBR	WBL	WBT	WBR	NBL	NBT	NBR	SBL	SBT	SBR
Detector Phase	1	6	7	5	2	3	7	4	5	3	8	1
Switch Phase												
Minimum Initial (s)	6.0	13.0	6.0	4.0	13.0	6.0	6.0	13.0	4.0	6.0	13.0	6.0
Minimum Split (s)	13.0	52.0	12.5	10.0	52.0	13.0	12.5	52.0	10.0	13.0	52.0	13.0
Total Split (s)	31.0	69.0	14.0	15.0	53.0	14.0	14.0	52.0	15.0	14.0	52.0	31.0
Total Split (%)	20.7%	46.0%	9.3%	10.0%	35.3%	9.3%	9.3%	34.7%	10.0%	9.3%	34.7%	20.7%
Maximum Green (s)	25.0	63.0	8.0	9.5	47.0	8.0	8.0	46.0	9.5	8.0	46.0	25.0
Yellow Time (s)	4.0	4.0	4.0	3.5	4.0	4.0	4.0	4.0	3.5	4.0	4.0	4.0
All-Red Time (s)	2.0	2.0	2.0	2.0	2.0	2.0	2.0	2.0	2.0	2.0	2.0	2.0
Lost Time Adjust (s)	0.0	0.0	0.0	0.0	0.0	0.0	0.0	0.0	0.0	0.0	0.0	0.0
Total Lost Time (s)	6.0	6.0	6.0	5.5	6.0	6.0	6.0	6.0	5.5	6.0	6.0	6.0
Lead/Lag	Lead	Lag	Lead	Lead	Lag	Lead	Lead	Lag	Lead	Lead	Lag	Lead
Lead-Lag Optimize?												
Vehicle Extension (s)	3.0	3.0	3.0	3.0	3.0	3.0	3.0	3.0	3.0	3.0	3.0	3.0
Recall Mode	Max	C-Max	None	None	C-Max	None	None	None	None	None	None	Max
Walk Time (s)		7.0			7.0			7.0			7.0	
Flash Dont Walk (s)		39.0			39.0			37.0			37.0	
Pedestrian Calls (#/hr)		5			5			5			5	
Act Effct Green (s)	25.0	63.4	77.4	9.1	47.0	61.0	8.0	46.0	61.1	8.0	46.0	77.0
Actuated g/C Ratio	0.17	0.42	0.52	0.06	0.31	0.41	0.05	0.31	0.41	0.05	0.31	0.51
v/c Ratio	1.76	0.51	0.37	0.58	0.83	0.52	1.28	0.99	0.13	0.96	0.28	0.29
Control Delay	1410.9	32.4	8.4	65.4	41.8	21.5	596.5	95.2	3.3	165.9	40.3	15.8
Queue Delay	0.0	0.0	0.0	0.0	0.0	0.0	0.0	0.0	0.0	0.0	0.0	0.0
Total Delay	1410.9	32.4	8.4	65.4	41.8	21.5	596.5	95.2	3.3	165.9	40.3	15.8
LOS	F	C	A	E	D	C	F	F	A	F	D	B
Approach Delay		682.7			38.5			173.2			62.7	
Approach LOS		F			D			F			E	
90th %ile Green (s)	25.0	63.0	8.0	9.5	47.0	8.0	8.0	46.0	9.5	8.0	46.0	25.0
90th %ile Term Code	MaxR	Coord	Max	Max	Coord	Max	Max	Max	Max	Max	Hold	MaxR
70th %ile Green (s)	25.0	63.0	8.0	9.5	47.0	8.0	8.0	46.0	9.5	8.0	46.0	25.0
70th %ile Term Code	MaxR	Coord	Max	Max	Coord	Max	Max	Max	Max	Max	Hold	MaxR
50th %ile Green (s)	25.0	63.0	8.0	9.5	47.0	8.0	8.0	46.0	9.5	8.0	46.0	25.0
50th %ile Term Code	MaxR	Coord	Max	Max	Coord	Max	Max	Max	Max	Max	Hold	MaxR
30th %ile Green (s)	25.0	63.1	8.0	9.4	47.0	8.0	8.0	46.0	9.4	8.0	46.0	25.0
30th %ile Term Code	MaxR	Coord	Max	Gap	Coord	Max	Max	Max	Gap	Max	Hold	MaxR
10th %ile Green (s)	25.0	64.8	8.0	7.7	47.0	8.0	8.0	46.0	7.7	8.0	46.0	25.0
10th %ile Term Code	MaxR	Coord	Max	Gap	Coord	Max	Max	Max	Gap	Max	Hold	MaxR
Stops (vph)	972	477	67	116	701	299	209	981	6	156	224	97
Fuel Used(gal)	302	13	3	4	26	9	33	42	1	8	6	3
CO Emissions (g/hr)	21109	932	244	287	1800	620	2314	2959	103	591	450	219
NOx Emissions (g/hr)	4107	181	47	56	350	121	450	576	20	115	87	43
VOC Emissions (g/hr)	4892	216	57	66	417	144	536	686	24	137	104	51
Dilemma Vehicles (#)	0	0	0	0	0	0	0	0	0	0	8	0
Queue Length 50th (ft)	~753	238	62	61	314	155	~148	550	0	89	118	93
Queue Length 95th (ft)	m#1041	m372	m152	m75	m445	m199	#277	#845	35	#198	181	179
Internal Link Dist (ft)		858			1880			1856			777	
Turn Bay Length (ft)	205		205	218		97	300		300	280		310
Base Capacity (vph)	572	1495	945	217	1108	706	183	1085	713	183	1085	844
Starvation Cap Reductn	0	0	0	0	0	0	0	0	0	0	0	0

Lanes, Volumes, Timings  
 3: Carothers/Carothers & McEwen

11/18/2016



Lane Group	EBL	EBT	EBR	WBL	WBT	WBR	NBL	NBT	NBR	SBL	SBT	SBR
Spillback Cap Reductn	0	0	0	0	0	0	0	0	0	0	0	0
Storage Cap Reductn	0	0	0	0	0	0	0	0	0	0	0	0
Reduced v/c Ratio	1.76	0.51	0.37	0.56	0.83	0.52	1.28	0.99	0.13	0.96	0.28	0.29

Intersection Summary

Area Type: Other  
 Cycle Length: 150  
 Actuated Cycle Length: 150  
 Offset: 38 (25%), Referenced to phase 2:WBT and 6:EBT, Start of Yellow  
 Natural Cycle: 130  
 Control Type: Actuated-Coordinated  
 Maximum v/c Ratio: 1.76  
 Intersection Signal Delay: 317.1      Intersection LOS: F  
 Intersection Capacity Utilization 108.8%      ICU Level of Service G  
 Analysis Period (min) 60  
 ~ Volume exceeds capacity, queue is theoretically infinite.  
 Queue shown is maximum after two cycles.  
 # 95th percentile volume exceeds capacity, queue may be longer.  
 Queue shown is maximum after two cycles.  
 m Volume for 95th percentile queue is metered by upstream signal.

Splits and Phases: 3: Carothers/Carothers & McEwen



Lanes, Volumes, Timings  
4: Ovation/Resource Parkway & McEwen

11/18/2016



Lane Group	EBL	EBT	EBR	WBL	WBT	WBR	NBL	NBT	NBR	SBL	SBT	SBR
Lane Configurations												
Traffic Volume (vph)	276	268	381	160	1051	114	145	57	21	56	102	226
Future Volume (vph)	276	268	381	160	1051	114	145	57	21	56	102	226
Ideal Flow (vphpl)	1900	1900	1900	1900	1900	1900	1900	1900	1900	1900	1900	1900
Lane Util. Factor	1.00	0.95	1.00	1.00	0.95	0.95	0.97	1.00	1.00	1.00	1.00	1.00
Fr <sub>t</sub>			0.850		0.985				0.850		0.897	
Fl <sub>t</sub> Protected	0.950			0.950			0.950			0.950		
Satd. Flow (prot)	1770	3539	1583	1770	3486	0	3433	1863	1583	1770	1671	0
Fl <sub>t</sub> Permitted	0.136			0.587			0.248			0.720		
Satd. Flow (perm)	253	3539	1583	1093	3486	0	896	1863	1583	1341	1671	0
Right Turn on Red			Yes			Yes			Yes			Yes
Satd. Flow (RTOR)			381		17				73		135	
Link Speed (mph)		30			30			30			30	
Link Distance (ft)		1960			345			402			456	
Travel Time (s)		44.5			7.8			9.1			10.4	
Peak Hour Factor	1.00	1.00	1.00	1.00	1.00	1.00	1.00	1.00	1.00	1.00	1.00	1.00
Adj. Flow (vph)	276	268	381	160	1051	114	145	57	21	56	102	226
Shared Lane Traffic (%)												
Lane Group Flow (vph)	276	268	381	160	1165	0	145	57	21	56	328	0
Enter Blocked Intersection	No	No	No	No	No	No	No	No	No	No	No	No
Lane Alignment	Left	Left	Right	Left	Left	Right	Left	Left	Right	Left	Left	Right
Median Width(ft)		36			36			24			24	
Link Offset(ft)		0			0			0			0	
Crosswalk Width(ft)		16			16			16			16	
Two way Left Turn Lane												
Headway Factor	1.00	1.00	1.00	1.00	1.00	1.00	1.00	1.00	1.00	1.00	1.00	1.00
Turning Speed (mph)	15		9	15		9	15		9	15		9
Number of Detectors	1	2	1	1	2		1	2	1	1	2	
Detector Template	Left	Thru	Right	Left	Thru		Left	Thru	Right	Left	Thru	
Leading Detector (ft)	20	100	20	20	100		20	100	20	20	100	
Trailing Detector (ft)	0	0	0	0	0		0	0	0	0	0	
Detector 1 Position(ft)	0	0	0	0	0		0	0	0	0	0	
Detector 1 Size(ft)	20	6	20	20	6		20	6	20	20	6	
Detector 1 Type	Cl+Ex	Cl+Ex	Cl+Ex	Cl+Ex	Cl+Ex		Cl+Ex	Cl+Ex	Cl+Ex	Cl+Ex	Cl+Ex	
Detector 1 Channel												
Detector 1 Extend (s)	0.0	0.0	0.0	0.0	0.0		0.0	0.0	0.0	0.0	0.0	
Detector 1 Queue (s)	0.0	0.0	0.0	0.0	0.0		0.0	0.0	0.0	0.0	0.0	
Detector 1 Delay (s)	0.0	0.0	0.0	0.0	0.0		0.0	0.0	0.0	0.0	0.0	
Detector 2 Position(ft)		94			94			94			94	
Detector 2 Size(ft)		6			6			6			6	
Detector 2 Type		Cl+Ex			Cl+Ex			Cl+Ex			Cl+Ex	
Detector 2 Channel												
Detector 2 Extend (s)		0.0			0.0			0.0			0.0	
Turn Type	pm+pt	NA	pm+ov	pm+pt	NA		pm+pt	NA	pm+ov	pm+pt	NA	
Protected Phases	3	8	1	7	4		1	6	7	5	2	
Permitted Phases	8		8	4			6		6	2		
Detector Phase	3	8	1	7	4		1	6	7	5	2	
Switch Phase												
Minimum Initial (s)	4.0	4.0	4.0	4.0	4.0		4.0	4.0	4.0	4.0	4.0	

Lanes, Volumes, Timings  
4: Ovation/Resource Parkway & McEwen

11/18/2016

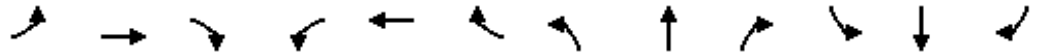

Lane Group	EBL	EBT	EBR	WBL	WBT	WBR	NBL	NBT	NBR	SBL	SBT	SBR
Minimum Split (s)	10.0	20.0	10.0	10.0	20.0		10.0	20.0	10.0	10.0	20.0	
Total Split (s)	13.0	35.0	10.0	10.0	32.0		10.0	20.0	10.0	10.0	20.0	
Total Split (%)	17.3%	46.7%	13.3%	13.3%	42.7%		13.3%	26.7%	13.3%	13.3%	26.7%	
Maximum Green (s)	9.0	31.0	6.0	6.0	28.0		6.0	16.0	6.0	6.0	16.0	
Yellow Time (s)	3.5	3.5	3.5	3.5	3.5		3.5	3.5	3.5	3.5	3.5	
All-Red Time (s)	0.5	0.5	0.5	0.5	0.5		0.5	0.5	0.5	0.5	0.5	
Lost Time Adjust (s)	0.0	0.0	0.0	0.0	0.0		0.0	0.0	0.0	0.0	0.0	
Total Lost Time (s)	4.0	4.0	4.0	4.0	4.0		4.0	4.0	4.0	4.0	4.0	
Lead/Lag	Lead	Lag	Lead	Lead	Lag		Lead	Lag	Lead	Lead	Lag	
Lead-Lag Optimize?												
Vehicle Extension (s)	3.0	3.0	3.0	3.0	3.0		3.0	3.0	3.0	3.0	3.0	
Recall Mode	None	C-Max	None	None	C-Max		None	Max	None	None	Max	
Walk Time (s)		5.0			5.0			5.0			5.0	
Flash Dont Walk (s)		11.0			11.0			11.0			11.0	
Pedestrian Calls (#/hr)		10			10			10			10	
Act Effct Green (s)	40.0	31.0	41.0	34.0	28.0		23.6	20.0	30.0	21.9	16.0	
Actuated g/C Ratio	0.53	0.41	0.55	0.45	0.37		0.31	0.27	0.40	0.29	0.21	
v/c Ratio	0.87	0.18	0.37	0.29	0.89		0.30	0.11	0.03	0.13	0.71	
Control Delay	48.4	12.8	8.3	10.5	33.1		18.6	24.1	0.1	17.6	26.2	
Queue Delay	0.0	0.0	0.0	0.0	0.0		0.0	0.0	0.0	0.0	0.0	
Total Delay	48.4	12.8	8.3	10.5	33.1		18.6	24.1	0.1	17.6	26.2	
LOS	D	B	A	B	C		B	C	A	B	C	
Approach Delay		21.5			30.3			18.3			24.9	
Approach LOS		C			C			B			C	
90th %ile Green (s)	9.0	31.0	6.0	6.0	28.0		6.0	16.0	6.0	6.0	16.0	
90th %ile Term Code	Max	Coord	Max	Max	Coord		Max	MaxR	Max	Max	MaxR	
70th %ile Green (s)	9.0	31.0	6.0	6.0	28.0		6.0	16.0	6.0	6.0	16.0	
70th %ile Term Code	Max	Coord	Max	Max	Coord		Max	MaxR	Max	Max	MaxR	
50th %ile Green (s)	9.0	31.0	6.0	6.0	28.0		6.0	16.0	6.0	6.0	16.0	
50th %ile Term Code	Max	Coord	Max	Max	Coord		Max	MaxR	Max	Max	MaxR	
30th %ile Green (s)	9.0	31.0	6.0	6.0	28.0		6.0	26.0	6.0	0.0	16.0	
30th %ile Term Code	Max	Coord	Max	Max	Coord		Max	MaxR	Max	Skip	MaxR	
10th %ile Green (s)	9.0	31.0	6.0	6.0	28.0		6.0	26.0	6.0	0.0	16.0	
10th %ile Term Code	Max	Coord	Max	Max	Coord		Max	MaxR	Max	Skip	MaxR	
Stops (vph)	200	197	226	86	994		97	46	0	39	178	
Fuel Used(gal)	8	6	8	1	16		2	1	0	1	4	
CO Emissions (g/hr)	562	411	539	87	1151		108	50	5	43	272	
NOx Emissions (g/hr)	109	80	105	17	224		21	10	1	8	53	
VOC Emissions (g/hr)	130	95	125	20	267		25	12	1	10	63	
Dilemma Vehicles (#)	0	0	0	0	0		0	0	0	0	0	
Queue Length 50th (ft)	116	57	169	34	257		23	22	0	17	81	
Queue Length 95th (ft)	m#290	m70	m243	71	#466		47	57	0	46	#245	
Internal Link Dist (ft)		1880			265			322			376	
Turn Bay Length (ft)												
Base Capacity (vph)	316	1462	1038	549	1312		484	496	676	427	462	
Starvation Cap Reductn	0	0	0	0	0		0	0	0	0	0	
Spillback Cap Reductn	0	0	0	0	0		0	0	0	0	0	
Storage Cap Reductn	0	0	0	0	0		0	0	0	0	0	
Reduced v/c Ratio	0.87	0.18	0.37	0.29	0.89		0.30	0.11	0.03	0.13	0.71	



Intersection Summary





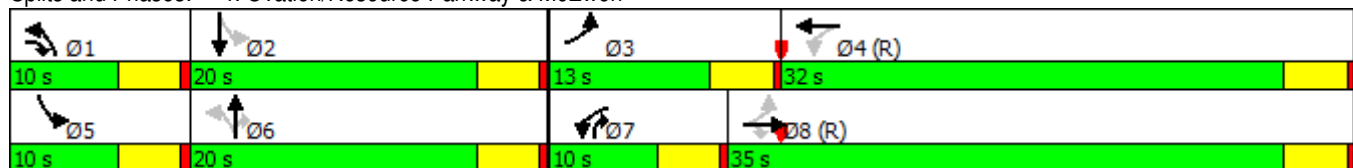





















Area Type:	Other
Cycle Length:	75
Actuated Cycle Length:	75
Offset:	40 (53%), Referenced to phase 4:WBTL and 8:EBTL, Start of Green
Natural Cycle:	75
Control Type:	Actuated-Coordinated
Maximum v/c Ratio:	0.89
Intersection Signal Delay:	25.8
Intersection LOS:	C
Intersection Capacity Utilization:	84.7%
ICU Level of Service:	E
Analysis Period (min):	60
#	95th percentile volume exceeds capacity, queue may be longer. Queue shown is maximum after two cycles.
m	Volume for 95th percentile queue is metered by upstream signal.

Splits and Phases: 4: Ovation/Resource Parkway & McEwen



Lanes, Volumes, Timings  
5: Carothers /Carothers & Tower/Pacific

11/18/2016

												
Lane Group	EBL	EBT	EBR	WBL	WBT	WBR	NBL	NBT	NBR	SBL	SBT	SBR
Lane Configurations	 							 			 	
Traffic Volume (vph)	109	0	53	132	1	48	195	2086	197	58	545	320
Future Volume (vph)	109	0	53	132	1	48	195	2086	197	58	545	320
Ideal Flow (vphpl)	1900	1900	1900	1900	1900	1900	1900	1900	1900	1900	1900	1900
Grade (%)		0%			0%			2%			0%	
Storage Length (ft)	84		78	106		77	177		100	85		144
Storage Lanes	2		1	1		1	1		1	1		1
Taper Length (ft)	25			25			25			25		
Lane Util. Factor	0.97	1.00	1.00	1.00	1.00	1.00	1.00	0.95	1.00	1.00	0.95	1.00
Fr <sub>t</sub>			0.850				0.850			0.850		0.850
Fl <sub>t</sub> Protected	0.950			0.950			0.950			0.950		
Satd. Flow (prot)	3433	1863	1583	1770	1863	1583	1752	3504	1567	1770	3539	1583
Fl <sub>t</sub> Permitted	0.950			0.950			0.392			0.051		
Satd. Flow (perm)	3433	1863	1583	1770	1863	1583	723	3504	1567	95	3539	1583
Right Turn on Red			Yes			Yes			Yes			Yes
Satd. Flow (RTOR)			252			152			105			314
Link Speed (mph)		30			30			40			30	
Link Distance (ft)		881			890			857			905	
Travel Time (s)		20.0			20.2			14.6			20.6	
Peak Hour Factor	1.00	1.00	1.00	1.00	1.00	1.00	1.00	1.00	1.00	1.00	1.00	1.00
Adj. Flow (vph)	109	0	53	132	1	48	195	2086	197	58	545	320
Shared Lane Traffic (%)												
Lane Group Flow (vph)	109	0	53	132	1	48	195	2086	197	58	545	320
Enter Blocked Intersection	No	No	No	No	No	No	No	No	No	No	No	No
Lane Alignment	Left	Left	Right	Left	Left	Right	Left	Left	Right	Left	Left	Right
Median Width(ft)		24			24			24			24	
Link Offset(ft)		0			0			0			0	
Crosswalk Width(ft)		16			16			16			16	
Two way Left Turn Lane												
Headway Factor	1.00	1.00	1.00	1.00	1.00	1.00	1.01	1.01	1.01	1.00	1.00	1.00
Turning Speed (mph)	15		9	15		9	15		9	15		9
Number of Detectors	1	2	1	1	2	1	1	2	1	1	2	1
Detector Template	Left	Thru	Right	Left	Thru	Right	Left	Thru	Right	Left	Thru	Right
Leading Detector (ft)	20	100	20	20	100	20	20	100	20	20	100	20
Trailing Detector (ft)	0	0	0	0	0	0	0	0	0	0	0	0
Detector 1 Position(ft)	0	0	0	0	0	0	0	0	0	0	0	0
Detector 1 Size(ft)	20	6	20	20	6	20	20	6	20	20	6	20
Detector 1 Type	Cl+Ex	Cl+Ex	Cl+Ex	Cl+Ex	Cl+Ex	Cl+Ex	Cl+Ex	Cl+Ex	Cl+Ex	Cl+Ex	Cl+Ex	Cl+Ex
Detector 1 Channel												
Detector 1 Extend (s)	0.0	0.0	0.0	0.0	0.0	0.0	0.0	0.0	0.0	0.0	0.0	0.0
Detector 1 Queue (s)	0.0	0.0	0.0	0.0	0.0	0.0	0.0	0.0	0.0	0.0	0.0	0.0
Detector 1 Delay (s)	0.0	0.0	0.0	0.0	0.0	0.0	0.0	0.0	0.0	0.0	0.0	0.0
Detector 2 Position(ft)		94			94			94			94	
Detector 2 Size(ft)		6			6			6			6	
Detector 2 Type		Cl+Ex			Cl+Ex			Cl+Ex			Cl+Ex	
Detector 2 Channel												
Detector 2 Extend (s)		0.0			0.0			0.0			0.0	
Turn Type	Prot		Perm	Prot	NA	Perm	pm+pt	NA	Perm	pm+pt	NA	Perm
Protected Phases	3	8		7	4		1	6		5	2	

Lanes, Volumes, Timings  
5: Carothers /Carothers & Tower/Pacific

11/18/2016



Lane Group	EBL	EBT	EBR	WBL	WBT	WBR	NBL	NBT	NBR	SBL	SBT	SBR
Permitted Phases			8			4	6		6	2		2
Detector Phase	3	8	8	7	4	4	1	6	6	5	2	2
Switch Phase												
Minimum Initial (s)	6.0	8.0	8.0	6.0	8.0	8.0	6.0	20.0	20.0	6.0	20.0	20.0
Minimum Split (s)	12.5	48.5	48.5	12.5	48.5	48.5	12.0	42.0	42.0	12.0	42.0	42.0
Total Split (s)	12.5	48.5	48.5	14.0	50.0	50.0	18.0	65.5	65.5	12.0	59.5	59.5
Total Split (%)	8.9%	34.6%	34.6%	10.0%	35.7%	35.7%	12.9%	46.8%	46.8%	8.6%	42.5%	42.5%
Maximum Green (s)	7.0	43.0	43.0	8.5	44.5	44.5	12.5	59.5	59.5	6.5	53.5	53.5
Yellow Time (s)	3.5	3.5	3.5	3.5	3.5	3.5	3.5	4.0	4.0	3.5	4.0	4.0
All-Red Time (s)	2.0	2.0	2.0	2.0	2.0	2.0	2.0	2.0	2.0	2.0	2.0	2.0
Lost Time Adjust (s)	0.0	0.0	0.0	0.0	0.0	0.0	0.0	0.0	0.0	0.0	0.0	0.0
Total Lost Time (s)	5.5	5.5	5.5	5.5	5.5	5.5	5.5	6.0	6.0	5.5	6.0	6.0
Lead/Lag	Lead	Lag	Lag	Lead	Lag	Lag	Lead	Lag	Lag	Lead	Lag	Lag
Lead-Lag Optimize?												
Vehicle Extension (s)	3.0	3.0	3.0	3.0	3.0	3.0	3.0	3.0	3.0	3.0	3.0	3.0
Recall Mode	None	None	None	None	None	None	None	C-Min	C-Min	None	C-Min	C-Min
Walk Time (s)		7.0	7.0		7.0	7.0		7.0	7.0		7.0	7.0
Flash Dont Walk (s)		36.0	36.0		36.0	36.0		29.0	29.0		29.0	29.0
Pedestrian Calls (#/hr)		10	10		10	10		10	10		10	10
Act Effct Green (s)	7.3		22.0	8.5	23.2	23.2	94.6	85.6	85.6	86.6	79.7	79.7
Actuated g/C Ratio	0.05		0.16	0.06	0.17	0.17	0.68	0.61	0.61	0.62	0.57	0.57
v/c Ratio	0.61		0.11	1.23	0.00	0.12	0.35	0.97	0.20	0.43	0.27	0.31
Control Delay	80.9		0.5	547.7	35.0	0.6	13.8	49.3	9.8	48.4	21.9	7.5
Queue Delay	0.0		0.0	0.0	0.0	0.0	0.0	0.0	0.0	0.0	0.0	0.0
Total Delay	80.9		0.5	547.7	35.0	0.6	13.8	49.3	9.8	48.4	21.9	7.5
LOS	F		A	F	C	A	B	D	A	D	C	A
Approach Delay					399.8			43.4			18.6	
Approach LOS					F			D			B	
90th %ile Green (s)	7.0	43.0	43.0	8.5	44.5	44.5	12.5	59.5	59.5	6.5	53.5	53.5
90th %ile Term Code	Max	Ped	Ped	Max	Hold	Hold	Max	Coord	Coord	Max	Coord	Coord
70th %ile Green (s)	7.0	43.0	43.0	8.5	44.5	44.5	12.5	59.5	59.5	6.5	53.5	53.5
70th %ile Term Code	Max	Ped	Ped	Max	Hold	Hold	Max	Coord	Coord	Max	Coord	Coord
50th %ile Green (s)	7.0	8.0	8.0	8.5	9.5	9.5	9.6	94.4	94.4	6.6	91.4	91.4
50th %ile Term Code	Max	Min	Min	Max	Hold	Hold	Gap	Coord	Coord	Gap	Coord	Coord
30th %ile Green (s)	7.0	8.0	8.0	8.5	9.5	9.5	8.7	94.8	94.8	6.2	92.3	92.3
30th %ile Term Code	Max	Min	Min	Max	Hold	Hold	Gap	Coord	Coord	Gap	Coord	Coord
10th %ile Green (s)	8.5	0.0	0.0	8.5	0.0	0.0	6.7	120.0	120.0	0.0	107.8	107.8
10th %ile Term Code	Hold	Skip	Skip	Max	Skip	Skip	Gap	Coord	Coord	Skip	Coord	Coord
Stops (vph)	105		0	115	2	0	78	1263	49	38	200	41
Fuel Used(gal)	3		0	16	0	0	2	45	2	1	7	3
CO Emissions (g/hr)	218		26	1137	2	24	171	3180	141	83	516	208
NOx Emissions (g/hr)	42		5	221	0	5	33	619	27	16	100	40
VOC Emissions (g/hr)	51		6	264	0	5	40	737	33	19	120	48
Dilemma Vehicles (#)	0		0	0	0	0	0	63	0	0	0	0
Queue Length 50th (ft)	51		0	~148	1	0	41	746	27	11	74	2
Queue Length 95th (ft)	#107		0	#329	6	0	163	#1713	130	#105	192	142
Internal Link Dist (ft)		801			810			777			825	
Turn Bay Length (ft)	84		78	106		77	177		100	85		144
Base Capacity (vph)	178		660	107	592	606	586	2143	999	136	2014	1036

Lanes, Volumes, Timings  
 5: Carothers /Carothers & Tower/Pacific

11/18/2016

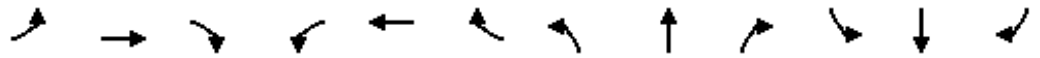

Lane Group	EBL	EBT	EBR	WBL	WBT	WBR	NBL	NBT	NBR	SBL	SBT	SBR
Starvation Cap Reductn	0		0	0	0	0	0	0	0	0	0	0
Spillback Cap Reductn	0		0	0	0	0	0	0	0	0	0	0
Storage Cap Reductn	0		0	0	0	0	0	0	0	0	0	0
Reduced v/c Ratio	0.61		0.08	1.23	0.00	0.08	0.33	0.97	0.20	0.43	0.27	0.31

Intersection Summary

Area Type: Other  
 Cycle Length: 140  
 Actuated Cycle Length: 140  
 Offset: 120 (86%), Referenced to phase 2:SBTL and 6:NBTL, Start of Yellow  
 Natural Cycle: 115  
 Control Type: Actuated-Coordinated  
 Maximum v/c Ratio: 1.23  
 Intersection Signal Delay: 55.0  
 Intersection LOS: D  
 Intersection Capacity Utilization 90.8%  
 ICU Level of Service E  
 Analysis Period (min) 60  
 ~ Volume exceeds capacity, queue is theoretically infinite.  
 Queue shown is maximum after two cycles.  
 # 95th percentile volume exceeds capacity, queue may be longer.  
 Queue shown is maximum after two cycles.

Splits and Phases: 5: Carothers /Carothers & Tower/Pacific



Lanes, Volumes, Timings  
6: Carothers/Carothers Parkway & Apartments/Resource

11/18/2016

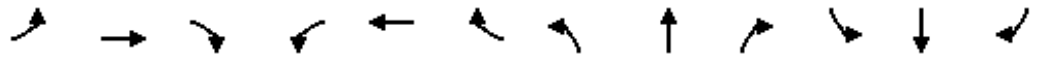

Lane Group	EBL	EBT	EBR	WBL	WBT	WBR	NBL	NBT	NBR	SBL	SBT	SBR
Lane Configurations												
Traffic Volume (vph)	35	0	52	9	0	127	123	2184	1	147	877	184
Future Volume (vph)	35	0	52	9	0	127	123	2184	1	147	877	184
Ideal Flow (vphpl)	1900	1900	1900	1900	1900	1900	1900	1900	1900	1900	1900	1900
Grade (%)		0%			0%			2%			0%	
Storage Length (ft)	0		0	0		0	210		128	480		93
Storage Lanes	1		0	1		1	1		0	1		1
Taper Length (ft)	25			25			25			25		
Lane Util. Factor	1.00	1.00	1.00	1.00	1.00	1.00	1.00	0.95	0.95	1.00	0.95	1.00
Fr <sub>t</sub>		0.850				0.850						0.850
Fl <sub>t</sub> Protected	0.950			0.950			0.950			0.950		
Satd. Flow (prot)	1770	1583	0	1770	1863	1583	1752	3504	0	1770	3539	1583
Fl <sub>t</sub> Permitted	0.592			0.723			0.286			0.047		
Satd. Flow (perm)	1103	1583	0	1347	1863	1583	527	3504	0	88	3539	1583
Right Turn on Red			Yes			Yes			Yes			Yes
Satd. Flow (RTOR)		242				92						97
Link Speed (mph)		30			30			40				40
Link Distance (ft)		762			773			905				2004
Travel Time (s)		17.3			17.6			15.4				34.2
Peak Hour Factor	1.00	1.00	1.00	1.00	1.00	1.00	1.00	1.00	1.00	1.00	1.00	1.00
Adj. Flow (vph)	35	0	52	9	0	127	123	2184	1	147	877	184
Shared Lane Traffic (%)												
Lane Group Flow (vph)	35	52	0	9	0	127	123	2185	0	147	877	184
Enter Blocked Intersection	No	No	No	No	No	No	No	No	No	No	No	No
Lane Alignment	Left	Left	Right	Left	Left	Right	Left	Left	Right	Left	Left	Right
Median Width(ft)		12			12			12				12
Link Offset(ft)		0			0			0				0
Crosswalk Width(ft)		16			16			16				16
Two way Left Turn Lane												
Headway Factor	1.00	1.00	1.00	1.00	1.00	1.00	1.01	1.01	1.01	1.00	1.00	1.00
Turning Speed (mph)	15		9	15		9	15		9	15		9
Number of Detectors	1	2		1	2	1	1	2		1	2	1
Detector Template	Left	Thru		Left	Thru	Right	Left	Thru		Left	Thru	Right
Leading Detector (ft)	20	100		20	100	20	20	100		20	100	20
Trailing Detector (ft)	0	0		0	0	0	0	0		0	0	0
Detector 1 Position(ft)	0	0		0	0	0	0	0		0	0	0
Detector 1 Size(ft)	20	6		20	6	20	20	6		20	6	20
Detector 1 Type	Cl+Ex	Cl+Ex		Cl+Ex	Cl+Ex	Cl+Ex	Cl+Ex	Cl+Ex		Cl+Ex	Cl+Ex	Cl+Ex
Detector 1 Channel												
Detector 1 Extend (s)	0.0	0.0		0.0	0.0	0.0	0.0	0.0		0.0	0.0	0.0
Detector 1 Queue (s)	0.0	0.0		0.0	0.0	0.0	0.0	0.0		0.0	0.0	0.0
Detector 1 Delay (s)	0.0	0.0		0.0	0.0	0.0	0.0	0.0		0.0	0.0	0.0
Detector 2 Position(ft)		94			94			94				94
Detector 2 Size(ft)		6			6			6				6
Detector 2 Type		Cl+Ex			Cl+Ex			Cl+Ex				Cl+Ex
Detector 2 Channel												
Detector 2 Extend (s)		0.0			0.0			0.0				0.0
Turn Type	pm+pt	NA		pm+pt		pm+ov	pm+pt	NA		pm+pt	NA	pm+ov
Protected Phases	3	8		7	4	5	1	6		5	2	3

Lanes, Volumes, Timings  
6: Carothers/Carothers Parkway & Apartments/Resource

11/18/2016



Lane Group	EBL	EBT	EBR	WBL	WBT	WBR	NBL	NBT	NBR	SBL	SBT	SBR
Permitted Phases	8			4		4	6			2		2
Detector Phase	3	8		7	4	5	1	6		5	2	3
Switch Phase												
Minimum Initial (s)	5.0	6.0		5.0	6.0	5.0	5.0	15.0		5.0	15.0	5.0
Minimum Split (s)	12.0	48.5		12.0	48.5	11.5	11.5	48.0		11.5	48.0	12.0
Total Split (s)	12.0	48.5		12.0	48.5	11.5	15.6	68.0		11.5	63.9	12.0
Total Split (%)	8.6%	34.6%		8.6%	34.6%	8.2%	11.1%	48.6%		8.2%	45.6%	8.6%
Maximum Green (s)	6.5	43.0		6.5	43.0	6.0	10.1	62.0		6.0	57.9	6.5
Yellow Time (s)	3.5	3.5		3.5	3.5	3.5	3.5	4.0		3.5	4.0	3.5
All-Red Time (s)	2.0	2.0		2.0	2.0	2.0	2.0	2.0		2.0	2.0	2.0
Lost Time Adjust (s)	0.0	0.0		0.0	0.0	0.0	0.0	0.0		0.0	0.0	0.0
Total Lost Time (s)	5.5	5.5		5.5	5.5	5.5	5.5	6.0		5.5	6.0	5.5
Lead/Lag	Lead	Lag		Lead	Lag	Lead	Lead	Lag		Lead	Lag	Lead
Lead-Lag Optimize?												
Vehicle Extension (s)	3.0	3.0		3.0	3.0	3.0	3.0	3.0		3.0	3.0	3.0
Recall Mode	None	None		None	None	None	None	C-Max		None	C-Max	None
Walk Time (s)		7.0			7.0			7.0			7.0	
Flash Dont Walk (s)		36.0			36.0			35.0			35.0	
Pedestrian Calls (#/hr)		10			10			10			10	
Act Effct Green (s)	24.7	23.4		23.2		30.7	94.3	85.9		99.4	89.3	101.7
Actuated g/C Ratio	0.18	0.17		0.17		0.22	0.67	0.61		0.71	0.64	0.73
v/c Ratio	0.16	0.11		0.04		0.30	0.29	1.02		0.74	0.39	0.16
Control Delay	39.8	0.5		33.3		13.2	3.1	58.0		57.7	18.3	6.7
Queue Delay	0.0	0.0		0.0		0.0	0.0	0.0		0.0	0.0	0.0
Total Delay	39.8	0.5		33.3		13.2	3.1	58.0		57.7	18.3	6.7
LOS	D	A		C		B	A	E		E	B	A
Approach Delay		16.3						55.0			21.3	
Approach LOS		B						E			C	
90th %ile Green (s)	6.5	43.0		6.5	43.0	6.0	10.1	62.0		6.0	57.9	6.5
90th %ile Term Code	Max	Ped		Max	Ped	Max	Max	Coord		Max	Coord	Max
70th %ile Green (s)	6.5	55.0		0.0	43.0	6.0	10.1	62.0		6.0	57.9	6.5
70th %ile Term Code	Max	Hold		Skip	Ped	Max	Max	Coord		Max	Coord	Max
50th %ile Green (s)	6.5	6.5		0.0	0.0	12.5	6.8	104.0		12.5	109.7	6.5
50th %ile Term Code	Max	Hold		Skip	Skip	Gap	Gap	Coord		Gap	Coord	Max
30th %ile Green (s)	6.5	6.5		0.0	0.0	13.6	6.4	102.9		13.6	110.1	6.5
30th %ile Term Code	Max	Hold		Skip	Skip	Gap	Gap	Coord		Gap	Coord	Max
10th %ile Green (s)	6.0	6.0		0.0	0.0	18.5	6.0	98.5		18.5	111.0	6.0
10th %ile Term Code	Hold	Hold		Skip	Skip	Gap	Gap	Coord		Gap	Coord	Hold
Stops (vph)	26	0		8		29	10	558		52	439	36
Fuel Used(gal)	1	0		0		1	1	45		4	20	3
CO Emissions (g/hr)	44	22		11		88	65	3123		296	1363	217
NOx Emissions (g/hr)	9	4		2		17	13	608		58	265	42
VOC Emissions (g/hr)	10	5		3		21	15	724		69	316	50
Dilemma Vehicles (#)	0	0		0		0	0	27		0	31	0
Queue Length 50th (ft)	32	0		8		30	6	66		62	103	8
Queue Length 95th (ft)	48	0		19		78	m9	m#1478		#330	458	104
Internal Link Dist (ft)		682			693			825			1924	
Turn Bay Length (ft)							210			480		93
Base Capacity (vph)	226	676		247		419	451	2149		198	2257	1177

Lanes, Volumes, Timings  
 6: Carothers/Carothers Parkway & Apartments/Resource

11/18/2016



Lane Group	EBL	EBT	EBR	WBL	WBT	WBR	NBL	NBT	NBR	SBL	SBT	SBR
Starvation Cap Reductn	0	0		0		0	0	0		0	0	0
Spillback Cap Reductn	0	0		0		0	0	0		0	0	0
Storage Cap Reductn	0	0		0		0	0	0		0	0	0
Reduced v/c Ratio	0.15	0.08		0.04		0.30	0.27	1.02		0.74	0.39	0.16

Intersection Summary

Area Type: Other  
 Cycle Length: 140  
 Actuated Cycle Length: 140  
 Offset: 136 (97%), Referenced to phase 2:SBTL and 6:NBTL, Start of Yellow  
 Natural Cycle: 120  
 Control Type: Actuated-Coordinated  
 Maximum v/c Ratio: 1.02  
 Intersection Signal Delay: 41.8 Intersection LOS: D  
 Intersection Capacity Utilization 91.3% ICU Level of Service F  
 Analysis Period (min) 60  
 # 95th percentile volume exceeds capacity, queue may be longer.  
 Queue shown is maximum after two cycles.  
 m Volume for 95th percentile queue is metered by upstream signal.

Splits and Phases: 6: Carothers/Carothers Parkway & Apartments/Resource

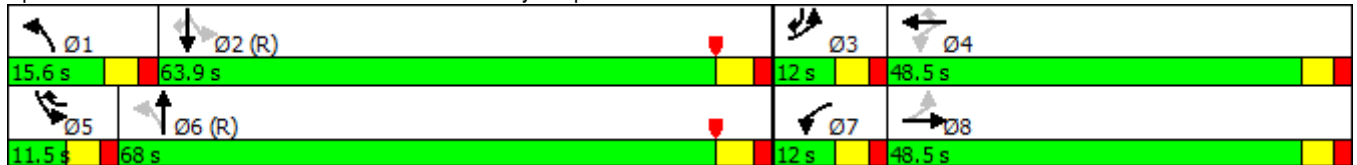

Lanes, Volumes, Timings

1: I65 NB off Ramp /I65 SB off ramp & McEwen/McEwen

11/18/2016

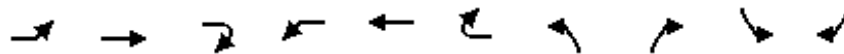

Lane Group	EBL	EBT	EBR2	WBL	WBT	WBR2	NBL	NBR2	SBL	SBR2
Lane Configurations										
Traffic Volume (vph)	572	930	366	559	1252	1214	285	187	660	671
Future Volume (vph)	572	930	366	559	1252	1214	285	187	660	671
Ideal Flow (vphpl)	1900	1900	1900	1900	1900	1900	1900	1900	1900	1900
Storage Length (ft)	370			495			0		0	
Storage Lanes	2			1			2		2	
Taper Length (ft)	25			25			25		25	
Lane Util. Factor	0.97	0.95	1.00	1.00	0.95	1.00	0.97	1.00	0.97	0.88
Frt			0.850				0.850		0.850	0.850
Flt Protected	0.950			0.950			0.950		0.950	
Satd. Flow (prot)	3433	3539	1583	1770	3539	1583	3433	1583	3433	2787
Flt Permitted	0.950			0.950			0.950		0.950	
Satd. Flow (perm)	3433	3539	1583	1770	3539	1583	3433	1583	3433	2787
Right Turn on Red			Yes			Yes		Yes		Yes
Satd. Flow (RTOR)			198			542		187		131
Link Speed (mph)		30			30					
Link Distance (ft)		826			1211					
Travel Time (s)		18.8			27.5					
Peak Hour Factor	1.00	1.00	1.00	1.00	1.00	1.00	1.00	1.00	1.00	1.00
Adj. Flow (vph)	572	930	366	559	1252	1214	285	187	660	671
Shared Lane Traffic (%)										
Lane Group Flow (vph)	572	930	366	559	1252	1214	285	187	660	671
Enter Blocked Intersection	No	No	No	No	No	No	No	No	No	No
Lane Alignment	Left	Left	Right	Left	Left	Right	Left	Right	Left	Right
Median Width(ft)		24			24					
Link Offset(ft)		0			0					
Crosswalk Width(ft)		16			16					
Two way Left Turn Lane										
Headway Factor	1.00	1.00	1.00	1.00	1.00	1.00	1.00	1.00	1.00	1.00
Turning Speed (mph)	15		9	15		9	15	9	15	9
Number of Detectors	1	2	1	1	2	1	1	1	1	1
Detector Template	Left	Thru	Right	Left	Thru	Right	Left	Right	Left	Right
Leading Detector (ft)	20	100	20	20	100	20	20	20	20	20
Trailing Detector (ft)	0	0	0	0	0	0	0	0	0	0
Detector 1 Position(ft)	0	0	0	0	0	0	0	0	0	0
Detector 1 Size(ft)	20	6	20	20	6	20	20	20	20	20
Detector 1 Type	Cl+Ex	Cl+Ex	Cl+Ex	Cl+Ex	Cl+Ex	Cl+Ex	Cl+Ex	Cl+Ex	Cl+Ex	Cl+Ex
Detector 1 Channel										
Detector 1 Extend (s)	0.0	0.0	0.0	0.0	0.0	0.0	0.0	0.0	0.0	0.0
Detector 1 Queue (s)	0.0	0.0	0.0	0.0	0.0	0.0	0.0	0.0	0.0	0.0
Detector 1 Delay (s)	0.0	0.0	0.0	0.0	0.0	0.0	0.0	0.0	0.0	0.0
Detector 2 Position(ft)		94			94					
Detector 2 Size(ft)		6			6					
Detector 2 Type		Cl+Ex			Cl+Ex					
Detector 2 Channel										
Detector 2 Extend (s)		0.0			0.0					
Turn Type	Prot	NA	Free	Prot	NA	Perm	Perm	Free	Perm	Prot
Protected Phases	1	6		5	2					1
Permitted Phases			Free			2	3	Free	7	



Lanes, Volumes, Timings

1: I65 NB off Ramp /I65 SB off ramp & McEwen/McEwen

11/18/2016

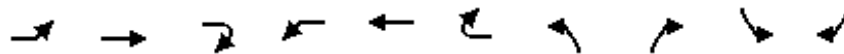

Lane Group	EBL	EBT	EBR2	WBL	WBT	WBR2	NBL	NBR2	SBL	SBR2
Detector Phase	1	6		5	2	2	3		7	1
Switch Phase										
Minimum Initial (s)	8.0	12.0		8.0	12.0	12.0	12.0		12.0	8.0
Minimum Split (s)	15.0	27.0		25.0	27.0	27.0	27.0		27.0	15.0
Total Split (s)	34.0	57.0		60.0	83.0	83.0	33.0		33.0	34.0
Total Split (%)	22.7%	38.0%		40.0%	55.3%	55.3%	22.0%		22.0%	22.7%
Maximum Green (s)	27.0	50.0		53.0	76.0	76.0	26.0		26.0	27.0
Yellow Time (s)	4.0	4.0		4.0	4.0	4.0	4.0		4.0	4.0
All-Red Time (s)	3.0	3.0		3.0	3.0	3.0	3.0		3.0	3.0
Lost Time Adjust (s)	0.0	0.0		0.0	0.0	0.0	0.0		0.0	0.0
Total Lost Time (s)	7.0	7.0		7.0	7.0	7.0	7.0		7.0	7.0
Lead/Lag	Lead	Lag		Lead	Lag	Lag				Lead
Lead-Lag Optimize?										
Vehicle Extension (s)	3.0	3.0		3.0	3.0	3.0	3.0		3.0	3.0
Recall Mode	None	C-Min		None	C-Min	C-Min	None		None	None
Walk Time (s)		7.0			7.0	7.0	7.0		7.0	
Flash Dont Walk (s)		13.0			13.0	13.0	13.0		13.0	
Pedestrian Calls (#/hr)		5			5	5	5		5	
Act Effct Green (s)	27.0	52.7	150.0	50.3	76.0	76.0	26.0	150.0	26.0	27.0
Actuated g/C Ratio	0.18	0.35	1.00	0.34	0.51	0.51	0.17	1.00	0.17	0.18
v/c Ratio	0.93	0.75	0.23	0.94	0.70	1.14	0.48	0.12	1.11	1.10
Control Delay	87.9	45.8	0.3	42.2	29.7	274.1	59.0	0.1	279.0	255.5
Queue Delay	0.0	0.0	0.0	0.0	0.0	0.0	0.0	0.0	0.0	0.0
Total Delay	87.9	45.8	0.3	42.2	29.7	274.1	59.0	0.1	279.0	255.5
LOS	F	D	A	D	C	F	E	A	F	F
Approach Delay		49.7			130.1					
Approach LOS		D			F					
90th %ile Green (s)	27.0	50.0		53.0	76.0	76.0	26.0		26.0	27.0
90th %ile Term Code	Max	Coord		Max	Coord	Coord	Hold		Max	Max
70th %ile Green (s)	27.0	50.0		53.0	76.0	76.0	26.0		26.0	27.0
70th %ile Term Code	Max	Coord		Max	Coord	Coord	Hold		Max	Max
50th %ile Green (s)	27.0	50.0		53.0	76.0	76.0	26.0		26.0	27.0
50th %ile Term Code	Max	Coord		Max	Coord	Coord	Hold		Max	Max
30th %ile Green (s)	27.0	53.4		49.6	76.0	76.0	26.0		26.0	27.0
30th %ile Term Code	Max	Coord		Gap	Coord	Coord	Hold		Max	Max
10th %ile Green (s)	27.0	60.2		42.8	76.0	76.0	26.0		26.0	27.0
10th %ile Term Code	Max	Coord		Gap	Coord	Coord	Hold		Max	Max
Stops (vph)	530	805	0	485	1091	933	252	0	602	503
Fuel Used(gal)	17	19	2	13	25	84	6	1	45	42
CO Emissions (g/hr)	1177	1335	167	892	1777	5897	454	77	3134	2919
NOx Emissions (g/hr)	229	260	32	174	346	1147	88	15	610	568
VOC Emissions (g/hr)	273	309	39	207	412	1367	105	18	726	676
Dilemma Vehicles (#)	0	0	0	0	0	0	0	0	0	0
Queue Length 50th (ft)	288	442	0	461	578	~1136	131	0	~378	~359
Queue Length 95th (ft)	#483	541	0	m376	m496	m898	202	0	#595	#603
Internal Link Dist (ft)		746			1131					
Turn Bay Length (ft)	370			495						
Base Capacity (vph)	617	1243	1583	625	1793	1069	595	1583	595	609
Starvation Cap Reductn	0	0	0	0	0	0	0	0	0	0

Lanes, Volumes, Timings

1: I65 NB off Ramp /I65 SB off ramp & McEwen/McEwen

11/18/2016

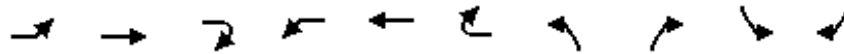

Lane Group	EBL	EBT	EBR2	WBL	WBT	WBR2	NBL	NBR2	SBL	SBR2
Spillback Cap Reductn	0	0	0	0	19	0	0	0	0	0
Storage Cap Reductn	0	0	0	0	0	0	0	0	0	0
Reduced v/c Ratio	0.93	0.75	0.23	0.89	0.71	1.14	0.48	0.12	1.11	1.10

Intersection Summary

Area Type: Other

Cycle Length: 150

Actuated Cycle Length: 150

Offset: 138 (92%), Referenced to phase 2:WBT and 6:EBT, Start of Yellow

Natural Cycle: 100

Control Type: Actuated-Coordinated

Maximum v/c Ratio: 1.14

Intersection Signal Delay: 128.3

Intersection LOS: F

Intersection Capacity Utilization Err%

ICU Level of Service H

Analysis Period (min) 60

~ Volume exceeds capacity, queue is theoretically infinite.

Queue shown is maximum after two cycles.

# 95th percentile volume exceeds capacity, queue may be longer.

Queue shown is maximum after two cycles.

m Volume for 95th percentile queue is metered by upstream signal.

Splits and Phases: 1: I65 NB off Ramp /I65 SB off ramp & McEwen/McEwen

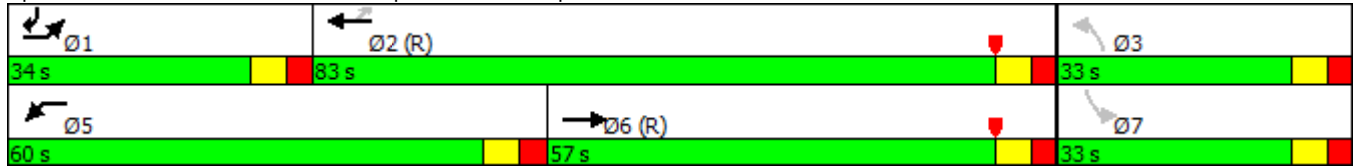

Lanes, Volumes, Timings  
2: McEwen /McEwen & Tower

11/18/2016

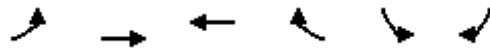

Lane Group	EBL	EBT	WBT	WBR	SBL	SBR
Lane Configurations	↖↖	↗↗	↖↖	↗	↘	↘↘
Traffic Volume (vph)	160	1611	2386	22	170	627
Future Volume (vph)	160	1611	2386	22	170	627
Ideal Flow (vphpl)	1900	1900	1900	1900	1900	1900
Storage Length (ft)	285			115	445	0
Storage Lanes	2			1	1	2
Taper Length (ft)	25				25	
Lane Util. Factor	0.97	0.95	0.95	1.00	1.00	0.88
Fr <sub>t</sub>				0.850		0.850
Fl <sub>t</sub> Protected	0.950				0.950	
Satd. Flow (prot)	3090	3185	3185	1425	1593	2508
Fl <sub>t</sub> Permitted	0.950				0.950	
Satd. Flow (perm)	3090	3185	3185	1425	1593	2508
Right Turn on Red				Yes		Yes
Satd. Flow (RTOR)				5		171
Link Speed (mph)		30	30		30	
Link Distance (ft)		1211	938		511	
Travel Time (s)		27.5	21.3		11.6	
Peak Hour Factor	1.00	1.00	1.00	1.00	1.00	1.00
Adj. Flow (vph)	160	1611	2386	22	170	627
Shared Lane Traffic (%)						
Lane Group Flow (vph)	160	1611	2386	22	170	627
Enter Blocked Intersection	No	No	No	No	No	No
Lane Alignment	Left	Left	Left	Right	Left	Right
Median Width(ft)		24	24		12	
Link Offset(ft)		0	0		0	
Crosswalk Width(ft)		16	16		16	
Two way Left Turn Lane						
Headway Factor	1.14	1.14	1.14	1.14	1.14	1.14
Turning Speed (mph)	15			9	15	9
Number of Detectors	1	2	2	1	1	1
Detector Template	Left	Thru	Thru	Right	Left	Right
Leading Detector (ft)	20	100	100	20	20	20
Trailing Detector (ft)	0	0	0	0	0	0
Detector 1 Position(ft)	0	0	0	0	0	0
Detector 1 Size(ft)	20	6	6	20	20	20
Detector 1 Type	Cl+Ex	Cl+Ex	Cl+Ex	Cl+Ex	Cl+Ex	Cl+Ex
Detector 1 Channel						
Detector 1 Extend (s)	0.0	0.0	0.0	0.0	0.0	0.0
Detector 1 Queue (s)	0.0	0.0	0.0	0.0	0.0	0.0
Detector 1 Delay (s)	0.0	0.0	0.0	0.0	0.0	0.0
Detector 2 Position(ft)		94	94			
Detector 2 Size(ft)		6	6			
Detector 2 Type		Cl+Ex	Cl+Ex			
Detector 2 Channel						
Detector 2 Extend (s)		0.0	0.0			
Turn Type	Prot	NA	NA	Prot	Prot	Prot
Protected Phases	1	6	2	2	8	8
Permitted Phases						

Lanes, Volumes, Timings  
2: McEwen /McEwen & Tower

11/18/2016

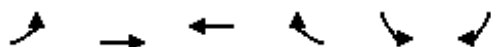

Lane Group	EBL	EBT	WBT	WBR	SBL	SBR
Detector Phase	1	6	2	2	8	8
Switch Phase						
Minimum Initial (s)	7.0	20.0	20.0	20.0	8.0	8.0
Minimum Split (s)	13.5	43.5	43.5	43.5	46.5	46.5
Total Split (s)	13.5	103.5	90.0	90.0	46.5	46.5
Total Split (%)	9.0%	69.0%	60.0%	60.0%	31.0%	31.0%
Maximum Green (s)	8.0	98.0	84.5	84.5	41.0	41.0
Yellow Time (s)	3.5	3.5	3.5	3.5	3.5	3.5
All-Red Time (s)	2.0	2.0	2.0	2.0	2.0	2.0
Lost Time Adjust (s)	0.0	0.0	0.0	0.0	0.0	0.0
Total Lost Time (s)	5.5	5.5	5.5	5.5	5.5	5.5
Lead/Lag	Lead		Lag	Lag		
Lead-Lag Optimize?						
Vehicle Extension (s)	3.0	3.0	3.0	3.0	3.0	3.0
Recall Mode	None	C-Min	C-Min	C-Min	None	None
Walk Time (s)		7.0	7.0	7.0	7.0	7.0
Flash Dont Walk (s)		18.0	18.0	18.0	34.0	34.0
Pedestrian Calls (#/hr)		3	3	3	3	3
Act Effct Green (s)	11.6	104.9	87.8	87.8	34.1	34.1
Actuated g/C Ratio	0.08	0.70	0.59	0.59	0.23	0.23
v/c Ratio	0.67	0.72	1.28	0.03	0.47	0.89
Control Delay	92.8	4.5	534.2	14.0	53.5	59.5
Queue Delay	0.0	0.0	0.0	0.0	0.0	1.1
Total Delay	92.8	4.5	534.2	14.0	53.5	60.6
LOS	F	A	F	B	D	E
Approach Delay		12.5	529.5		59.0	
Approach LOS		B	F		E	
90th %ile Green (s)	8.0	98.0	84.5	84.5	41.0	41.0
90th %ile Term Code	Max	Coord	Coord	Coord	Max	Max
70th %ile Green (s)	9.9	99.9	84.5	84.5	39.1	39.1
70th %ile Term Code	Max	Coord	Coord	Coord	Gap	Gap
50th %ile Green (s)	13.7	103.7	84.5	84.5	35.3	35.3
50th %ile Term Code	Max	Coord	Coord	Coord	Gap	Gap
30th %ile Green (s)	13.9	108.4	89.0	89.0	30.6	30.6
30th %ile Term Code	Gap	Coord	Coord	Coord	Gap	Gap
10th %ile Green (s)	12.4	114.4	96.5	96.5	24.6	24.6
10th %ile Term Code	Gap	Coord	Coord	Coord	Gap	Gap
Stops (vph)	133	514	2002	19	142	458
Fuel Used(gal)	5	20	288	0	3	13
CO Emissions (g/hr)	368	1365	20131	23	232	882
NOx Emissions (g/hr)	72	266	3917	4	45	172
VOC Emissions (g/hr)	85	316	4666	5	54	204
Dilemma Vehicles (#)	0	0	0	0	0	0
Queue Length 50th (ft)	73	37	~1582	4	144	255
Queue Length 95th (ft)	m#114	m73	m#1300	m4	238	#415
Internal Link Dist (ft)		1131	858		431	
Turn Bay Length (ft)	285			115	445	
Base Capacity (vph)	238	2226	1864	835	435	809
Starvation Cap Reductn	0	0	0	0	0	0

Lanes, Volumes, Timings  
 2: McEwen /McEwen & Tower

11/18/2016

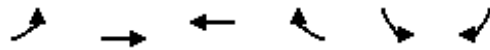

Lane Group	EBL	EBT	WBT	WBR	SBL	SBR
Spillback Cap Reductn	0	0	4	0	0	50
Storage Cap Reductn	0	0	0	0	0	0
Reduced v/c Ratio	0.67	0.72	1.28	0.03	0.39	0.83

Intersection Summary

Area Type: CBD  
 Cycle Length: 150  
 Actuated Cycle Length: 150  
 Offset: 66 (44%), Referenced to phase 2:WBT and 6:EBT, Start of Yellow  
 Natural Cycle: 105  
 Control Type: Actuated-Coordinated  
 Maximum v/c Ratio: 1.28  
 Intersection Signal Delay: 270.1 Intersection LOS: F  
 Intersection Capacity Utilization 106.8% ICU Level of Service G  
 Analysis Period (min) 60  
 ~ Volume exceeds capacity, queue is theoretically infinite.  
 Queue shown is maximum after two cycles.  
 # 95th percentile volume exceeds capacity, queue may be longer.  
 Queue shown is maximum after two cycles.  
 m Volume for 95th percentile queue is metered by upstream signal.

Splits and Phases: 2: McEwen /McEwen & Tower

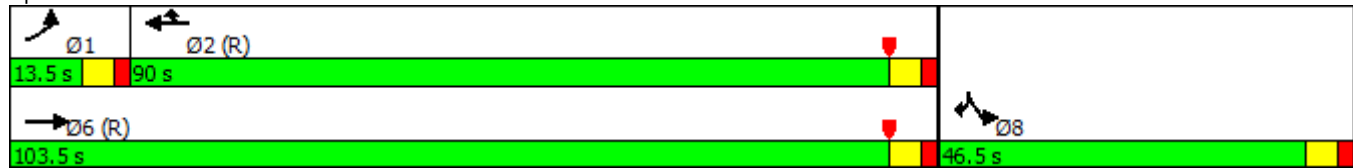

Lanes, Volumes, Timings  
3: Carothers/Carothers & McEwen

11/18/2016



Lane Group	EBL	EBT	EBR	WBL	WBT	WBR	NBL	NBT	NBR	SBL	SBT	SBR
Lane Configurations	↖↖	↗↗	↘	↖↖	↗↗	↘	↖↖	↗↗	↘	↖↖	↗↗	↘
Traffic Volume (vph)	249	940	540	95	886	188	364	412	98	342	1323	1111
Future Volume (vph)	249	940	540	95	886	188	364	412	98	342	1323	1111
Ideal Flow (vphpl)	1900	1900	1900	1900	1900	1900	1900	1900	1900	1900	1900	1900
Storage Length (ft)	205		205	218		97	300		300	280		310
Storage Lanes	2		1	2		1	2		1	2		1
Taper Length (ft)	25			25			25			25		
Lane Util. Factor	0.97	0.95	1.00	0.97	0.95	1.00	0.97	0.95	1.00	0.97	0.95	1.00
Frt			0.850			0.850			0.850			0.850
Flt Protected	0.950			0.950			0.950			0.950		
Satd. Flow (prot)	3433	3539	1583	3433	3539	1583	3433	3539	1583	3433	3539	1583
Flt Permitted	0.950			0.950			0.950			0.950		
Satd. Flow (perm)	3433	3539	1583	3433	3539	1583	3433	3539	1583	3433	3539	1583
Right Turn on Red			Yes			Yes			Yes			Yes
Satd. Flow (RTOR)			62			105			109			65
Link Speed (mph)		30			30			30				40
Link Distance (ft)		938			1960			1936				857
Travel Time (s)		21.3			44.5			44.0				14.6
Peak Hour Factor	1.00	1.00	1.00	1.00	1.00	1.00	1.00	1.00	1.00	1.00	1.00	1.00
Adj. Flow (vph)	249	940	540	95	886	188	364	412	98	342	1323	1111
Shared Lane Traffic (%)												
Lane Group Flow (vph)	249	940	540	95	886	188	364	412	98	342	1323	1111
Enter Blocked Intersection	No	No	No	No	No	No	No	No	No	No	No	No
Lane Alignment	Left	Left	Right	Left	Left	Right	Left	Left	Right	Left	Left	Right
Median Width(ft)		24			24			24				24
Link Offset(ft)		0			0			0				0
Crosswalk Width(ft)		16			16			16				16
Two way Left Turn Lane												
Headway Factor	1.00	1.00	1.00	1.00	1.00	1.00	1.00	1.00	1.00	1.00	1.00	1.00
Turning Speed (mph)	15		9	15		9	15		9	15		9
Number of Detectors	1	2	1	1	2	1	1	2	1	1	2	1
Detector Template	Left	Thru	Right	Left	Thru	Right	Left	Thru	Right	Left	Thru	Right
Leading Detector (ft)	20	100	20	20	100	20	20	100	20	20	100	20
Trailing Detector (ft)	0	0	0	0	0	0	0	0	0	0	0	0
Detector 1 Position(ft)	0	0	0	0	0	0	0	0	0	0	0	0
Detector 1 Size(ft)	20	6	20	20	6	20	20	6	20	20	6	20
Detector 1 Type	Cl+Ex	Cl+Ex	Cl+Ex	Cl+Ex	Cl+Ex	Cl+Ex	Cl+Ex	Cl+Ex	Cl+Ex	Cl+Ex	Cl+Ex	Cl+Ex
Detector 1 Channel												
Detector 1 Extend (s)	0.0	0.0	0.0	0.0	0.0	0.0	0.0	0.0	0.0	0.0	0.0	0.0
Detector 1 Queue (s)	0.0	0.0	0.0	0.0	0.0	0.0	0.0	0.0	0.0	0.0	0.0	0.0
Detector 1 Delay (s)	0.0	0.0	0.0	0.0	0.0	0.0	0.0	0.0	0.0	0.0	0.0	0.0
Detector 2 Position(ft)		94			94			94				94
Detector 2 Size(ft)		6			6			6				6
Detector 2 Type		Cl+Ex			Cl+Ex			Cl+Ex				Cl+Ex
Detector 2 Channel												
Detector 2 Extend (s)		0.0			0.0			0.0				0.0
Turn Type	Prot	NA	pm+ov	Prot	NA	pm+ov	Prot	NA	custom	Prot	NA	custom
Protected Phases	1	6	7	5	2	3	7	4	5	3	8	1
Permitted Phases			6			2			8			4

Lanes, Volumes, Timings  
 3: Carothers/Carothers & McEwen

11/18/2016



Lane Group	EBL	EBT	EBR	WBL	WBT	WBR	NBL	NBT	NBR	SBL	SBT	SBR
Detector Phase	1	6	7	5	2	3	7	4	5	3	8	1
Switch Phase												
Minimum Initial (s)	6.0	13.0	6.0	4.0	13.0	6.0	6.0	13.0	4.0	6.0	13.0	6.0
Minimum Split (s)	13.0	52.0	12.5	10.0	52.0	13.0	12.5	52.0	10.0	13.0	52.0	13.0
Total Split (s)	24.0	64.0	18.0	14.0	54.0	20.0	18.0	52.0	14.0	20.0	54.0	24.0
Total Split (%)	16.0%	42.7%	12.0%	9.3%	36.0%	13.3%	12.0%	34.7%	9.3%	13.3%	36.0%	16.0%
Maximum Green (s)	18.0	58.0	12.0	8.5	48.0	14.0	12.0	46.0	8.5	14.0	48.0	18.0
Yellow Time (s)	4.0	4.0	4.0	3.5	4.0	4.0	4.0	4.0	3.5	4.0	4.0	4.0
All-Red Time (s)	2.0	2.0	2.0	2.0	2.0	2.0	2.0	2.0	2.0	2.0	2.0	2.0
Lost Time Adjust (s)	0.0	0.0	0.0	0.0	0.0	0.0	0.0	0.0	0.0	0.0	0.0	0.0
Total Lost Time (s)	6.0	6.0	6.0	5.5	6.0	6.0	6.0	6.0	5.5	6.0	6.0	6.0
Lead/Lag	Lead	Lag	Lead	Lead	Lag	Lead	Lead	Lag	Lead	Lead	Lag	Lead
Lead-Lag Optimize?												
Vehicle Extension (s)	3.0	3.0	3.0	3.0	3.0	3.0	3.0	3.0	3.0	3.0	3.0	3.0
Recall Mode	Max	C-Max	None	None	C-Max	None	None	None	None	None	None	Max
Walk Time (s)		7.0			7.0			7.0			7.0	
Flash Dont Walk (s)		39.0			39.0			37.0			37.0	
Pedestrian Calls (#/hr)		5			5			5			5	
Act Effct Green (s)	18.0	58.3	76.3	8.2	48.0	68.0	12.0	46.0	62.2	14.0	48.0	70.0
Actuated g/C Ratio	0.12	0.39	0.51	0.05	0.32	0.45	0.08	0.31	0.41	0.09	0.32	0.47
v/c Ratio	0.61	0.68	0.65	0.51	0.78	0.24	1.33	0.38	0.14	1.07	1.17	1.44
Control Delay	65.9	24.2	21.5	70.1	45.5	11.5	666.8	42.1	3.9	245.2	359.0	825.1
Queue Delay	0.0	0.0	0.0	0.0	4.3	0.0	0.0	0.0	0.0	0.0	0.0	5.2
Total Delay	65.9	24.2	21.5	70.1	49.8	11.5	666.8	42.1	3.9	245.2	359.0	830.3
LOS	E	C	C	E	D	B	F	D	A	F	F	F
Approach Delay		29.3			45.3			298.0			533.6	
Approach LOS		C			D			F			F	
90th %ile Green (s)	18.0	58.0	12.0	8.5	48.0	14.0	12.0	46.0	8.5	14.0	48.0	18.0
90th %ile Term Code	MaxR	Coord	Max	Max	Coord	Max	Max	Hold	Max	Max	Max	MaxR
70th %ile Green (s)	18.0	58.0	12.0	8.5	48.0	14.0	12.0	46.0	8.5	14.0	48.0	18.0
70th %ile Term Code	MaxR	Coord	Max	Max	Coord	Max	Max	Hold	Max	Max	Max	MaxR
50th %ile Green (s)	18.0	58.0	12.0	8.5	48.0	14.0	12.0	46.0	8.5	14.0	48.0	18.0
50th %ile Term Code	MaxR	Coord	Max	Max	Coord	Max	Max	Hold	Max	Max	Max	MaxR
30th %ile Green (s)	18.0	58.1	12.0	8.4	48.0	14.0	12.0	46.0	8.4	14.0	48.0	18.0
30th %ile Term Code	MaxR	Coord	Max	Gap	Coord	Max	Max	Hold	Gap	Max	Max	MaxR
10th %ile Green (s)	18.0	59.6	12.0	6.9	48.0	14.0	12.0	46.0	6.9	14.0	48.0	18.0
10th %ile Term Code	MaxR	Coord	Max	Gap	Coord	Max	Max	Hold	Gap	Max	Max	MaxR
Stops (vph)	225	633	416	90	706	69	330	317	8	308	1214	975
Fuel Used(gal)	6	15	9	3	26	4	57	11	2	22	116	203
CO Emissions (g/hr)	448	1049	602	231	1793	258	3965	804	112	1544	8130	14166
NOx Emissions (g/hr)	87	204	117	45	349	50	772	156	22	300	1582	2756
VOC Emissions (g/hr)	104	243	139	54	415	60	919	186	26	358	1884	3283
Dilemma Vehicles (#)	0	0	0	0	0	0	0	0	0	0	38	0
Queue Length 50th (ft)	109	330	315	46	380	52	~237	166	0	~190	~807	~1442
Queue Length 95th (ft)	m165	460	712	m68	m480	m86	#397	246	41	#345	#1120	#1995
Internal Link Dist (ft)		858			1880			1856			777	
Turn Bay Length (ft)	205		205	218		97	300		300	280		310
Base Capacity (vph)	411	1376	835	194	1132	775	274	1085	723	320	1132	773
Starvation Cap Reductn	0	0	0	0	0	0	0	0	0	0	0	0

Lanes, Volumes, Timings  
 3: Carothers/Carothers & McEwen

11/18/2016

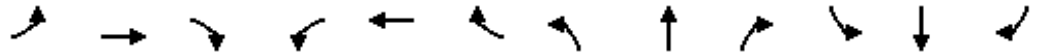

Lane Group	EBL	EBT	EBR	WBL	WBT	WBR	NBL	NBT	NBR	SBL	SBT	SBR
Spillback Cap Reductn	0	0	0	0	167	0	0	0	0	0	0	332
Storage Cap Reductn	0	0	0	0	0	0	0	0	0	0	0	0
Reduced v/c Ratio	0.61	0.68	0.65	0.49	0.92	0.24	1.33	0.38	0.14	1.07	1.17	2.52

Intersection Summary

Area Type: Other  
 Cycle Length: 150  
 Actuated Cycle Length: 150  
 Offset: 78 (52%), Referenced to phase 2:WBT and 6:EBT, Start of Yellow  
 Natural Cycle: 130  
 Control Type: Actuated-Coordinated  
 Maximum v/c Ratio: 1.44  
 Intersection Signal Delay: 281.8      Intersection LOS: F  
 Intersection Capacity Utilization 118.7%      ICU Level of Service H  
 Analysis Period (min) 60  
 ~ Volume exceeds capacity, queue is theoretically infinite.  
 Queue shown is maximum after two cycles.  
 # 95th percentile volume exceeds capacity, queue may be longer.  
 Queue shown is maximum after two cycles.  
 m Volume for 95th percentile queue is metered by upstream signal.

Splits and Phases: 3: Carothers/Carothers & McEwen

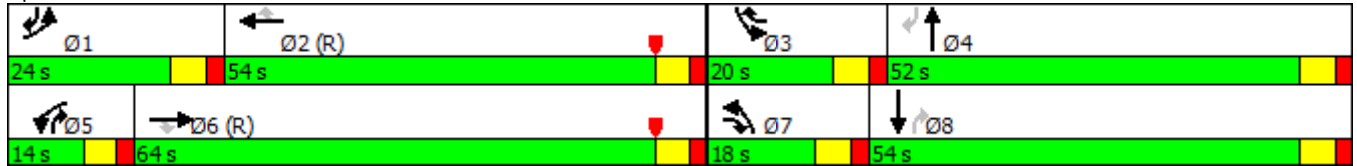



Lanes, Volumes, Timings  
4: Ovation/Resource Parkway & McEwen

11/18/2016



Lane Group	EBL	EBT	EBR	WBL	WBT	WBR	NBL	NBT	NBR	SBL	SBT	SBR
Lane Configurations												
Traffic Volume (vph)	178	1029	181	101	379	43	603	124	86	135	81	272
Future Volume (vph)	178	1029	181	101	379	43	603	124	86	135	81	272
Ideal Flow (vphpl)	1900	1900	1900	1900	1900	1900	1900	1900	1900	1900	1900	1900
Lane Util. Factor	1.00	0.95	1.00	1.00	0.95	0.95	0.97	1.00	1.00	1.00	1.00	1.00
Frt			0.850		0.985				0.850		0.884	
Flt Protected	0.950			0.950			0.950			0.950		
Satd. Flow (prot)	1770	3539	1583	1770	3486	0	3433	1863	1583	1770	1647	0
Flt Permitted	0.386			0.171			0.192			0.677		
Satd. Flow (perm)	719	3539	1583	319	3486	0	694	1863	1583	1261	1647	0
Right Turn on Red			Yes			Yes			Yes			Yes
Satd. Flow (RTOR)			181		17				86		205	
Link Speed (mph)		30			30			30			30	
Link Distance (ft)		1960			345			402			456	
Travel Time (s)		44.5			7.8			9.1			10.4	
Peak Hour Factor	1.00	1.00	1.00	1.00	1.00	1.00	1.00	1.00	1.00	1.00	1.00	1.00
Adj. Flow (vph)	178	1029	181	101	379	43	603	124	86	135	81	272
Shared Lane Traffic (%)												
Lane Group Flow (vph)	178	1029	181	101	422	0	603	124	86	135	353	0
Enter Blocked Intersection	No	No	No	No	No	No	No	No	No	No	No	No
Lane Alignment	Left	Left	Right	Left	Left	Right	Left	Left	Right	Left	Left	Right
Median Width(ft)		36			36			24			24	
Link Offset(ft)		0			0			0			0	
Crosswalk Width(ft)		16			16			16			16	
Two way Left Turn Lane												
Headway Factor	1.00	1.00	1.00	1.00	1.00	1.00	1.00	1.00	1.00	1.00	1.00	1.00
Turning Speed (mph)	15		9	15		9	15		9	15		9
Number of Detectors	1	2	1	1	2		1	2	1	1	2	
Detector Template	Left	Thru	Right	Left	Thru		Left	Thru	Right	Left	Thru	
Leading Detector (ft)	20	100	20	20	100		20	100	20	20	100	
Trailing Detector (ft)	0	0	0	0	0		0	0	0	0	0	
Detector 1 Position(ft)	0	0	0	0	0		0	0	0	0	0	
Detector 1 Size(ft)	20	6	20	20	6		20	6	20	20	6	
Detector 1 Type	Cl+Ex	Cl+Ex	Cl+Ex	Cl+Ex	Cl+Ex		Cl+Ex	Cl+Ex	Cl+Ex	Cl+Ex	Cl+Ex	
Detector 1 Channel												
Detector 1 Extend (s)	0.0	0.0	0.0	0.0	0.0		0.0	0.0	0.0	0.0	0.0	
Detector 1 Queue (s)	0.0	0.0	0.0	0.0	0.0		0.0	0.0	0.0	0.0	0.0	
Detector 1 Delay (s)	0.0	0.0	0.0	0.0	0.0		0.0	0.0	0.0	0.0	0.0	
Detector 2 Position(ft)		94			94			94			94	
Detector 2 Size(ft)		6			6			6			6	
Detector 2 Type		Cl+Ex			Cl+Ex			Cl+Ex			Cl+Ex	
Detector 2 Channel												
Detector 2 Extend (s)		0.0			0.0			0.0			0.0	
Turn Type	pm+pt	NA	pm+ov	pm+pt	NA		pm+pt	NA	pm+ov	pm+pt	NA	
Protected Phases	3	8	1	7	4		1	6	7	5	2	
Permitted Phases	8		8	4			6		6	2		
Detector Phase	3	8	1	7	4		1	6	7	5	2	
Switch Phase												
Minimum Initial (s)	4.0	4.0	4.0	4.0	4.0		4.0	4.0	4.0	4.0	4.0	

Lanes, Volumes, Timings  
4: Ovation/Resource Parkway & McEwen

11/18/2016



Lane Group	EBL	EBT	EBR	WBL	WBT	WBR	NBL	NBT	NBR	SBL	SBT	SBR
Minimum Split (s)	10.0	20.0	10.0	10.0	20.0		10.0	20.0	10.0	10.0	20.0	
Total Split (s)	12.0	30.0	15.0	10.0	28.0		15.0	25.0	10.0	10.0	20.0	
Total Split (%)	16.0%	40.0%	20.0%	13.3%	37.3%		20.0%	33.3%	13.3%	13.3%	26.7%	
Maximum Green (s)	8.0	26.0	11.0	6.0	24.0		11.0	21.0	6.0	6.0	16.0	
Yellow Time (s)	3.5	3.5	3.5	3.5	3.5		3.5	3.5	3.5	3.5	3.5	
All-Red Time (s)	0.5	0.5	0.5	0.5	0.5		0.5	0.5	0.5	0.5	0.5	
Lost Time Adjust (s)	0.0	0.0	0.0	0.0	0.0		0.0	0.0	0.0	0.0	0.0	
Total Lost Time (s)	4.0	4.0	4.0	4.0	4.0		4.0	4.0	4.0	4.0	4.0	
Lead/Lag	Lead	Lag	Lead	Lead	Lag		Lead	Lag	Lead	Lead	Lag	
Lead-Lag Optimize?												
Vehicle Extension (s)	3.0	3.0	3.0	3.0	3.0		3.0	3.0	3.0	3.0	3.0	
Recall Mode	None	C-Max	None	None	C-Max		None	Max	None	None	Max	
Walk Time (s)		5.0			5.0			5.0			5.0	
Flash Dont Walk (s)		11.0			11.0			11.0			11.0	
Pedestrian Calls (#/hr)		10			10			10			10	
Act Effect Green (s)	34.4	28.0	43.0	30.2	24.2		31.0	23.0	32.9	22.0	16.0	
Actuated g/C Ratio	0.46	0.37	0.57	0.40	0.32		0.41	0.31	0.44	0.29	0.21	
v/c Ratio	0.41	0.78	0.18	0.42	0.37		0.88	0.22	0.12	0.33	0.69	
Control Delay	10.5	20.4	2.1	16.7	19.9		34.9	21.9	4.0	17.4	19.7	
Queue Delay	0.0	0.0	0.0	0.0	0.0		0.0	0.0	0.0	0.0	0.0	
Total Delay	10.5	20.4	2.1	16.7	19.9		34.9	21.9	4.0	17.4	19.7	
LOS	B	C	A	B	B		C	C	A	B	B	
Approach Delay		16.8			19.3			29.6			19.1	
Approach LOS		B			B			C			B	
90th %ile Green (s)	8.0	26.0	11.0	6.0	24.0		11.0	21.0	6.0	6.0	16.0	
90th %ile Term Code	Max	Coord	Max	Max	Coord		Max	MaxR	Max	Max	MaxR	
70th %ile Green (s)	8.0	26.0	11.0	6.0	24.0		11.0	21.0	6.0	6.0	16.0	
70th %ile Term Code	Max	Coord	Max	Max	Coord		Max	MaxR	Max	Max	MaxR	
50th %ile Green (s)	8.0	26.0	11.0	6.0	24.0		11.0	21.0	6.0	6.0	16.0	
50th %ile Term Code	Max	Coord	Max	Max	Coord		Max	MaxR	Max	Max	MaxR	
30th %ile Green (s)	8.0	26.0	11.0	6.0	24.0		11.0	21.0	6.0	6.0	16.0	
30th %ile Term Code	Max	Coord	Max	Max	Coord		Max	MaxR	Max	Max	MaxR	
10th %ile Green (s)	6.8	36.0	11.0	0.0	25.2		11.0	31.0	0.0	0.0	16.0	
10th %ile Term Code	Gap	Coord	Max	Skip	Coord		Max	MaxR	Skip	Skip	MaxR	
Stops (vph)	80	704	33	57	299		388	93	14	96	146	
Fuel Used(gal)	4	24	3	1	4		8	1	0	1	3	
CO Emissions (g/hr)	248	1670	211	65	315		581	102	29	104	243	
NOx Emissions (g/hr)	48	325	41	13	61		113	20	6	20	47	
VOC Emissions (g/hr)	57	387	49	15	73		135	24	7	24	56	
Dilemma Vehicles (#)	0	0	0	0	0		0	0	0	0	0	
Queue Length 50th (ft)	48	267	21	25	75		99	44	0	39	60	
Queue Length 95th (ft)	m97	m363	m39	57	128		#227	97	30	83	#224	
Internal Link Dist (ft)		1880			265			322			376	
Turn Bay Length (ft)												
Base Capacity (vph)	442	1320	984	244	1138		688	571	744	410	512	
Starvation Cap Reductn	0	0	0	0	0		0	0	0	0	0	
Spillback Cap Reductn	0	0	0	0	0		0	0	0	0	0	
Storage Cap Reductn	0	0	0	0	0		0	0	0	0	0	
Reduced v/c Ratio	0.40	0.78	0.18	0.41	0.37		0.88	0.22	0.12	0.33	0.69	

Intersection Summary





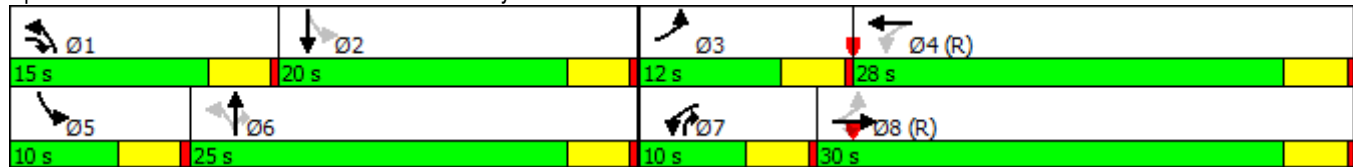



















Area Type:	Other
Cycle Length:	75
Actuated Cycle Length:	75
Offset:	70 (93%), Referenced to phase 4:WBTL and 8:EBTL, Start of Green
Natural Cycle:	70
Control Type:	Actuated-Coordinated
Maximum v/c Ratio:	0.88
Intersection Signal Delay:	20.8
Intersection LOS:	C
Intersection Capacity Utilization:	85.6%
ICU Level of Service:	E
Analysis Period (min):	60
#	95th percentile volume exceeds capacity, queue may be longer. Queue shown is maximum after two cycles.
m	Volume for 95th percentile queue is metered by upstream signal.

Splits and Phases: 4: Ovation/Resource Parkway & McEwen



Lanes, Volumes, Timings  
5: Carothers /Carothers & Tower/Pacific

11/18/2016

												
Lane Group	EBL	EBT	EBR	WBL	WBT	WBR	NBL	NBT	NBR	SBL	SBT	SBR
Lane Configurations												
Traffic Volume (vph)	395	1	213	145	0	54	68	667	124	31	2343	120
Future Volume (vph)	395	1	213	145	0	54	68	667	124	31	2343	120
Ideal Flow (vphpl)	1900	1900	1900	1900	1900	1900	1900	1900	1900	1900	1900	1900
Grade (%)		0%			0%			2%			0%	
Storage Length (ft)	84		78	106		77	177		100	85		144
Storage Lanes	2		1	1		1	1		1	1		1
Taper Length (ft)	25			25			25			25		
Lane Util. Factor	0.97	1.00	1.00	1.00	1.00	1.00	1.00	0.95	1.00	1.00	0.95	1.00
Fr <sub>t</sub>			0.850				0.850			0.850		0.850
Fl <sub>t</sub> Protected	0.950			0.950			0.950			0.950		
Satd. Flow (prot)	3433	1863	1583	1770	1863	1583	1752	3504	1567	1770	3539	1583
Fl <sub>t</sub> Permitted	0.950			0.950			0.051			0.361		
Satd. Flow (perm)	3433	1863	1583	1770	1863	1583	94	3504	1567	672	3539	1583
Right Turn on Red			Yes			Yes			Yes			Yes
Satd. Flow (RTOR)			109			199			105			105
Link Speed (mph)		30			30			40			30	
Link Distance (ft)		881			890			857			905	
Travel Time (s)		20.0			20.2			14.6			20.6	
Peak Hour Factor	1.00	1.00	1.00	1.00	1.00	1.00	1.00	1.00	1.00	1.00	1.00	1.00
Adj. Flow (vph)	395	1	213	145	0	54	68	667	124	31	2343	120
Shared Lane Traffic (%)												
Lane Group Flow (vph)	395	1	213	145	0	54	68	667	124	31	2343	120
Enter Blocked Intersection	No	No	No	No	No	No	No	No	No	No	No	No
Lane Alignment	Left	Left	Right	Left	Left	Right	Left	Left	Right	Left	Left	Right
Median Width(ft)		24			24			24			24	
Link Offset(ft)		0			0			0			0	
Crosswalk Width(ft)		16			16			16			16	
Two way Left Turn Lane												
Headway Factor	1.00	1.00	1.00	1.00	1.00	1.00	1.01	1.01	1.01	1.00	1.00	1.00
Turning Speed (mph)	15		9	15		9	15		9	15		9
Number of Detectors	1	2	1	1	2	1	1	2	1	1	2	1
Detector Template	Left	Thru	Right	Left	Thru	Right	Left	Thru	Right	Left	Thru	Right
Leading Detector (ft)	20	100	20	20	100	20	20	100	20	20	100	20
Trailing Detector (ft)	0	0	0	0	0	0	0	0	0	0	0	0
Detector 1 Position(ft)	0	0	0	0	0	0	0	0	0	0	0	0
Detector 1 Size(ft)	20	6	20	20	6	20	20	6	20	20	6	20
Detector 1 Type	Cl+Ex	Cl+Ex	Cl+Ex	Cl+Ex	Cl+Ex	Cl+Ex	Cl+Ex	Cl+Ex	Cl+Ex	Cl+Ex	Cl+Ex	Cl+Ex
Detector 1 Channel												
Detector 1 Extend (s)	0.0	0.0	0.0	0.0	0.0	0.0	0.0	0.0	0.0	0.0	0.0	0.0
Detector 1 Queue (s)	0.0	0.0	0.0	0.0	0.0	0.0	0.0	0.0	0.0	0.0	0.0	0.0
Detector 1 Delay (s)	0.0	0.0	0.0	0.0	0.0	0.0	0.0	0.0	0.0	0.0	0.0	0.0
Detector 2 Position(ft)		94			94			94			94	
Detector 2 Size(ft)		6			6			6			6	
Detector 2 Type		Cl+Ex			Cl+Ex			Cl+Ex			Cl+Ex	
Detector 2 Channel												
Detector 2 Extend (s)		0.0			0.0			0.0			0.0	
Turn Type	Prot	NA	Perm	Prot		Perm	pm+pt	NA	Perm	pm+pt	NA	Perm
Protected Phases	3	8		7	4		1	6		5	2	

Lanes, Volumes, Timings  
5: Carothers /Carothers & Tower/Pacific

11/18/2016



Lane Group	EBL	EBT	EBR	WBL	WBT	WBR	NBL	NBT	NBR	SBL	SBT	SBR
Permitted Phases			8			4	6		6	2		2
Detector Phase	3	8	8	7	4	4	1	6	6	5	2	2
Switch Phase												
Minimum Initial (s)	6.0	8.0	8.0	6.0	8.0	8.0	6.0	20.0	20.0	6.0	20.0	20.0
Minimum Split (s)	12.5	48.5	48.5	12.5	48.5	48.5	12.0	42.0	42.0	12.0	42.0	42.0
Total Split (s)	16.0	50.5	50.5	14.0	48.5	48.5	12.0	63.5	63.5	12.0	63.5	63.5
Total Split (%)	11.4%	36.1%	36.1%	10.0%	34.6%	34.6%	8.6%	45.4%	45.4%	8.6%	45.4%	45.4%
Maximum Green (s)	10.5	45.0	45.0	8.5	43.0	43.0	6.5	57.5	57.5	6.5	57.5	57.5
Yellow Time (s)	3.5	3.5	3.5	3.5	3.5	3.5	3.5	4.0	4.0	3.5	4.0	4.0
All-Red Time (s)	2.0	2.0	2.0	2.0	2.0	2.0	2.0	2.0	2.0	2.0	2.0	2.0
Lost Time Adjust (s)	0.0	0.0	0.0	0.0	0.0	0.0	0.0	0.0	0.0	0.0	0.0	0.0
Total Lost Time (s)	5.5	5.5	5.5	5.5	5.5	5.5	5.5	6.0	6.0	5.5	6.0	6.0
Lead/Lag	Lead	Lag	Lag	Lead	Lag	Lag	Lead	Lag	Lag	Lead	Lag	Lag
Lead-Lag Optimize?												
Vehicle Extension (s)	3.0	3.0	3.0	3.0	3.0	3.0	3.0	3.0	3.0	3.0	3.0	3.0
Recall Mode	None	None	None	None	None	None	None	C-Min	C-Min	None	C-Min	C-Min
Walk Time (s)		7.0	7.0		7.0	7.0		7.0	7.0		7.0	7.0
Flash Dont Walk (s)		36.0	36.0		36.0	36.0		29.0	29.0		29.0	29.0
Pedestrian Calls (#/hr)		10	10		10	10		10	10		10	10
Act Effct Green (s)	12.8	25.0	25.0	8.5		23.4	86.9	82.4	82.4	85.4	79.8	79.8
Actuated g/C Ratio	0.09	0.18	0.18	0.06		0.17	0.62	0.59	0.59	0.61	0.57	0.57
v/c Ratio	1.26	0.00	0.57	1.36		0.13	0.50	0.32	0.13	0.07	1.16	0.13
Control Delay	543.9	34.0	28.3	745.1		0.6	33.4	19.4	6.4	2.3	312.1	0.5
Queue Delay	0.0	0.0	0.0	0.0		0.0	0.0	0.0	0.0	0.0	0.0	0.0
Total Delay	543.9	34.0	28.3	745.1		0.6	33.4	19.4	6.4	2.3	312.1	0.5
LOS	F	C	C	F		A	C	B	A	A	F	A
Approach Delay		362.7						18.6			293.2	
Approach LOS		F						B			F	
90th %ile Green (s)	10.5	45.0	45.0	8.5	43.0	43.0	6.5	57.5	57.5	6.5	57.5	57.5
90th %ile Term Code	Max	Hold	Hold	Max	Ped	Ped	Max	Coord	Coord	Max	Coord	Coord
70th %ile Green (s)	10.5	45.0	45.0	8.5	43.0	43.0	6.5	57.5	57.5	6.5	57.5	57.5
70th %ile Term Code	Max	Hold	Hold	Max	Ped	Ped	Max	Coord	Coord	Max	Coord	Coord
50th %ile Green (s)	10.5	15.3	15.3	8.5	13.3	13.3	7.1	87.5	87.5	6.2	86.6	86.6
50th %ile Term Code	Max	Gap	Gap	Max	Hold	Hold	Gap	Coord	Coord	Gap	Coord	Coord
30th %ile Green (s)	10.5	11.6	11.6	8.5	9.6	9.6	6.4	102.9	102.9	0.0	91.0	91.0
30th %ile Term Code	Max	Gap	Gap	Max	Hold	Hold	Gap	Coord	Coord	Skip	Coord	Coord
10th %ile Green (s)	22.0	8.0	8.0	8.5	0.0	0.0	0.0	106.5	106.5	0.0	106.5	106.5
10th %ile Term Code	Hold	Min	Min	Max	Skip	Skip	Skip	Coord	Coord	Skip	Coord	Coord
Stops (vph)	311	2	89	130		0	33	349	18	3	1624	5
Fuel Used(gal)	48	0	3	24		0	1	10	1	0	174	1
CO Emissions (g/hr)	3367	2	223	1658		27	83	695	74	17	12188	62
NOx Emissions (g/hr)	655	0	43	323		5	16	135	14	3	2371	12
VOC Emissions (g/hr)	780	0	52	384		6	19	161	17	4	2825	14
Dilemma Vehicles (#)	0	0	0	0		0	0	24	0	0	0	0
Queue Length 50th (ft)	~259	1	94	~172		0	17	140	6	2	~1243	10
Queue Length 95th (ft)	#421	6	172	#361		0	#108	329	64	m2	m#1721	m1
Internal Link Dist (ft)		801			810			777			825	
Turn Bay Length (ft)	84		78	106		77	177		100	85		144
Base Capacity (vph)	313	598	582	107		624	136	2062	965	461	2017	947

Lanes, Volumes, Timings  
 5: Carothers /Carothers & Tower/Pacific

11/18/2016



Lane Group	EBL	EBT	EBR	WBL	WBT	WBR	NBL	NBT	NBR	SBL	SBT	SBR
Starvation Cap Reductn	0	0	0	0		0	0	0	0	0	0	0
Spillback Cap Reductn	0	0	0	0		0	0	0	0	0	0	0
Storage Cap Reductn	0	0	0	0		0	0	0	0	0	0	0
Reduced v/c Ratio	1.26	0.00	0.37	1.36		0.09	0.50	0.32	0.13	0.07	1.16	0.13

Intersection Summary

Area Type: Other  
 Cycle Length: 140  
 Actuated Cycle Length: 140  
 Offset: 16 (11%), Referenced to phase 2:SBTL and 6:NBTL, Start of Yellow  
 Natural Cycle: 115  
 Control Type: Actuated-Coordinated  
 Maximum v/c Ratio: 1.36  
 Intersection Signal Delay: 258.7 Intersection LOS: F  
 Intersection Capacity Utilization 100.2% ICU Level of Service G  
 Analysis Period (min) 60  
 ~ Volume exceeds capacity, queue is theoretically infinite.  
 Queue shown is maximum after two cycles.  
 # 95th percentile volume exceeds capacity, queue may be longer.  
 Queue shown is maximum after two cycles.  
 m Volume for 95th percentile queue is metered by upstream signal.

Splits and Phases: 5: Carothers /Carothers & Tower/Pacific

Ø1	Ø2 (R)	Ø3	Ø4
12 s	63.5 s	16 s	48.5 s
Ø5	Ø6 (R)	Ø7	Ø8
12 s	63.5 s	14 s	50.5 s

Lanes, Volumes, Timings  
6: Carothers/Carothers Parkway & Apartments/Resource

11/18/2016



Lane Group	EBL	EBT	EBR	WBL	WBT	WBR	NBL	NBT	NBR	SBL	SBT	SBR
Lane Configurations												
Traffic Volume (vph)	127	0	194	8	0	172	47	1096	3	150	2257	66
Future Volume (vph)	127	0	194	8	0	172	47	1096	3	150	2257	66
Ideal Flow (vphpl)	1900	1900	1900	1900	1900	1900	1900	1900	1900	1900	1900	1900
Grade (%)		0%			0%			2%			0%	
Storage Length (ft)	0		0	0		0	210		128	480		93
Storage Lanes	1		0	1		1	1		0	1		1
Taper Length (ft)	25			25			25			25		
Lane Util. Factor	1.00	1.00	1.00	1.00	1.00	1.00	1.00	0.95	0.95	1.00	0.95	1.00
Fr <sub>t</sub>		0.850				0.850						0.850
Fl <sub>t</sub> Protected	0.950			0.950			0.950			0.950		
Satd. Flow (prot)	1770	1583	0	1770	1863	1583	1752	3504	0	1770	3539	1583
Fl <sub>t</sub> Permitted	0.590			0.518			0.048			0.181		
Satd. Flow (perm)	1099	1583	0	965	1863	1583	89	3504	0	337	3539	1583
Right Turn on Red			Yes			Yes			Yes			Yes
Satd. Flow (RTOR)		192				82						62
Link Speed (mph)		30			30			40				40
Link Distance (ft)		762			773			905				2004
Travel Time (s)		17.3			17.6			15.4				34.2
Peak Hour Factor	1.00	1.00	1.00	1.00	1.00	1.00	1.00	1.00	1.00	1.00	1.00	1.00
Adj. Flow (vph)	127	0	194	8	0	172	47	1096	3	150	2257	66
Shared Lane Traffic (%)												
Lane Group Flow (vph)	127	194	0	8	0	172	47	1099	0	150	2257	66
Enter Blocked Intersection	No	No	No	No	No	No	No	No	No	No	No	No
Lane Alignment	Left	Left	Right	Left	Left	Right	Left	Left	Right	Left	Left	Right
Median Width(ft)		12			12			12				12
Link Offset(ft)		0			0			0				0
Crosswalk Width(ft)		16			16			16				16
Two way Left Turn Lane												
Headway Factor	1.00	1.00	1.00	1.00	1.00	1.00	1.01	1.01	1.01	1.00	1.00	1.00
Turning Speed (mph)	15		9	15		9	15		9	15		9
Number of Detectors	1	2		1	2	1	1	2		1	2	1
Detector Template	Left	Thru		Left	Thru	Right	Left	Thru		Left	Thru	Right
Leading Detector (ft)	20	100		20	100	20	20	100		20	100	20
Trailing Detector (ft)	0	0		0	0	0	0	0		0	0	0
Detector 1 Position(ft)	0	0		0	0	0	0	0		0	0	0
Detector 1 Size(ft)	20	6		20	6	20	20	6		20	6	20
Detector 1 Type	Cl+Ex	Cl+Ex		Cl+Ex	Cl+Ex	Cl+Ex	Cl+Ex	Cl+Ex		Cl+Ex	Cl+Ex	Cl+Ex
Detector 1 Channel												
Detector 1 Extend (s)	0.0	0.0		0.0	0.0	0.0	0.0	0.0		0.0	0.0	0.0
Detector 1 Queue (s)	0.0	0.0		0.0	0.0	0.0	0.0	0.0		0.0	0.0	0.0
Detector 1 Delay (s)	0.0	0.0		0.0	0.0	0.0	0.0	0.0		0.0	0.0	0.0
Detector 2 Position(ft)		94			94			94				94
Detector 2 Size(ft)		6			6			6				6
Detector 2 Type		Cl+Ex			Cl+Ex			Cl+Ex				Cl+Ex
Detector 2 Channel												
Detector 2 Extend (s)		0.0			0.0			0.0				0.0
Turn Type	pm+pt	NA		pm+pt		pm+ov	pm+pt	NA		pm+pt	NA	pm+ov
Protected Phases	3	8		7	4	5	1	6		5	2	3

Lanes, Volumes, Timings  
6: Carothers/Carothers Parkway & Apartments/Resource

11/18/2016



Lane Group	EBL	EBT	EBR	WBL	WBT	WBR	NBL	NBT	NBR	SBL	SBT	SBR
Permitted Phases	8			4		4	6			2		2
Detector Phase	3	8		7	4	5	1	6		5	2	3
Switch Phase												
Minimum Initial (s)	5.0	6.0		5.0	6.0	5.0	5.0	15.0		5.0	15.0	5.0
Minimum Split (s)	12.0	48.5		12.0	48.5	11.5	11.5	48.0		11.5	48.0	12.0
Total Split (s)	12.0	48.5		12.0	48.5	16.4	11.5	63.1		16.4	68.0	12.0
Total Split (%)	8.6%	34.6%		8.6%	34.6%	11.7%	8.2%	45.1%		11.7%	48.6%	8.6%
Maximum Green (s)	6.5	43.0		6.5	43.0	10.9	6.0	57.1		10.9	62.0	6.5
Yellow Time (s)	3.5	3.5		3.5	3.5	3.5	3.5	4.0		3.5	4.0	3.5
All-Red Time (s)	2.0	2.0		2.0	2.0	2.0	2.0	2.0		2.0	2.0	2.0
Lost Time Adjust (s)	0.0	0.0		0.0	0.0	0.0	0.0	0.0		0.0	0.0	0.0
Total Lost Time (s)	5.5	5.5		5.5	5.5	5.5	5.5	6.0		5.5	6.0	5.5
Lead/Lag	Lead	Lag		Lead	Lag	Lead	Lead	Lag		Lead	Lag	Lead
Lead-Lag Optimize?												
Vehicle Extension (s)	3.0	3.0		3.0	3.0	3.0	3.0	3.0		3.0	3.0	3.0
Recall Mode	None	None		None	None	None	None	C-Max		None	C-Max	None
Walk Time (s)		7.0			7.0			7.0			7.0	
Flash Dont Walk (s)		36.0			36.0			35.0			35.0	
Pedestrian Calls (#/hr)		10			10			10			10	
Act Effct Green (s)	24.8	23.5		23.2		29.6	93.2	86.9		102.6	93.5	107.1
Actuated g/C Ratio	0.18	0.17		0.17		0.21	0.67	0.62		0.73	0.67	0.76
v/c Ratio	0.56	0.46		0.04		0.43	0.37	0.51		0.43	0.96	0.05
Control Delay	55.5	8.2		32.8		23.2	33.1	18.5		14.1	38.0	4.1
Queue Delay	0.0	0.0		0.0		0.0	0.0	0.0		0.0	0.0	0.0
Total Delay	55.5	8.2		32.8		23.2	33.1	18.5		14.1	38.0	4.1
LOS	E	A		C		C	C	B		B	D	A
Approach Delay		26.9						19.1			35.6	
Approach LOS		C						B			D	
90th %ile Green (s)	6.5	43.0		6.5	43.0	10.9	6.0	57.1		10.9	62.0	6.5
90th %ile Term Code	Max	Ped		Max	Ped	Max	Max	Coord		Max	Coord	Max
70th %ile Green (s)	6.5	55.0		0.0	43.0	10.9	6.0	57.1		10.9	62.0	6.5
70th %ile Term Code	Max	Hold		Skip	Ped	Max	Max	Coord		Max	Coord	Max
50th %ile Green (s)	6.5	6.5		0.0	0.0	13.1	5.9	103.4		13.1	110.6	6.5
50th %ile Term Code	Max	Hold		Skip	Skip	Gap	Gap	Coord		Gap	Coord	Max
30th %ile Green (s)	6.5	6.5		0.0	0.0	9.8	5.7	106.7		9.8	110.8	6.5
30th %ile Term Code	Max	Hold		Skip	Skip	Gap	Gap	Coord		Gap	Coord	Max
10th %ile Green (s)	6.5	6.5		0.0	0.0	6.4	0.0	110.1		6.4	122.0	6.5
10th %ile Term Code	Max	Hold		Skip	Skip	Gap	Skip	Coord		Gap	Coord	Max
Stops (vph)	95	19		7		68	32	473		50	1146	7
Fuel Used(gal)	3	2		0		2	1	16		3	59	1
CO Emissions (g/hr)	190	111		10		156	64	1085		207	4152	71
NOx Emissions (g/hr)	37	22		2		30	13	211		40	808	14
VOC Emissions (g/hr)	44	26		2		36	15	252		48	962	17
Dilemma Vehicles (#)	0	0		0		0	0	50		0	68	0
Queue Length 50th (ft)	~162	2		7		81	4	292		13	533	0
Queue Length 95th (ft)	139	83		18		121	m64	m367		123	#1858	31
Internal Link Dist (ft)		682			693			825			1924	
Turn Bay Length (ft)							210			480		93
Base Capacity (vph)	225	643		200		411	130	2174		363	2362	1225



Lanes, Volumes, Timings  
 6: Carothers/Carothers Parkway & Apartments/Resource

11/18/2016



Lane Group	EBL	EBT	EBR	WBL	WBT	WBR	NBL	NBT	NBR	SBL	SBT	SBR
Starvation Cap Reductn	0	0		0		0	0	0		0	0	0
Spillback Cap Reductn	0	0		0		0	0	0		0	0	0
Storage Cap Reductn	0	0		0		0	0	0		0	0	0
Reduced v/c Ratio	0.56	0.30		0.04		0.42	0.36	0.51		0.41	0.96	0.05

Intersection Summary

Area Type:	Other
Cycle Length:	140
Actuated Cycle Length:	140
Offset:	136 (97%), Referenced to phase 2:SBTL and 6:NBTL, Start of Yellow
Natural Cycle:	120
Control Type:	Actuated-Coordinated
Maximum v/c Ratio:	0.96
Intersection Signal Delay:	29.8
Intersection LOS:	C
Intersection Capacity Utilization	94.4%
ICU Level of Service	F
Analysis Period (min)	60
~	Volume exceeds capacity, queue is theoretically infinite. Queue shown is maximum after two cycles.
#	95th percentile volume exceeds capacity, queue may be longer. Queue shown is maximum after two cycles.
m	Volume for 95th percentile queue is metered by upstream signal.

Splits and Phases: 6: Carothers/Carothers Parkway & Apartments/Resource

Ø1	Ø2 (R)	Ø3	Ø4
11.5 s	68 s	12 s	48.5 s
Ø5	Ø6 (R)	Ø7	Ø8
16.4 s	63.1 s	12 s	48.5 s

# HCS 2010 Two-Way Stop Control Summary Report

General Information		Site Information	
Analyst	FTG	Intersection	Resource and Pacific
Agency/Co.	FTG	Jurisdiction	Franklin, TN
Date Performed	Nov	East/West Street	Pacific Drive
Analysis Year	2016	North/South Street	Resource Drive
Time Analyzed	AM Peak Hour	Peak Hour Factor	0.92
Intersection Orientation	North-South	Analysis Time Period (hrs)	0.25
Project Description	10765 (Total)		

## Lanes

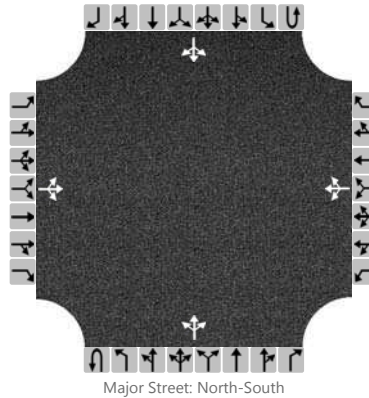

## Vehicle Volumes and Adjustments

Approach	Eastbound				Westbound				Northbound				Southbound				
	U	L	T	R	U	L	T	R	U	L	T	R	U	L	T	R	
Movement																	
Priority		10	11	12		7	8	9	1U	1	2	3	4U	4	5	6	
Number of Lanes		0	1	0		0	1	0	0	0	1	0	0	0	1	0	
Configuration			LTR				LTR				LTR				LTR		
Volume (veh/h)		19	4	162		5	11	10		192	74	0		1	115	38	
Percent Heavy Vehicles		0	0	0		0	0	0		0				0			
Proportion Time Blocked																	
Right Turn Channelized	No				No				No				No				
Median Type	Undivided																
Median Storage																	

## Delay, Queue Length, and Level of Service

Flow Rate (veh/h)			201				28					209				1		
Capacity			741				404					1425				1531		
v/c Ratio			0.27				0.07					0.15				0.00		
95% Queue Length			1.1				0.2					0.5				0.0		
Control Delay (s/veh)			11.7				14.6					8.0				7.4		
Level of Service (LOS)			B				B					A				A		
Approach Delay (s/veh)	11.7				14.6				6.1				0.0					
Approach LOS	B				B				A				A					

# HCS 2010 Two-Way Stop Control Summary Report

General Information		Site Information	
Analyst	FTG	Intersection	Resource and Pacific
Agency/Co.	FTG	Jurisdiction	Franklin, TN
Date Performed	Nov	East/West Street	Pacific Drive
Analysis Year	2016	North/South Street	Resource Drive
Time Analyzed	PM Peak Hour	Peak Hour Factor	0.92
Intersection Orientation	North-South	Analysis Time Period (hrs)	0.25
Project Description	10765 (Total)		

## Lanes

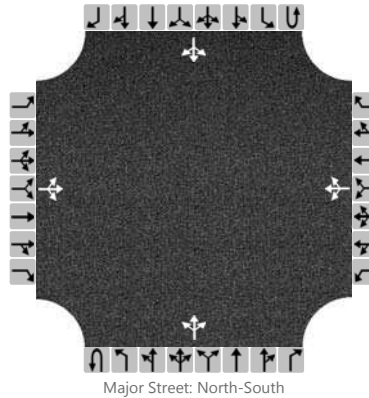

## Vehicle Volumes and Adjustments

Approach	Eastbound				Westbound				Northbound				Southbound			
	U	L	T	R	U	L	T	R	U	L	T	R	U	L	T	R
Movement																
Priority		10	11	12		7	8	9	1U	1	2	3	4U	4	5	6
Number of Lanes		0	1	0		0	1	0	0	0	1	0	0	0	1	0
Configuration			LTR				LTR				LTR				LTR	
Volume (veh/h)		26	4	190		6	4	1		125	140	1		12	99	19
Percent Heavy Vehicles		0	0	0		0	0	0		0				0		
Proportion Time Blocked																
Right Turn Channelized	No				No				No				No			
Median Type	Undivided															
Median Storage																

## Delay, Queue Length, and Level of Service

Flow Rate (veh/h)			239				12					136				13		
Capacity			792				314					1469				1440		
v/c Ratio			0.30				0.04					0.09				0.01		
95% Queue Length			1.3				0.1					0.3				0.0		
Control Delay (s/veh)			11.5				16.9					7.7				7.5		
Level of Service (LOS)			B				C					A				A		
Approach Delay (s/veh)	11.5				16.9				4.0				0.8					
Approach LOS	B				C				A				A					

# HCS 2010 Two-Way Stop Control Summary Report

General Information		Site Information	
Analyst	FTG	Intersection	Resource and Terrapin
Agency/Co.	FTG	Jurisdiction	Franklin, TN
Date Performed	Nov	East/West Street	Terrapin St
Analysis Year	2016	North/South Street	Resource Drive
Time Analyzed	AM Peak Hour	Peak Hour Factor	0.92
Intersection Orientation	North-South	Analysis Time Period (hrs)	0.25
Project Description	10765 (Total)		

## Lanes

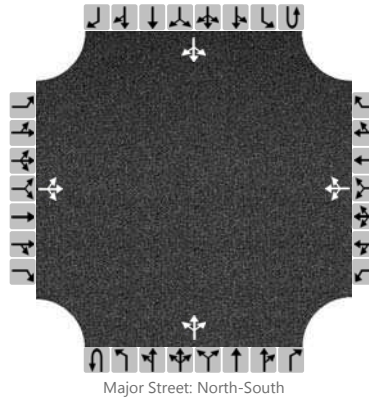

## Vehicle Volumes and Adjustments

Approach	Eastbound				Westbound				Northbound				Southbound			
	U	L	T	R	U	L	T	R	U	L	T	R	U	L	T	R
Movement																
Priority		10	11	12		7	8	9	1U	1	2	3	4U	4	5	6
Number of Lanes		0	1	0		0	1	0	0	0	1	0	0	0	1	0
Configuration			LTR				LTR				LTR				LTR	
Volume (veh/h)		7	0	10		9	0	20		16	295	2		2	294	11
Percent Heavy Vehicles		0	0	0		0	0	0		0				0		
Proportion Time Blocked																
Right Turn Channelized	No				No				No				No			
Median Type	Undivided															
Median Storage																

## Delay, Queue Length, and Level of Service

Flow Rate (veh/h)			19				32					17				2	
Capacity			492				543					1239				1248	
v/c Ratio			0.04				0.06					0.01				0.00	
95% Queue Length			0.1				0.2					0.0				0.0	
Control Delay (s/veh)			12.6				12.0					7.9				7.9	
Level of Service (LOS)			B				B					A				A	
Approach Delay (s/veh)	12.6				12.0				0.5				0.1				
Approach LOS	B				B				A				A				

# HCS 2010 Two-Way Stop Control Summary Report

General Information		Site Information	
Analyst	FTG	Intersection	Resource and Terrapin
Agency/Co.	FTG	Jurisdiction	Franklin, TN
Date Performed	Nov	East/West Street	Terrapin St
Analysis Year	2016	North/South Street	Resource Drive
Time Analyzed	PM Peak Hour	Peak Hour Factor	0.92
Intersection Orientation	North-South	Analysis Time Period (hrs)	0.25
Project Description	10765 (Total)		

## Lanes

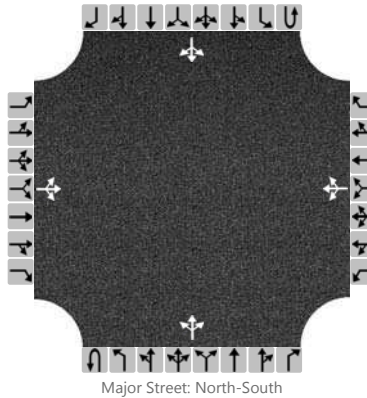

## Vehicle Volumes and Adjustments

Approach	Eastbound				Westbound				Northbound				Southbound			
	U	L	T	R	U	L	T	R	U	L	T	R	U	L	T	R
Movement																
Priority		10	11	12		7	8	9	1U	1	2	3	4U	4	5	6
Number of Lanes		0	1	0		0	1	0	0	0	1	0	0	0	1	0
Configuration			LTR				LTR				LTR				LTR	
Volume (veh/h)		9	0	14		7	0	6		8	270	6		13	322	7
Percent Heavy Vehicles		0	0	0		0	0	0		0				0		
Proportion Time Blocked																
Right Turn Channelized	No				No				No				No			
Median Type	Undivided															
Median Storage																

## Delay, Queue Length, and Level of Service

Flow Rate (veh/h)			25				15			9					14		
Capacity			496				457			1212					1273		
v/c Ratio			0.05				0.03			0.01					0.01		
95% Queue Length			0.2				0.1			0.0					0.0		
Control Delay (s/veh)			12.6				13.1			8.0					7.9		
Level of Service (LOS)			B				B			A					A		
Approach Delay (s/veh)	12.6				13.1				0.3				0.4				
Approach LOS	B				B				A				A				

Phone:  
E-Mail:

Fax:

-----ROUNDBOUT ANALYSIS-----

Analyst: FTG  
 Agency/Co.: FTG  
 Date Performed: Nov 2016  
 Analysis Time Period: AM Peak Hour  
 Intersection: Resource and Lemon Grass  
 Jurisdiction: Franklin, TN  
 Units: U. S. Customary  
 Analysis Year: 2016 (Total)  
 Project ID: 10765  
 East/West Street: Resource Drive  
 North/South Street: Lemon Grass Drive

-----Volume Adjustments and Site Characteristics-----

	Eastbound			Westbound			Northbound			Southbound		
	L	T	R	L	T	R	L	T	R	L	T	R
Volume	0	276	37	45	250	148	52	0	0	22	0	11
U-Turn Vol	0			0			0			0		
% Thrus Left Lane	Eastbound			Westbound			Northbound			Southbound		
	Left Right BP			Left Right BP			Left Right BP			Left Right BP		
Lane Assn.	LTR			LTR			LTR			LTR		
RT Bypass	None			None			None			None		
PHF	0.92	0.92	0.92	0.92	0.92	0.92	0.92	0.92	0.92	0.92	0.92	0.92
%HV	0	0	0	0	0	0	0	0	0	0	0	0
NumPeds	0			0			0			0		
U-Turn PHF	0.92			0.92			0.92			0.92		
U-Turn %HV	3			3			3			3		
Flow Rate	0	300	40	49	272	161	57	0	0	24	0	12
No. Lanes	0	1	0	0	1	0	0	1	0	0	1	0
Cnfl. Lanes	1			1			1			1		
Duration, T	0.25 hrs.											

-----Critical and Follow-Up Headway Adjustment-----

Crit. Hdwy	5.1929	Eastbound			Westbound			Northbound			Southbound		
		5.1929	5.1929	5.1929	5.1929	5.1929	5.1929	5.1929	5.1929	5.1929	5.1929	5.1929	
Crit. Hdwy	5.1929	Northbound			Southbound			Northbound			Southbound		
		5.1929	5.1929	5.1929	5.1929	5.1929	5.1929	5.1929	5.1929	5.1929	5.1929	5.1929	
Flup. Hdwy	3.1858	Eastbound			Westbound			Northbound			Southbound		
		3.1858	3.1858	3.1858	3.1858	3.1858	3.1858	3.1858	3.1858	3.1858	3.1858	3.1858	
Flup. Hdwy	3.1858	Northbound			Southbound			Northbound			Southbound		
		3.1858	3.1858	3.1858	3.1858	3.1858	3.1858	3.1858	3.1858	3.1858	3.1858	3.1858	

-----Flow Computations-----

	Eastbound	Westbound	Northbound	Southbound
Circ. Flow	73	57	324	378
Exit. Flow	324	340	161	89

-----Capacity and Level of Service-----

Eastbound                      Westbound                      Northbound                      Southbound

	Left	Right	BP	Left	Right	BP	Left	Right	BP	Left	Right	BP
Entry Flow		340			482			57			36	
Entry Cap.		1051			1068			817			775	
Volume (vph)		340			482			57			36	
Cap. (vph)		1051			1068			817			775	
v/c Ratio		0.32			0.45			0.07			0.05	
Critical Lane		*			*			*			*	
Lane Delay		6.7			8.4			5.1			5.1	
Lane LOS		A			A			A			A	
95 % Queue		1.4			2.4			0.2			0.1	
Approach:												
Delay		6.67			8.37			5.09			5.10	
LOS		A			A			A			A	
Intersection Delay		7.41					Intersection	LOS			A	

---

Phone:  
E-Mail:

Fax:

-----                    ROUNDBOUT ANALYSIS                    -----

Analyst: FTG  
 Agency/Co.: FTG  
 Date Performed: Nov 2016  
 Analysis Time Period: PM Peak Hour  
 Intersection: Resource and Lemon Grass  
 Jurisdiction: Franklin, TN  
 Units: U. S. Customary  
 Analysis Year: 2016 (Total)  
 Project ID: 10765  
 East/West Street: Resource Drive  
 North/South Street: Lemon Grass Drive

-----                    Volume Adjustments and Site Characteristics                    -----

	Eastbound			Westbound			Northbound			Southbound		
	L	T	R	L	T	R	L	T	R	L	T	R
Volume	13	303	27	14	229	34	45	0	23	149	0	10
U-Turn Vol	0			0			0			0		
% Thrus Left Lane	Eastbound			Westbound			Northbound			Southbound		
	Left Right BP			Left Right BP			Left Right BP			Left Right BP		
Lane Assn.	LTR			LTR			LTR			LTR		
RT Bypass	None			None			None			None		
PHF	0.92	0.92	0.92	0.92	0.92	0.92	0.92	0.92	0.92	0.92	0.92	0.92
%HV	0	0	0	0	0	0	0	0	0	0	0	0
NumPeds	0			0			0			0		
U-Turn PHF	0.92			0.92			0.92			0.92		
U-Turn %HV	3			3			3			3		
Flow Rate	14	329	29	15	249	37	49	0	25	162	0	11
No. Lanes	0	1	0	0	1	0	0	1	0	0	1	0
Cnfl. Lanes	1			1			1			1		
Duration, T	0.25 hrs.											

-----                    Critical and Follow-Up Headway Adjustment                    -----

Crit. Hdwy	5.1929	Eastbound			Westbound			Northbound			Southbound		
		5.1929	5.1929	5.1929	5.1929	5.1929	5.1929	5.1929	5.1929	5.1929	5.1929	5.1929	
Crit. Hdwy	5.1929	Northbound			Southbound			Northbound			Southbound		
		5.1929	5.1929	5.1929	5.1929	5.1929	5.1929	5.1929	5.1929	5.1929	5.1929	5.1929	
Flup. Hdwy	3.1858	Eastbound			Westbound			Northbound			Southbound		
		3.1858	3.1858	3.1858	3.1858	3.1858	3.1858	3.1858	3.1858	3.1858	3.1858	3.1858	
Flup. Hdwy	3.1858	Northbound			Southbound			Northbound			Southbound		
		3.1858	3.1858	3.1858	3.1858	3.1858	3.1858	3.1858	3.1858	3.1858	3.1858	3.1858	

-----                    Flow Computations                    -----

	Eastbound	Westbound	Northbound	Southbound
Circ. Flow	177	63	505	313
Exit. Flow	516	309	51	45

-----                    Capacity and Level of Service                    -----

Eastbound                      Westbound                      Northbound                      Southbound



	Left	Right	BP	Left	Right	BP	Left	Right	BP	Left	Right	BP
Entry Flow		373			301			74			173	
Entry Cap.		947			1061			682			826	
Volume (vph)		373			301			74			173	
Cap. (vph)		947			1061			682			826	
v/c Ratio		0.39			0.28			0.11			0.21	
Critical Lane		*			*			*			*	
Lane Delay		8.2			6.1			6.5			6.6	
Lane LOS		A			A			A			A	
95 % Queue		1.9			1.2			0.4			0.8	
Approach:												
Delay		8.22			6.15			6.46			6.56	
LOS		A			A			A			A	
Intersection Delay		7.09						Intersection LOS			A	

---

# HCS 2010 Two-Way Stop Control Summary Report

General Information				Site Information			
Analyst	FTG			Intersection	Pacific and W. Project		
Agency/Co.	FTG			Jurisdiction	Franklin, TN		
Date Performed	Nov 2016			East/West Street	Pacific Drive		
Analysis Year	2016			North/South Street	Western Project Drive		
Time Analyzed	AM Peak Hour			Peak Hour Factor	0.80		
Intersection Orientation	East-West			Analysis Time Period (hrs)	0.25		
Project Description	10765						

## Lanes

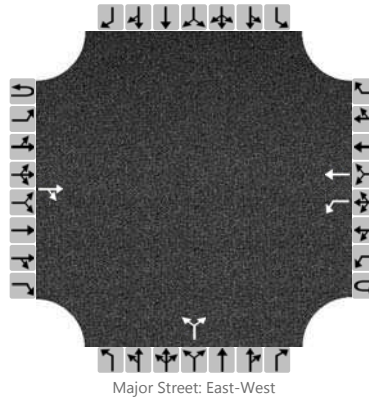

## Vehicle Volumes and Adjustments

Approach	Eastbound				Westbound				Northbound				Southbound			
	U	L	T	R	U	L	T	R	U	L	T	R	U	L	T	R
Movement	1U	1	2	3	4U	4	5	6		7	8	9		10	11	12
Priority																
Number of Lanes	0	0	1	0	0	1	1	0		0	0	0		0	0	0
Configuration				TR		L	T				LR					
Volume (veh/h)			228	27		0	164			17		0				
Percent Heavy Vehicles						0				0		0				
Proportion Time Blocked																
Right Turn Channelized	No				No				No				No			
Median Type	Undivided															
Median Storage																

## Delay, Queue Length, and Level of Service

Flow Rate (veh/h)											21					
Capacity						1253					529					
v/c Ratio											0.04					
95% Queue Length											0.1					
Control Delay (s/veh)						7.9					12.1					
Level of Service (LOS)						A					B					
Approach Delay (s/veh)									12.1							
Approach LOS									B							

# HCS 2010 Two-Way Stop Control Summary Report

General Information		Site Information	
Analyst	FTG	Intersection	Pacific and W. Project
Agency/Co.	FTG	Jurisdiction	Franklin, TN
Date Performed	Nov 2016	East/West Street	Pacific Drive
Analysis Year	2016	North/South Street	Western Project Drive
Time Analyzed	PM Peak Hour	Peak Hour Factor	0.80
Intersection Orientation	East-West	Analysis Time Period (hrs)	0.25
Project Description	10765		

## Lanes

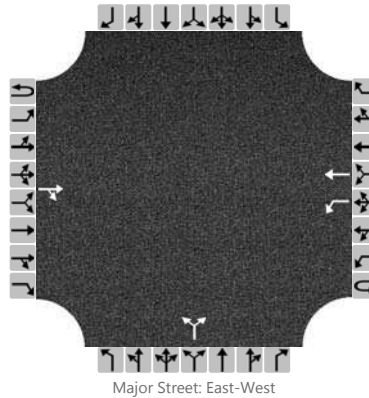

## Vehicle Volumes and Adjustments

Approach	Eastbound				Westbound				Northbound				Southbound			
	U	L	T	R	U	L	T	R	U	L	T	R	U	L	T	R
Movement	1U	1	2	3	4U	4	5	6		7	8	9		10	11	12
Priority																
Number of Lanes	0	0	1	0	0	1	1	0		0	0	0		0	0	0
Configuration				TR		L	T				LR					
Volume (veh/h)			143	13		0	176			23		0				
Percent Heavy Vehicles						0				0		0				
Proportion Time Blocked																
Right Turn Channelized	No				No				No				No			
Median Type	Undivided															
Median Storage																

## Delay, Queue Length, and Level of Service

Flow Rate (veh/h)											29					
Capacity						1390					604					
v/c Ratio											0.05					
95% Queue Length											0.2					
Control Delay (s/veh)						7.6					11.3					
Level of Service (LOS)						A					B					
Approach Delay (s/veh)									11.3							
Approach LOS									B							

# HCS 2010 Two-Way Stop Control Summary Report

General Information		Site Information	
Analyst	FTG	Intersection	Pacific and Garage
Agency/Co.	FTG	Jurisdiction	Franklin, TN
Date Performed	Nov 2016	East/West Street	Pacific Drive
Analysis Year	2016	North/South Street	Garage Access
Time Analyzed	AM Peak Hour	Peak Hour Factor	0.80
Intersection Orientation	East-West	Analysis Time Period (hrs)	0.25
Project Description	10765		

## Lanes

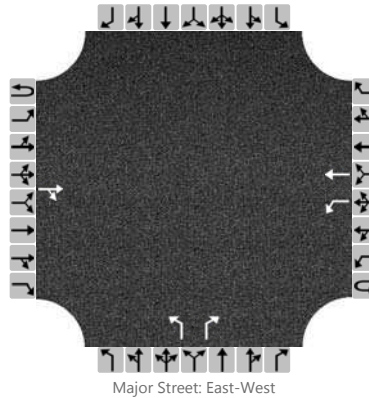

## Vehicle Volumes and Adjustments

Approach	Eastbound				Westbound				Northbound				Southbound			
	U	L	T	R	U	L	T	R	U	L	T	R	U	L	T	R
Movement	1U	1	2	3	4U	4	5	6		7	8	9		10	11	12
Number of Lanes	0	0	1	0	0	1	1	0		1	0	1		0	0	0
Configuration				TR		L	T			L		R				
Volume (veh/h)			64	164		163	78			86		121				
Percent Heavy Vehicles						0				0		0				
Proportion Time Blocked																
Right Turn Channelized	No				No				No				No			
Median Type	Undivided															
Median Storage																

## Delay, Queue Length, and Level of Service

Flow Rate (veh/h)					204					108		151				
Capacity					1289					350		866				
v/c Ratio					0.16					0.31		0.17				
95% Queue Length					0.6					1.3		0.6				
Control Delay (s/veh)					8.3					19.8		10.0				
Level of Service (LOS)					A					C		B				
Approach Delay (s/veh)					5.6				14.1							
Approach LOS					A				B							

# HCS 2010 Two-Way Stop Control Summary Report

General Information				Site Information			
Analyst	FTG			Intersection	Pacific and Garage		
Agency/Co.	FTG			Jurisdiction	Franklin, TN		
Date Performed	Nov 2016			East/West Street	Pacific Drive		
Analysis Year	2016			North/South Street	Garage Access		
Time Analyzed	PM Peak Hour			Peak Hour Factor	0.80		
Intersection Orientation	East-West			Analysis Time Period (hrs)	0.25		
Project Description	10765						

## Lanes

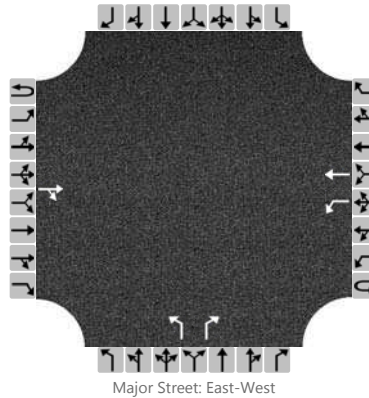

## Vehicle Volumes and Adjustments

Approach	Eastbound				Westbound				Northbound				Southbound			
	U	L	T	R	U	L	T	R	U	L	T	R	U	L	T	R
Movement	1U	1	2	3	4U	4	5	6		7	8	9		10	11	12
Priority																
Number of Lanes	0	0	1	0	0	1	1	0		1	0	1		0	0	0
Configuration				TR		L	T			L		R				
Volume (veh/h)			61	82		84	64			112		159				
Percent Heavy Vehicles						0				0		0				
Proportion Time Blocked																
Right Turn Channelized	No				No				No				No			
Median Type	Undivided															
Median Storage																

## Delay, Queue Length, and Level of Service

Flow Rate (veh/h)					105					140		199				
Capacity					1410					552		929				
v/c Ratio					0.07					0.25		0.21				
95% Queue Length					0.2					1.0		0.8				
Control Delay (s/veh)					7.8					13.7		9.9				
Level of Service (LOS)					A					B		A				
Approach Delay (s/veh)					4.4				11.5							
Approach LOS					A				B							

# HCS 2010 Two-Way Stop Control Summary Report

General Information		Site Information	
Analyst	FTG	Intersection	Resource and Project Dwy
Agency/Co.	FTG	Jurisdiction	Franklin, TN
Date Performed	Nov	East/West Street	Project Driveway
Analysis Year	2016	North/South Street	Resource Drive
Time Analyzed	AM Peak Hour	Peak Hour Factor	0.92
Intersection Orientation	North-South	Analysis Time Period (hrs)	0.25
Project Description	10765 (Total)		

## Lanes

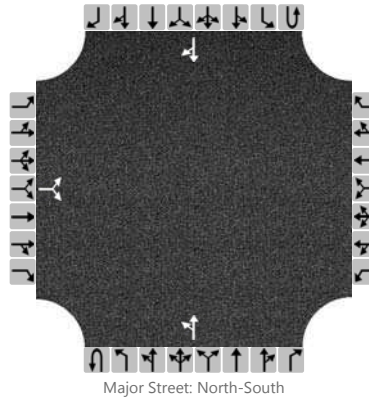

## Vehicle Volumes and Adjustments

Approach	Eastbound				Westbound				Northbound				Southbound			
	U	L	T	R	U	L	T	R	U	L	T	R	U	L	T	R
Movement																
Priority		10	11	12		7	8	9	1U	1	2	3	4U	4	5	6
Number of Lanes		0	0	0		0	0	0	0	0	1	0	0	0	1	0
Configuration			LR							LT						TR
Volume (veh/h)		10		41						66	256				266	16
Percent Heavy Vehicles		0		0						0						
Proportion Time Blocked																
Right Turn Channelized	No				No				No				No			
Median Type	Undivided															
Median Storage																

## Delay, Queue Length, and Level of Service

Flow Rate (veh/h)			56							350						
Capacity			597							1266						
v/c Ratio			0.09							0.28						
95% Queue Length			0.3							0.2						
Control Delay (s/veh)			11.7							8.0						
Level of Service (LOS)			B							A						
Approach Delay (s/veh)	11.7								2.1							
Approach LOS	B								A							

# HCS 2010 Two-Way Stop Control Summary Report

General Information		Site Information	
Analyst	FTG	Intersection	Resource and Project Dwy
Agency/Co.	FTG	Jurisdiction	Franklin, TN
Date Performed	Nov	East/West Street	Project Driveway
Analysis Year	2016	North/South Street	Resource Drive
Time Analyzed	PM Peak Hour	Peak Hour Factor	0.92
Intersection Orientation	North-South	Analysis Time Period (hrs)	0.25
Project Description	10765 (Total)		

## Lanes

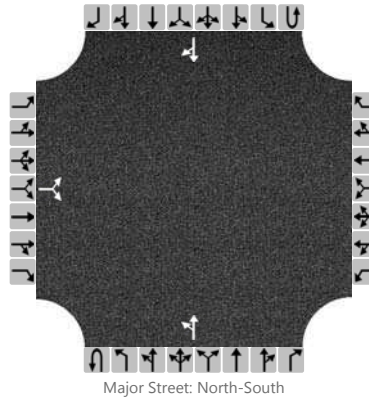

## Vehicle Volumes and Adjustments

Approach	Eastbound				Westbound				Northbound				Southbound				
	U	L	T	R	U	L	T	R	U	L	T	R	U	L	T	R	
Movement																	
Priority		10	11	12		7	8	9	1U	1	2	3	4U	4	5	6	
Number of Lanes		0	0	0		0	0	0	0	0	1	0	0	0	1	0	
Configuration			LR							LT							TR
Volume (veh/h)		14		55						33	252					287	8
Percent Heavy Vehicles		0		0						0							
Proportion Time Blocked																	
Right Turn Channelized	No				No				No				No				
Median Type	Undivided																
Median Storage																	

## Delay, Queue Length, and Level of Service

Flow Rate (veh/h)			75										310				
Capacity			610										1250				
v/c Ratio			0.12										0.25				
95% Queue Length			0.4										0.1				
Control Delay (s/veh)			11.7										8.0				
Level of Service (LOS)			B										A				
Approach Delay (s/veh)	11.7								1.2								
Approach LOS	B								A								

**APPENDIX D  
TRIP GENERATION**



**TRIP GENERATION CALCULATIONS – Multi-Family**

The following calculations are based on the data compiled for ITE Land Use Code 220.

**Average Daily Traffic**

$$T = 6.65 (X)$$

$$T = 6.65 (325)$$

$$T = 2,162 \text{ vehicle-trips}$$

$$\text{Enter} = 0.50 (2,162) = 1,081 \text{ vehicles}$$

$$\text{Exit} = 0.50 (2,162) = 1,081 \text{ vehicles}$$

**A.M. traffic during peak hour of adjacent street**

$$T = 0.51 (X)$$

$$T = 0.51 (325)$$

$$T = 166 \text{ vehicle-trips}$$

$$\text{Enter} = 0.20 (166) = 33 \text{ vehicles}$$

$$\text{Exit} = 0.80 (166) = 133 \text{ vehicles}$$

**P.M. traffic during peak hour of adjacent street**

$$T = 0.62 (X)$$

$$T = 0.62 (325)$$

$$T = 202 \text{ vehicle-trips}$$

$$\text{Enter} = 0.65 (202) = 131 \text{ vehicles}$$

$$\text{Exit} = 0.35 (202) = 71 \text{ vehicles}$$

**TRIP GENERATION - Townhomes**

The following calculations are based on the data compiled for ITE Land Use Code 230.

**Average Daily Traffic**

$$\ln(T) = 0.87 \ln(X) + 2.46$$

$$\ln(T) = 0.87 \ln(15) + 2.46$$

$$T = 124 \text{ vehicles}$$

$$\text{Enter} = 0.50 (124) = 62 \text{ vehicles}$$

$$\text{Exit} = 0.50 (124) = 62 \text{ vehicles}$$

**AM traffic during peak hour of adjacent street**

$$\ln(T) = 0.80 \ln(X) + 0.26$$

$$\ln(T) = 0.80 \ln(15) + 0.26$$

$$T = 11 \text{ vehicles}$$

$$\text{Enter} = 0.17 (11) = 2 \text{ vehicles}$$

$$\text{Exit} = 0.83 (11) = 9 \text{ vehicles}$$

**PM traffic during peak hour of adjacent street**

$$\ln(T) = 0.82 \ln(X) + 0.32$$

$$\ln(T) = 0.82 \ln(15) + 0.32$$

$$T = 13 \text{ vehicles}$$

$$\text{Enter} = 0.67 (13) = 9 \text{ vehicles}$$

$$\text{Exit} = 0.33 (13) = 4 \text{ vehicles}$$

**TRIP GENERATION CALCULATIONS – Office**

The following calculations are based on the data compiled for ITE Land Use Code 710.

**Average Daily Traffic**

$$\ln(T) = 0.76 \ln(X) + 3.68$$

$$\ln(T) = 0.76 \ln(300.000) + 3.68$$

$$T = 3,026 \text{ vehicle-trips}$$

$$\text{Enter} = 0.50 (3,026) = 1,513 \text{ vehicles}$$

$$\text{Exit} = 0.50 (3,026) = 1,513 \text{ vehicles}$$

**A.M. traffic during peak hour of adjacent street**

$$\ln(T) = 0.80 \ln(X) + 1.57$$

$$\ln(T) = 0.80 \ln(300.000) + 1.57$$

$$T = 461 \text{ vehicle-trips}$$

$$\text{Enter} = 0.88 (461) = 405 \text{ vehicles}$$

$$\text{Exit} = 0.12 (461) = 55 \text{ vehicles}$$

**P.M. traffic during peak hour of adjacent street**

$$T = 1.12 (X) + 78.45$$

$$T = 1.12 (300.000) + 78.45$$

$$T = 414 \text{ vehicle-trips}$$

$$\text{Enter} = 0.17 (414) = 70 \text{ vehicles}$$

$$\text{Exit} = 0.83 (414) = 344 \text{ vehicles}$$

**TRIP GENERATION CALCULATIONS – Hotel**

The following calculations are based on the data compiled for ITE Land Use Code 310.

**Average Daily Traffic**

$$T = 8.92 \text{ (X)}$$

$$T = 8.92 \text{ (200)}$$

$$T = 1,784 \text{ vehicle-trips}$$

$$\text{Enter} = 0.50 (1,784) = 892 \text{ vehicles}$$

$$\text{Exit} = 0.50 (1,784) = 892 \text{ vehicles}$$

**AM traffic during peak hour of adjacent street**

$$T = 0.67 \text{ (X)}$$

$$T = 0.67 \text{ (200)}$$

$$T = 134 \text{ vehicle-trips}$$

$$\text{Enter} = 0.58 (134) = 78 \text{ vehicles}$$

$$\text{Exit} = 0.42 (134) = 56 \text{ vehicles}$$

**PM traffic during peak hour of adjacent street**

$$T = 0.70 \text{ (X)}$$

$$T = 0.70 \text{ (200)}$$

$$T = 140 \text{ vehicle-trips}$$

$$\text{Enter} = 0.49 (140) = 69 \text{ vehicles}$$

$$\text{Exit} = 0.51 (140) = 71 \text{ vehicles}$$

**TRIP GENERATION CALCULATIONS – Specialty Retail**

The following calculations are based on the data compiled for ITE Land Use Code 826.

**Average Daily Traffic**

$$T = 42.78 (X) + 37.66$$

$$T = 42.78 (50.000) + 37.66$$

$$T = 2,176 \text{ vehicle-trips}$$

$$\text{Enter} = 0.50 (2,176) = 1,088 \text{ vehicles}$$

$$\text{Exit} = 0.50 (2,176) = 1,088 \text{ vehicles}$$

**A.M. traffic during peak hour of adjacent street**

$$T = 6.84 (X)$$

$$T = 6.84 (50.000)$$

$$T = 342 \text{ vehicle-trips}$$

$$\text{Enter} = 0.48 (342) = 164 \text{ vehicles}$$

$$\text{Exit} = 0.52 (342) = 178 \text{ vehicles}$$

**P.M. traffic during peak hour of adjacent street**

$$T = 2.40 (X) + 21.48$$

$$T = 2.40 (50.000) + 21.48$$

$$T = 141 \text{ vehicle-trips}$$

$$\text{Enter} = 0.44 (141) = 62 \text{ vehicles}$$

$$\text{Exit} = 0.56 (141) = 79 \text{ vehicles}$$

NCHRP 684 Internal Trip Capture Estimation Tool					
Project Name:	Crescent Resource Centre			Organization:	FTG
Project Location:	E. McEwen Drive and Carothers Parkway			Performed By:	FTG
Scenario Description:				Date:	19-Sep
Analysis Year:				Checked By:	
Analysis Period:	AM Street Peak Hour			Date:	

Table 1-A: Base Vehicle-Trip Generation Estimates (Single-Use Site Estimate)						
Land Use	Development Data (For Information Only)			Estimated Vehicle-Trips <sup>3</sup>		
	ITE LUCs <sup>1</sup>	Quantity	Units	Total	Entering	Exiting
Office	710	283,000		440	387	53
Retail	826	16,500		113	54	59
Restaurant		19,500		428	224	204
Cinema/Entertainment				0		
Residential			340	177	35	142
Hotel			180	121	70	51
All Other Land Uses <sup>2</sup>				0		
				1,279	770	509

Table 2-A: Mode Split and Vehicle Occupancy Estimates						
Land Use	Entering Trips			Exiting Trips		
	Veh. Occ. <sup>4</sup>	% Transit	% Non-Motorized	Veh. Occ. <sup>4</sup>	% Transit	% Non-Motorized
Office	1.10	2%	0%	1.10	2%	0%
Retail	1.50	2%	0%	1.50	2%	0%
Restaurant	2.00	2%	0%	2.00	2%	0%
Cinema/Entertainment						
Residential	1.10	2%	0%	1.10	2%	0%
Hotel	1.10	2%	0%	1.10	2%	0%
All Other Land Uses <sup>2</sup>						

Table 3-A: Average Land Use Interchange Distances (Feet Walking Distance)						
Origin (From)	Destination (To)					
	Office	Retail	Restaurant	Cinema/Entertainment	Residential	Hotel
Office						
Retail						
Restaurant						
Cinema/Entertainment						
Residential						
Hotel						

Table 4-A: Internal Person-Trip Origin-Destination Matrix*						
Origin (From)	Destination (To)					
	Office	Retail	Restaurant	Cinema/Entertainment	Residential	Hotel
Office		16	37	0	0	0
Retail	17		12	0	1	0
Restaurant	60	6		0	2	3
Cinema/Entertainment	0	0	0		0	0
Residential	3	2	31	0		0
Hotel	13	3	5	0	0	

Table 5-A: Computations Summary			
	Total	Entering	Exiting
All Person-Trips	1,838	1,071	767
Internal Capture Percentage	23%	20%	28%
External Vehicle-Trips <sup>5</sup>	954	607	347
External Transit-Trips <sup>6</sup>	28	17	11
External Non-Motorized Trips <sup>6</sup>	0	0	0

Table 6-A: Internal Trip Capture Percentages by Land Use		
Land Use	Entering Trips	Exiting Trips
Office	22%	91%
Retail	33%	34%
Restaurant	19%	17%
Cinema/Entertainment	N/A	N/A
Residential	8%	23%
Hotel	4%	38%

<sup>1</sup>Land Use Codes (LUCs) from *Trip Generation Manual*, published by the Institute of Transportation Engineers.

<sup>2</sup>Total estimate for all other land uses at mixed-use development site is not subject to internal trip capture computations in this estimator.

<sup>3</sup>Enter trips assuming no transit or non-motorized trips (as assumed in ITE *Trip Generation Manual*).

<sup>4</sup>Enter vehicle occupancy assumed in Table 1-A vehicle trips. If vehicle occupancy changes for proposed mixed-use project, manual adjustments must be made to Tables 5-A, 9-A (O and D). Enter transit, non-motorized percentages that will result with proposed mixed-use project complete.

<sup>5</sup>Vehicle-trips computed using the mode split and vehicle occupancy values provided in Table 2-A.

<sup>6</sup>Person-Trips

\*Indicates computation that has been rounded to the nearest whole number.

<b>Project Name:</b>	Crescent Resource Centre
<b>Analysis Period:</b>	AM Street Peak Hour

Table 7-A: Conversion of Vehicle-Trip Ends to Person-Trip Ends						
Land Use	Table 7-A (D): Entering Trips			Table 7-A (O): Exiting Trips		
	Veh. Occ.	Vehicle-Trips	Person-Trips*	Veh. Occ.	Vehicle-Trips	Person-Trips*
Office	1.10	387	426	1.10	53	58
Retail	1.50	54	81	1.50	59	89
Restaurant	2.00	224	448	2.00	204	408
Cinema/Entertainment	1.00	0	0	1.00	0	0
Residential	1.10	35	39	1.10	142	156
Hotel	1.10	70	77	1.10	51	56

Table 8-A (O): Internal Person-Trip Origin-Destination Matrix (Computed at Origin)						
Origin (From)	Destination (To)					
	Office	Retail	Restaurant	Cinema/Entertainment	Residential	Hotel
Office		16	37	0	1	0
Retail	26		12	0	12	0
Restaurant	126	57		0	16	12
Cinema/Entertainment	0	0	0		0	0
Residential	3	2	31	0		0
Hotel	42	8	5	0	0	

Table 8-A (D): Internal Person-Trip Origin-Destination Matrix (Computed at Destination)						
Origin (From)	Destination (To)					
	Office	Retail	Restaurant	Cinema/Entertainment	Residential	Hotel
Office		26	103	0	0	0
Retail	17		224	0	1	0
Restaurant	60	6		0	2	3
Cinema/Entertainment	0	0	0		0	0
Residential	13	14	90	0		0
Hotel	13	3	27	0	0	

Table 9-A (D): Internal and External Trips Summary (Entering Trips)						
Destination Land Use	Person-Trip Estimates			External Trips by Mode*		
	Internal	External	Total	Vehicles <sup>1</sup>	Transit <sup>2</sup>	Non-Motorized <sup>2</sup>
Office	93	333	426	296	7	0
Retail	27	54	81	35	1	0
Restaurant	85	363	448	178	7	0
Cinema/Entertainment	0	0	0	0	0	0
Residential	3	36	39	32	1	0
Hotel	3	74	77	66	1	0
All Other Land Uses <sup>3</sup>	0	0	0	0	0	0

Table 9-A (O): Internal and External Trips Summary (Exiting Trips)						
Origin Land Use	Person-Trip Estimates			External Trips by Mode*		
	Internal	External	Total	Vehicles <sup>1</sup>	Transit <sup>2</sup>	Non-Motorized <sup>2</sup>
Office	53	5	58	5	0	0
Retail	30	59	89	39	1	0
Restaurant	71	337	408	165	7	0
Cinema/Entertainment	0	0	0	0	0	0
Residential	36	120	156	107	2	0
Hotel	21	35	56	31	1	0
All Other Land Uses <sup>3</sup>	0	0	0	0	0	0

<sup>1</sup>Vehicle-trips computed using the mode split and vehicle occupancy values provided in Table 2-A  
<sup>2</sup>Person-Trips  
<sup>3</sup>Total estimate for all other land uses at mixed-use development site is not subject to internal trip capture computations in this estimator  
\*Indicates computation that has been rounded to the nearest whole number.

NCHRP 684 Internal Trip Capture Estimation Tool			
Project Name:	Crescent Resource Centre	Organization:	FTG
Project Location:	E. McEwen Drive and Carothers Parkway	Performed By:	FTG
Scenario Description:		Date:	4-Oct
Analysis Year:		Checked By:	
Analysis Period:	PM Street Peak Hour	Date:	

Table 1-P: Base Vehicle-Trip Generation Estimates (Single-Use Site Estimate)						
Land Use	Development Data (For Information Only)			Estimated Vehicle-Trips <sup>3</sup>		
	ITE LUCs <sup>1</sup>	Quantity	Units	Total	Entering	Exiting
Office	710	283,000		395	67	328
Retail	826	16,500		61	27	34
Restaurant		19,500		336	185	151
Cinema/Entertainment				0		
Residential			340	215	140	75
Hotel			180	126	62	64
All Other Land Uses <sup>2</sup>				0		
				1,133	481	652

Table 2-P: Mode Split and Vehicle Occupancy Estimates						
Land Use	Entering Trips			Exiting Trips		
	Veh. Occ. <sup>4</sup>	% Transit	% Non-Motorized	Veh. Occ. <sup>4</sup>	% Transit	% Non-Motorized
Office						
Retail						
Restaurant						
Cinema/Entertainment						
Residential						
Hotel						
All Other Land Uses <sup>2</sup>						

Table 3-P: Average Land Use Interchange Distances (Feet Walking Distance)						
Origin (From)	Destination (To)					
	Office	Retail	Restaurant	Cinema/Entertainment	Residential	Hotel
Office						
Retail						
Restaurant						
Cinema/Entertainment						
Residential						
Hotel						

Table 4-P: Internal Person-Trip Origin-Destination Matrix*						
Origin (From)	Destination (To)					
	Office	Retail	Restaurant	Cinema/Entertainment	Residential	Hotel
Office						
Retail	1		10	0	9	2
Restaurant	5	14		0	22	11
Cinema/Entertainment	0	0	0		0	0
Residential	3	3	16	0		2
Hotel	0	1	9	0	0	

Table 5-P: Computations Summary			
	Total	Entering	Exiting
All Person-Trips	1,133	481	652
Internal Capture Percentage	21%	25%	18%
External Vehicle-Trips <sup>5</sup>	893	361	532
External Transit-Trips <sup>6</sup>	0	0	0
External Non-Motorized Trips <sup>6</sup>	0	0	0

Table 6-P: Internal Trip Capture Percentages by Land Use		
Land Use	Entering Trips	Exiting Trips
Office	13%	4%
Retail	74%	65%
Restaurant	21%	34%
Cinema/Entertainment	N/A	N/A
Residential	26%	32%
Hotel	24%	16%

<sup>1</sup>Land Use Codes (LUCs) from *Trip Generation Manual*, published by the Institute of Transportation Engineers.

<sup>2</sup>Total estimate for all other land uses at mixed-use development site is not subject to internal trip capture computations in this estimator.

<sup>3</sup>Enter trips assuming no transit or non-motorized trips (as assumed in ITE *Trip Generation Manual*).

<sup>4</sup>Enter vehicle occupancy assumed in Table 1-P vehicle trips. If vehicle occupancy changes for proposed mixed-use project, manual adjustments must be made.

<sup>5</sup>Vehicle-trips computed using the mode split and vehicle occupancy values provided in Table 2-P.

<sup>6</sup>Person-Trips

\*Indicates computation that has been rounded to the nearest whole number.

Estimation Tool Developed by the Texas A&M Transportation Institute - Version 2013.1



<b>Project Name:</b>	Crescent Resource Centre
<b>Analysis Period:</b>	PM Street Peak Hour

Table 7-P: Conversion of Vehicle-Trip Ends to Person-Trip Ends						
Land Use	Table 7-P (D): Entering Trips			Table 7-P (O): Exiting Trips		
	Veh. Occ.	Vehicle-Trips	Person-Trips*	Veh. Occ.	Vehicle-Trips	Person-Trips*
Office	1.00	67	67	1.00	328	328
Retail	1.00	27	27	1.00	34	34
Restaurant	1.00	185	185	1.00	151	151
Cinema/Entertainment	1.00	0	0	1.00	0	0
Residential	1.00	140	140	1.00	75	75
Hotel	1.00	62	62	1.00	64	64

Table 8-P (O): Internal Person-Trip Origin-Destination Matrix (Computed at Origin)						
Origin (From)	Destination (To)					
	Office	Retail	Restaurant	Cinema/Entertainment	Residential	Hotel
Office		66	13	0	7	0
Retail	1		10	1	9	2
Restaurant	5	62		12	27	11
Cinema/Entertainment	0	0	0		0	0
Residential	3	32	16	0		2
Hotel	0	10	44	0	1	

Table 8-P (D): Internal Person-Trip Origin-Destination Matrix (Computed at Destination)						
Origin (From)	Destination (To)					
	Office	Retail	Restaurant	Cinema/Entertainment	Residential	Hotel
Office		2	4	0	6	0
Retail	21		54	0	64	11
Restaurant	20	14		0	22	44
Cinema/Entertainment	4	1	6		6	1
Residential	38	3	26	0		7
Hotel	0	1	9	0	0	

Table 9-P (D): Internal and External Trips Summary (Entering Trips)						
Destination Land Use	Person-Trip Estimates			External Trips by Mode*		
	Internal	External	Total	Vehicles <sup>1</sup>	Transit <sup>2</sup>	Non-Motorized <sup>2</sup>
Office	9	58	67	58	0	0
Retail	20	7	27	7	0	0
Restaurant	39	146	185	146	0	0
Cinema/Entertainment	0	0	0	0	0	0
Residential	37	103	140	103	0	0
Hotel	15	47	62	47	0	0
All Other Land Uses <sup>3</sup>	0	0	0	0	0	0

Table 9-P (O): Internal and External Trips Summary (Exiting Trips)						
Origin Land Use	Person-Trip Estimates			External Trips by Mode*		
	Internal	External	Total	Vehicles <sup>1</sup>	Transit <sup>2</sup>	Non-Motorized <sup>2</sup>
Office	12	316	328	316	0	0
Retail	22	12	34	12	0	0
Restaurant	52	99	151	99	0	0
Cinema/Entertainment	0	0	0	0	0	0
Residential	24	51	75	51	0	0
Hotel	10	54	64	54	0	0
All Other Land Uses <sup>3</sup>	0	0	0	0	0	0

<sup>1</sup>Vehicle-trips computed using the mode split and vehicle occupancy values provided in Table 2-P

<sup>2</sup>Person-Trips

<sup>3</sup>Total estimate for all other land uses at mixed-use development site is not subject to internal trip capture computations in this estimator

\*Indicates computation that has been rounded to the nearest whole number.